

User Manual

3-Phase Hybrid Inverter

SH5.0RT/SH6.0RT/SH8.0RT/SH10RT/SH5.0RT-20/
SH6.0RT-20/SH8.0RT-20/SH10RT-20



All Rights Reserved

All Rights Reserved

No part of this document can be reproduced in any form or by any means without the prior written permission of Sungrow Power Supply Co., Ltd (hereinafter "SUNGROW").

Trademarks

SUNGROW and other Sungrow trademarks used in this manual are owned by SUNGROW.

All other trademarks or registered trademarks mentioned in this manual are owned by their respective owners.

Software Licenses

- It is prohibited to use data contained in firmware or software developed by SUNGROW, in part or in full, for commercial purposes by any means.
- It is prohibited to perform reverse engineering, cracking, or any other operations that compromise the original program design of the software developed by SUNGROW.

About This Manual

The manual mainly contains the product information, as well as guidelines for installation, operation, and maintenance. The manual does not include complete information about the photovoltaic (PV) system. Readers can get additional information at www.sungrowpower.com or on the webpage of the respective component manufacturer.

Validity

This manual is valid for the following model of low-power grid-connected PV string inverters:

- SH5.0RT
- SH6.0RT
- SH8.0RT
- SH10RT
- SH5.0RT-20
- SH6.0RT-20
- SH8.0RT-20
- SH10RT-20

It will be referred to as "inverter" hereinafter unless otherwise specified.

Target Group

This manual is intended for professional technicians who are responsible for installation, operation, and maintenance of inverters, and users who need to check inverter parameters.

The inverter must only be installed by professional technicians. The professional technician is required to meet the following requirements:

- Know electronic, electrical wiring and mechanical expertise, and be familiar with electrical and mechanical schematics.
- Have received professional training related to the installation and commissioning of electrical equipment.
- Be able to quickly respond to hazards or emergencies that occur during installation and commissioning.
- Be familiar with local standards and relevant safety regulations of electrical systems.
- Read this manual thoroughly and understand the safety instructions related to operations.

How to Use This Manual

Please read this manual carefully before using the product and keep it properly at a place for easy access.

All contents, pictures, marks, and symbols in this manual are owned by SUNGROW. No part of this document may be reprinted by the non-internal staff of SUNGROW without written authorization.

Contents of this manual may be periodically updated or revised, and the actual product purchased shall prevail. Users can obtain the latest manual from support.sungrowpower.com or sales channels.

Symbols

This manual contains important safety instructions, which are highlighted with the following symbols, to ensure personal and property safety during usage, or to help optimize the product performance in an efficient way.

Please carefully understand the meaning of these warning symbols to better use the manual.

DANGER

Indicates high-risk potential hazards that, if not avoided, may lead to death or serious injury.

WARNING

Indicates moderate-risk potential hazards that, if not avoided, may lead to death or serious injury.

CAUTION

Indicates low-risk potential hazards that, if not avoided, may lead to minor or moderate injury.

NOTICE

Indicates potential risks that, if not avoided, may lead to device malfunctions or financial losses.



“NOTE” indicates additional information, emphasized contents or tips that may be helpful, e.g., to help you solve problems or save time.

Contents

All Rights Reserved	I
About This Manual	II
1 Safety Instructions	1
1.1 Unpacking and Inspection	2
1.2 Installation Safety	2
1.3 Electrical Connection Safety	3
1.4 Operation Safety	5
1.5 Maintenance Safety	5
1.6 Disposal Safety	6
2 Product Description	7
2.1 System Introduction	7
2.2 Product Introduction	7
2.3 Symbols on the Product	9
2.4 LED Indicator	10
2.5 DC Switch	10
2.6 PV Energy Storage System (PV ESS)	11
2.6.1 PV ESS Introduction	11
2.6.2 Declaration For Back-Up Function	12
2.6.3 Energy Management	13
2.7 Parallel System	15
2.7.1 Grid-connected Parallel System	15
2.7.2 Off-grid Parallel System	17
2.8 PV Storage and EV-Charging System	20
2.9 Retrofitting the Existing PV System	21
2.10 Retrofitted PV Storage and EV-Charging System	23
3 Function Description	24
3.1 Safety Function	24
3.1.1 Protection	24
3.1.2 Earth Fault Alarm	24
3.2 Energy Conversion and Management	24
3.2.1 Power Derating	24

3.2.2 DRM (“AU”/“NZ”).....	25
3.2.3 Regular Operational Voltage Range	25
3.2.4 Regular Operational Frequency Range	26
3.2.5 Reactive Power Regulation	26
3.2.6 Load Control	26
3.3 Battery Management	26
3.3.1 Charge Management.....	28
3.3.2 Discharge Management.....	29
3.4 Communication and Configuration	30
3.5 EV Charger Management.....	30
4 Unpacking and Storage	31
4.1 Unpacking and Inspection	31
4.2 Scope of Delivery	32
4.3 Inverter Storage	33
5 Mechanical Mounting	34
5.1 Safety During Mounting.....	34
5.2 Location Requirements	35
5.2.1 Environment Requirements.....	35
5.2.2 Carrier Requirements	35
5.2.3 Angle Requirements.....	36
5.2.4 Clearance Requirements	36
5.3 Installation Tools.....	37
5.4 Moving the Inverter	38
5.5 Installing the Inverter.....	39
6 Electrical Connection	41
6.1 Safety Instructions	41
6.2 Terminal Description	42
6.3 Electrical Connection Overview	45
6.4 External Protective Grounding Connection	48
6.4.1 External Protective Grounding Requirements	49
6.4.2 Connection Procedure.....	49
6.5 AC Cable Connection	51
6.5.1 AC Side Requirements	51
6.5.2 Assembling the AC Connector	51
6.5.3 Installing the AC Connector.....	54
6.6 DC Cable Connection	55

6.6.1 PV Input Configuration	57
6.6.2 Assembling the PV Connectors	58
6.6.3 Installing PV Connector	59
6.7 Communication Connection	61
6.7.1 Ethernet Connection.....	61
6.7.2 WiNet-S Connection.....	63
6.7.3 RS485 Connection	66
6.8 Smart Energy Meter Connection	69
6.9 Battery Connection	70
6.9.1 Connecting the Power Cable.....	71
6.9.2 Connecting the CAN Cable	75
6.9.3 Connecting the Enable Cable.....	75
6.10 EV-Charger Communication Connection	75
6.11 DO Connection	76
6.12 DI Connection	77
6.12.1 Assembling the COM Connector	78
6.12.2 Installing the COM Connector.....	80
6.13 Backup Connection.....	81
7 Commissioning	82
7.1 Inspection Before Commissioning.....	82
7.2 Commissioning Procedure	82
7.3 App Preparation	83
7.4 Creating a Plant.....	83
8 iSolarCloud App	92
8.1 Brief Introduction	92
8.2 Installing App	92
8.3 Account Registration.....	93
8.4 Login	94
8.4.1 Requirements	94
8.4.2 Login Procedure	94
8.5 Initial Settings.....	96
8.5.1 Feed-in Limitation	96
8.5.2 Backup Mode.....	96
8.5.3 Reactive Power Regulation Mode.....	96
8.6 Function Overview.....	99
8.7 Home	100
8.8 Run Information.....	102

8.9 Records	103
8.9.1 Chart.....	103
8.9.2 Fault Alarm Record	104
8.9.3 Event Records	105
8.10 Inverter (Optional).....	106
8.11 EV-Charger (Optional).....	107
8.11.1 Driving Distance Per kWh.....	109
8.11.2 Charging Mode.....	109
8.11.3 Parameter Setting	114
8.11.4 Start/Stop Switch.....	115
8.12 More.....	116
8.12.1 System Parameters	117
8.12.2 Running Time	118
8.12.3 Fault Recovery.....	118
8.12.4 Regular Parameters	119
8.12.5 Off-grid Parameters	119
8.12.6 Active Power Regulation	120
8.12.7 Reactive Power Regulation	120
8.12.8 Battery Discharge Time	121
8.12.9 Battery Forced Charge Time	122
8.12.10 Load Control	123
8.12.11 Communication Parameters	124
8.12.12 Firmware Update.....	125
8.12.13 Grounding Detection.....	126
8.12.14 Parallel Configuration	126
8.12.15 Frequency Shift Power Control	127
8.12.16 Energy Management Mode	127
8.12.17 MicroGrid System Parameters.....	128
8.12.18 DO Configuration	130
9 System Decommissioning	131
9.1 Decommissioning the Inverter	131
9.1.1 Disconnecting Inverter.....	131
9.1.2 Dismantling the Inverter.....	131
9.1.3 Disposal of Inverter	132
9.2 Decommissioning the Battery	132
10 Troubleshooting and Maintenance	134

10.1 Troubleshooting.....	134
10.2 Maintenance	139
10.2.1 Maintenance Notices	139
10.2.2 Routine Maintenance.....	140
10.2.3 Replacing the Button Cell.....	140
11 Appendix	142
11.1 Technical Data.....	142
11.2 The Compatibility for Backup under Off-grid Scenario	153
11.3 Quality Assurance.....	154
11.4 Contact Information.....	155

1 Safety Instructions

When installing, commissioning, operating, and maintaining the product, strictly observe the labels on the product and the safety requirements in the manual. Incorrect operation or work may cause:

- Injury or death to the operator or a third party.
- Damage to the product and other properties.

WARNING

- **Do not operate the product and cables (including but not limited to moving the product, installing the product, operating the product and cables, powering up the product, maintaining the product, and working at heights) in harsh weather conditions such as lightning, rain, snow, and level 6 or stronger wind.**
- **In case of fire, evacuate from the building or product area and call the fire alarm. Re-entry into the burning area is strictly prohibited under any circumstances.**

NOTICE

- **Tighten the screws with the specified torque using tools when fastening the product and terminals. Otherwise, the product may be damaged. And the damage caused is not covered by the warranty.**
- **Learn how to use tools correctly before using them to avoid hurting people or damaging the device.**
- **Maintain the device with sufficient knowledge of this manual and use proper tools.**



- The safety instructions in this manual are only supplements and cannot cover all the precautions that should be followed. Perform operations considering actual onsite conditions.
- SUNGROW shall not be held liable for any damage caused by violation of general safety operation requirements, general safety standards, or any safety instruction in this manual.
- When installing, operating, and maintaining the product, comply with local laws and regulations. The safety precautions in this manual are only supplements to local laws and regulations.

1.1 Unpacking and Inspection

WARNING

- Check all safety signs, warning labels and nameplates on devices.
- The safety signs, warning labels and nameplates must be clearly visible and cannot be removed or covered before the device is decommissioned.

NOTICE

After receiving the product, check whether the appearance and structural parts of the device are damaged, and check whether the packing list is consistent with the actual ordered product. If there are problems with the above inspection items, do not install the device and contact your distributor first. If the problem persists, contact SUNGROW in time.

1.2 Installation Safety

DANGER

- Make sure there is no electrical connection before installation.
- Before drilling, avoid the water and electricity wiring in the wall.

CAUTION

Improper installation may cause personal injury!

- If the product supports hoisting transport and is hoisted by hoisting tools, no one is allowed to stay under the product.
- When moving the product, be aware of the product weight and keep the balance to prevent it from tilting or falling.

NOTICE

Before operating the product, must check and ensure that tools to be used have been maintained regularly.

1.3 Electrical Connection Safety

DANGER

Before electrical connections, please make sure that the inverter is not damaged, otherwise it may cause danger!

Before electrical connections, please make sure that the inverter switch and all switches connected to the inverter are set to "OFF", otherwise electric shock may occur!

DANGER

The PV string will generate lethal high voltage when exposed to sunlight.

- Operators must wear proper personal protective equipment during electrical connections.
- Must ensure that cables are voltage-free with a measuring instrument before touching DC cables.
- Respect all safety instructions listed in relevant documents about PV strings.

DANGER

Danger to life due to a high voltage inside the inverter!

- Be sure to use special insulation tools during cable connections.
- Note and observe the warning labels on the product, and perform operations strictly following the safety instructions.
- Respect all safety instructions listed in this manual and other pertinent documents.

DANGER

If the battery is short-circuited, the instantaneous current will be excessively high and a large amount of energy will be released, which may cause fire and personal injury.

Disconnect the battery from all voltage sources prior to performing any work on the battery.

Lethal voltages are present at the battery terminals and cables connecting to the inverter. Severe injuries or death may occur if the cables and terminals in the inverter are touched.

Observe all safety information provided by the battery manufacturer.

⚠ WARNING

Damage to the product caused by incorrect wiring is not covered by the warranty.

- **Electrical connection must be performed by professionals.**
- **Please use measuring devices with an appropriate range. Overvoltage can damage the measuring device and cause personal injury.**
- **All cables used in the PV generation system must be firmly attached, properly insulated, and adequately dimensioned.**
- **Do not damage the ground conductor. Do not operate the product in the absence of a properly installed ground conductor. Otherwise, it may cause personal injury or product damage.**

⚠ WARNING

Check the positive and negative polarity of the PV strings, and connect the PV connectors to corresponding terminals only after ensuring polarity correctness.

During the installation and operation of the inverter, please ensure that the positive or negative poles of PV strings do not short-circuit to the ground. Otherwise, an AC or DC short-circuit may occur, resulting in equipment damage. The damage caused by this is not covered by the warranty.

The interfaces of the battery in the system must be compatible with the inverter.

The entire battery voltage range must be completely within the permissible range of the inverter, and the battery voltage shall not exceed the maximum permissible DC input voltage of the inverter.

NOTICE

- **Comply with the safety instructions related to PV strings and the regulations related to the local grid.**
- **Install the external protective grounding cable first when performing electrical connection and remove the external protective grounding cable last when removing the inverter.**

1.4 Operation Safety

DANGER

When routing cables, ensure a distance of at least 30 mm between the cables and heat-generating components or areas to protect the insulation layer of cables from aging and damage.

When the product is working:

- Do not touch the product enclosure.
- It is strictly forbidden to plug and unplug any connector on the inverter.
- Do not touch any wiring terminal of the inverter. Otherwise, electric shock may occur.
- Do not disassemble any parts of the inverter. Otherwise, electric shock may occur.
- It is strictly forbidden to touch any hot parts of the inverter (such as the heat sink). Otherwise, it may cause burns.
- Do not connect or remove any battery. Otherwise, electric shock may occur.
- Do not connect or remove any PV string or any PV module in a string. Otherwise, electric shock may occur.
- If the inverter is equipped with a DC switch, do not operate it. Otherwise, it may cause device damage or personal injury.

1.5 Maintenance Safety

DANGER

Risk of inverter damage or personal injury due to incorrect service!

- Before maintenance, disconnect the AC circuit breaker on the grid side and then the DC switch. If a fault that may cause personal injury or device damage is found before maintenance, disconnect the AC circuit breaker and wait until the night before operating the DC switch. Otherwise, a fire inside the product or an explosion may occur, causing personal injuries.
- After the inverter is powered off for 10 minutes, measure the voltage and current with professional instrument. Only when there is no voltage nor current can operators who wear protective equipment operate and maintain the inverter.
- Even if the inverter is shut down, it may still be hot and cause burns. Wear protective gloves before operating the inverter after it cools down.

⚠ DANGER

Touching the power grid or the contact points and terminals on the inverter connected to the power grid may lead to electric shock!

- The power grid side may generate voltage. Always use a standard voltmeter to ensure that there is no voltage before touching.

⚠ CAUTION

To prevent misuse or accidents caused by unrelated personnel, post prominent warning signs or demarcate safety warning areas around the product.

NOTICE

To avoid the risk of electric shock, do not perform any other maintenance operations beyond those described in this manual. If necessary, contact your distributor first. If the problem persists, contact SUNGROW. Otherwise, the losses caused is not covered by the warranty.

NOTICE

Improper settings or maintenance can permanently damage the battery. Incorrect inverter parameters will lead to the premature aging of battery.

NOTICE

- If the paint on the inverter enclosure falls or rusts, repair it in time. Otherwise, the inverter performance may be affected.
- Do not use cleaning agents to clean the inverter. Otherwise, the inverter may be damaged, and the loss caused is not covered by the warranty.
- As the inverter contains no parts that can be maintained, never open the enclosure of the inverter or replace any internal components without authorization. Otherwise, the loss caused is not covered by the warranty.

1.6 Disposal Safety

⚠ WARNING

Please scrap the product in accordance with relevant local regulations and standards to avoid property losses or casualties.

2 Product Description

2.1 System Introduction

⚠ WARNING

- The inverter must only be operated with PV strings with class II protection in accordance with IEC 61730, application class A. It is not allowed for the positive pole or the negative pole of the PV strings to be grounded. This can cause the inverter to be destroyed.
- Do not connect any local load between the inverter and the AC circuit breaker.

NOTICE

For the TT utility grid, the N line voltage to ground must be 30 V or less.
The inverter applies only to the scenarios described in this manual.

The three-phase hybrid inverters are applicable to both on-grid and off-grid PV systems. With the integrated Energy Management System (EMS), they can control and optimize the energy flow so as to increase the self-consumption of the system.

2.2 Product Introduction

Model Description

The model description is as follows (take SH10RT as an example):

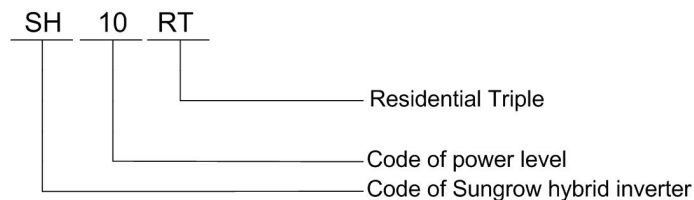

Appearance

The image shown here is for reference only. The actual product received may differ.

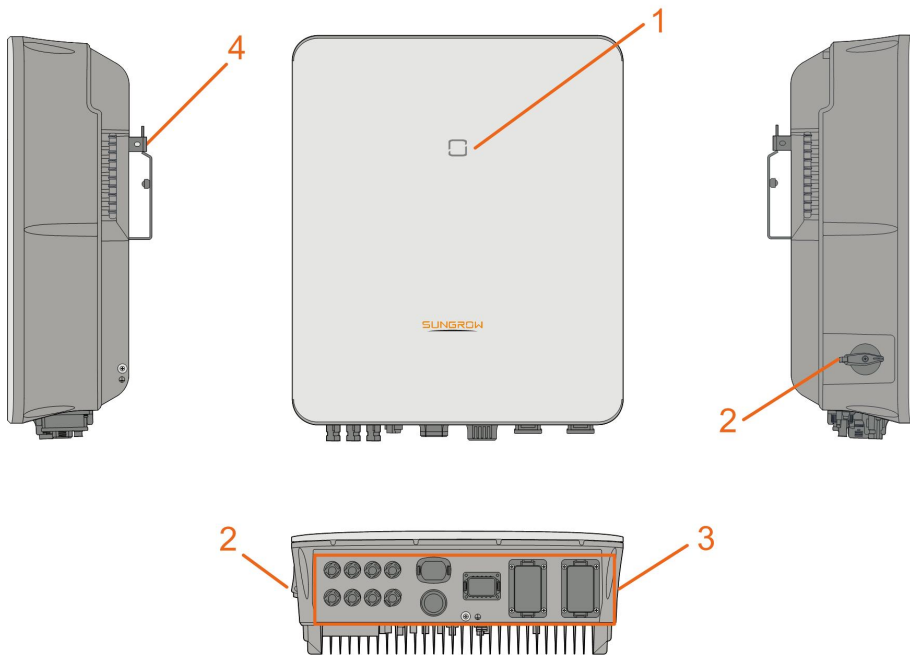

figure 2-1 Inverter Appearance

No.	Name	Description
1	LED indicator panel	Indicates the current working state of the inverter.
2	DC switch(Optional)	Used to disconnect PV - only when there is no PV production.
3	Electrical connection area	Includes DC terminals, AC terminals, battery terminals, communication terminals and additional grounding terminal.
4	Hanger	Used to hang the inverter on the wall-mounting bracket.

Dimensions

The following figure shows the dimensions of the inverter.

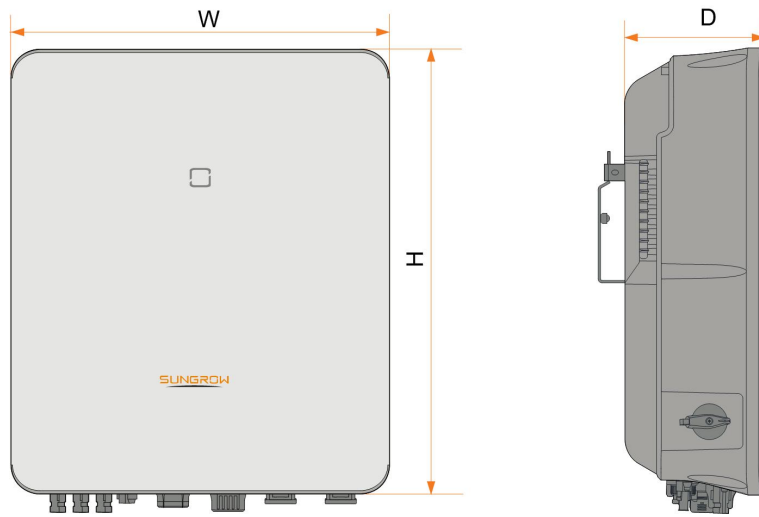













figure 2-2 Dimensions of the Inverter

W(mm)	H(mm)	D(mm)	Weight(kg)
460	540	170	27

2.3 Symbols on the Product



Symbol	Explanation
	RCM mark of conformity.
	TÜV mark of conformity.
	CE mark of conformity. EU/EEA Importer
	Do not dispose of the inverter together with household waste.
	The inverter does not have a transformer.
	Disconnect the inverter from all the external power sources before maintenance!
	Read the user manual before maintenance!
	Burn danger due to hot surface that may exceed 60°C.

Symbol	Explanation
	Danger to life due to high voltages! Only qualified personnel can open and service the inverter.
	Do not touch live parts for 10 minutes after disconnection from the power sources.
	Additional grounding point.

2.4 LED Indicator

The LED indicator on the front of the inverter indicates the working state of the inverter.

table 2-1 LED Indicator State Description

LED Color	state	Definition
 Blue	ON	The inverter is running in the on/off-grid mode.
	Blink	The inverter is at standby or startup state (without on/off-grid operation).
 Red	ON	A system fault has occurred.
 Gray	OFF	Both the AC and DC sides are powered down.

WARNING

Voltage may still be present in AC side circuits after the indicator is off. Pay attention to the electricity safety when operating.

2.5 DC Switch

The DC-Switch is used to disconnect or connect the PV-DC circuit when AC is turned off or DC current is below 0,5A.

The inverter operates automatically when input and output requirements are met. Rotate the DC switch to the “OFF” position to stop the inverter when a fault occurs. When you need to stop the inverter normally please first turn off AC and shut down the hybrid via app.



Turn the DC switch to the “ON” position before restarting the inverter.

2.6 PV Energy Storage System (PV ESS)

NOTICE

When designing the system, ensure that the operating ranges of all devices that are connected to the inverter meet the requirements of the inverter.

2.6.1 PV ESS Introduction

By directly connecting a battery module to the inverter, the conventional PV system can be upgraded to be an Energy Storage System (ESS).

The system is capable of operating off-grid to ensure an emergency power supply for protected loads in the event of a grid interruption or blackout, which may be caused by:

- islanding;
- under-voltage;
- under-frequency or over-frequency.

NOTICE

- **Under any connection, either grid-connection or off-grid application, please be sure that the potential voltage between N and PE line is not higher than 30V, otherwise, inverter will stop generating power.**
- **The system is not suitable for supplying life-sustaining medical devices. It cannot guarantee backup power in all circumstances.**

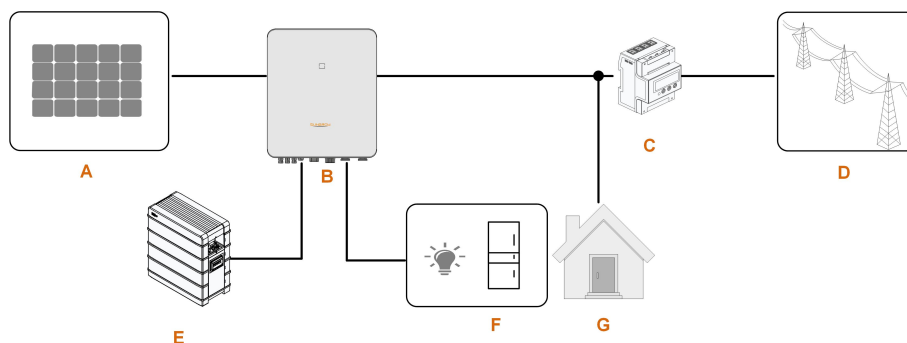

figure 2-3 PV Energy Storage System (PV ESS)

table 2-2 System Compositions

Item	Description	Remark
A	PV strings	Compatible with monocrystalline silicon, polycrystalline silicon, and thin-film without grounding.
B	Inverter	SH5.0-10RT/SH5.0-10RT-20
C	Three-phase Smart Energy Meter	Measures the export power and communicates with the inverter via the RS485 port.
D	Utility grid	Grid grounding system types: TT, TN, TN-C-S, TN-S, TN-C, the type of grid grounding system depends on local regulations.
E	Battery (optional)	A Li ion battery from the compatibility list.
F	Backup loads	Protected house loads directly connected to the inverter.
G	Normal Loads	Non protected house loads, they will disconnect in case of grid failure.

2.6.2 Declaration For Back-Up Function

⚠ DANGER

This product is not suitable for supplying power to life-sustaining medical devices since power outages may result in danger to life.

The following statement involves SUNGROW general policies about the hybrid inverters described in this document.

- 1 For hybrid inverters, the electrical installation typically includes connection of the inverter to both PV modules and batteries. If there is no available power from batteries or PV modules in backup mode, the backup power supply will be automatically terminated. SUNGROW shall hold no liability for any consequences arising from failing to observe this instruction.

- 2 Normally, the Back-Up switching time is less than 20 ms. However, some external factors or local regulations may cause the system to fail on Back-Up mode. Therefore, the users must be aware of conditions and follow the instructions as below:
- Do not connect loads that are dependent on a stable energy supply for a reliable operation.
 - Do not connect the loads whose total capacity is greater than the maximum Back-Up capacity.
 - Do not connect the loads that may cause very high start-up current surges, such as non-frequency conversion air conditioning, vacuum cleaner or half-wave loads such as hair dryer, heat gun, hammer drill. Refer to "[11.2 The Compatibility for Backup under Off-grid Scenario](#)" for recommended loads.
 - Due to the condition of the battery itself, battery current might be limited by some factors, including but not limited to the temperature and weather.

Declaration For Back-Up Overload Protection

The inverter will restart in case of overload protection. The time required for restarting will increase (5 min at most) if overload protection repeats. Try to reduce Back-Up load power within maximum limitation or remove the loads which may cause very high start-up current surges.

2.6.3 Energy Management

The battery discharges to provide energy to loads. If the battery is empty or there is not enough power from the battery system, the grid shall supply power to backup loads and normal loads.

When the grid is present, the bypass function of the hybrid inverter is activated and the Backup loads will be directly connected to the grid via the bypass switch integrated in the inverter.

If the Smart Energy Meter is abnormal or not equipped, the inverter will run normally, however, the battery can be charged but not allowed to discharge. In this case the feed-in power setting will be ineffective, and the DO function for optimized mode will be disabled.

Energy Management during Daytime

The energy management system (EMS) works in self-consumption mode by default.

- Scenario 1: PV power generation \geq Load power consumption
 - First, PV power will go to Backup loads first, then normal loads and the battery.
 - Moreover, If the battery is fully charged, the excess will go to the grid. The feed-in power will not surpass the feed-in limitation value in initial settings.
- Scenario 2: PV power generation $<$ Load power consumption
 - First, battery will discharge and provide the energy missing.
 - Moreover, inverter will draw power from the mains if the power from the PV and battery is less than the load power.

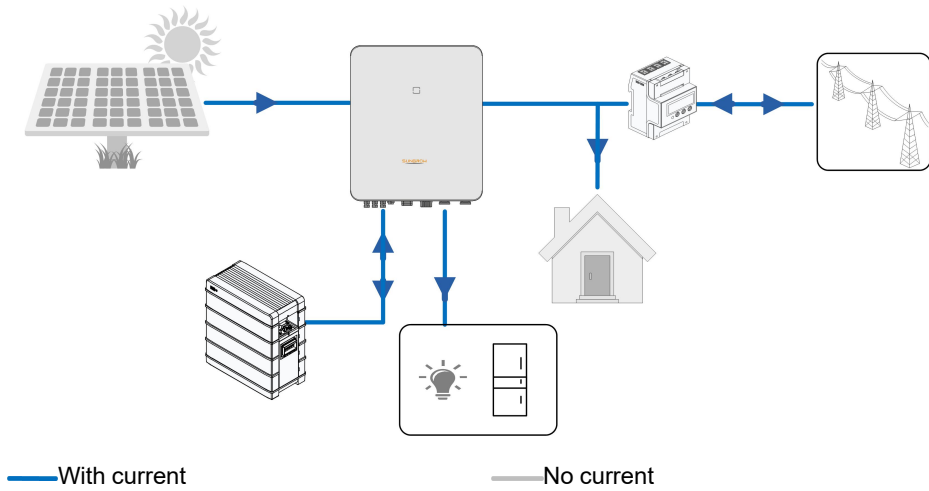

Energy Management during Night

During night, with energy available, the battery will discharge to supply power for loads. Alternatively, the grid will supply power for the loads in case the discharge power of the battery is insufficient.

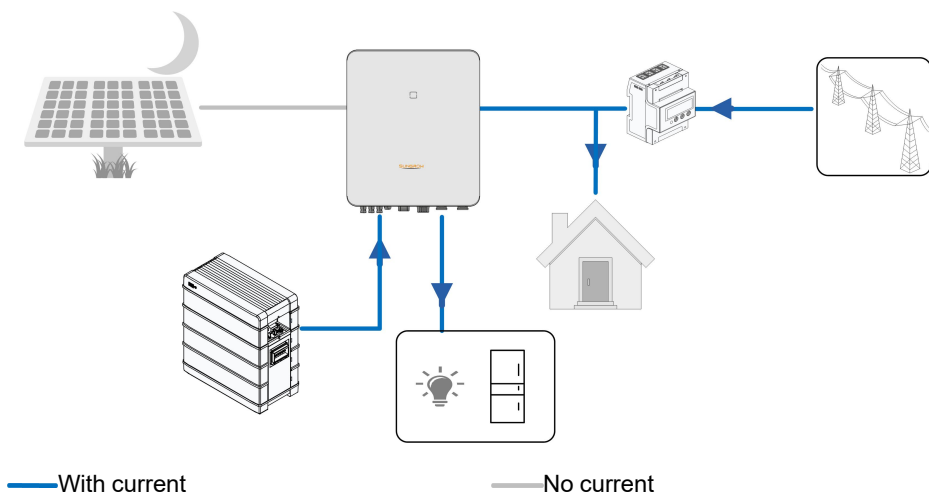

During night, when the battery is empty, it will enter into standby mode. In this case, the grid will supply all power for loads.

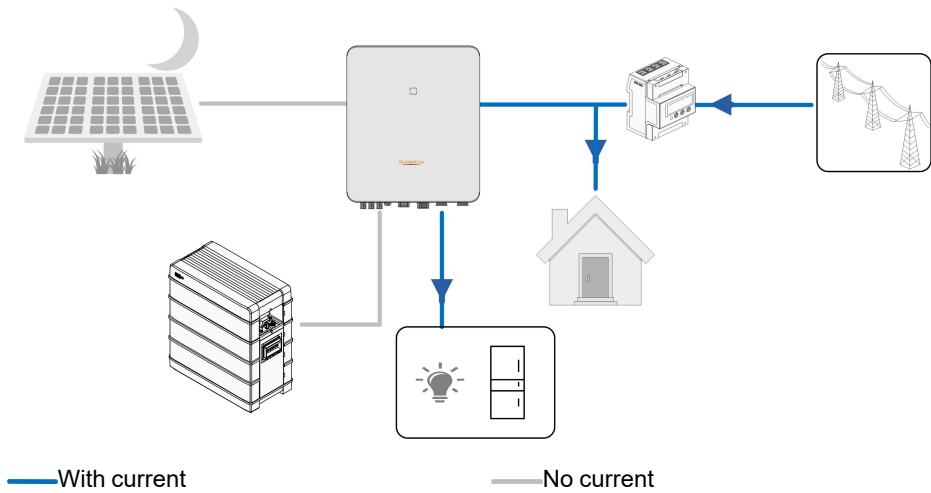

2.7 Parallel System

2.7.1 Grid-connected Parallel System

Maximum five hybrid inverters with the same type can be connected in parallel in the PV ESS via RS485 communication. Each hybrid inverter will independently provide power to loads attached at the backup-port in case of a grid outage.

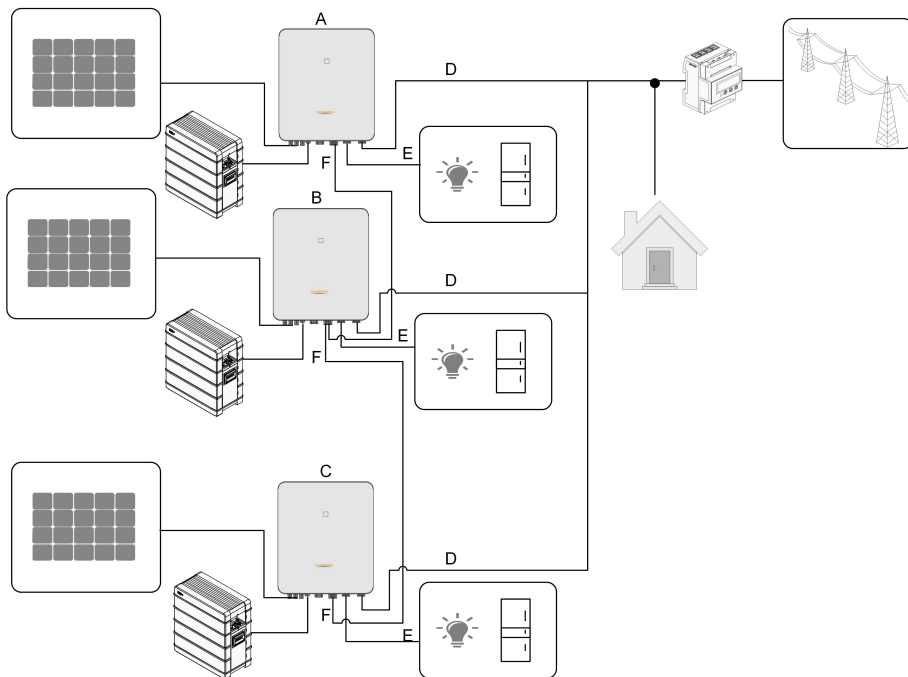

figure 2-4 Parallel PV ESS

(A) Master

(B) Slave 1

(C) Slave 2

(D) GRID

(E) BACK-UP

(F) RS485



Only the hybrid GRID terminals can be connected in parallel, the BACK-UP terminals and the battery terminals cannot be connected together. Each hybrid must have its own BACK-UP loads. The Backup loads of each inverter should not exceed its nominal power.

Refer to "[6.7.3 RS485 Connection](#)" for the cable connection.

In an on-grid parallel system, the master inverter collects information from Smart Energy Meter and slave inverter and performs the energy management including:

- Feed-in power control.
- Battery charge / discharge
- Maximum power limitation

The following settings are required for the inverter parallel function.

- Feed-in power control. The feed-in power control function refers to "[8.5.1 Feed-in Limitation](#)". The PV installation power of the master inverter is the total installation power of the system, the slave inverters do not need to set the feed-in power.

- Ripple Control. The Ripple Control device only needs to be connected to the master inverter, which will perform unified scheduling. Refer to "[6.12 DI Connection](#)" for the cable connection. Refer to "[8.12.6 Active Power Regulation](#)" to enable it in the iSolarCloud App.
- Parallel Configuration. Refer to "[8.12.14 Parallel Configuration](#)" to configure the master and slave inverters in the iSolarCloud App.

2.7.2 Off-grid Parallel System



- This section is not applicable for Europe but only for other regions. Please contact SUNGROW for details of specific regions and models.

In off-grid parallel mode, devices are controlled by the smart switch at the grid-connected point, and relevant parameters can be set on iSolarCloud App.

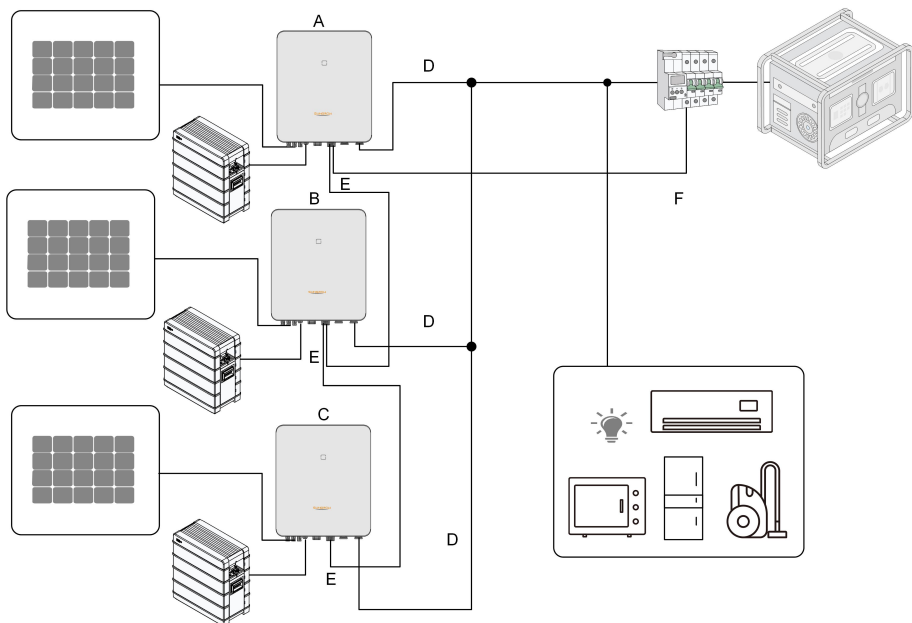

figure 2-5 Off-grid Centralized with Load

(A) Master

(B) Slave 1

(C) Slave 2

(D) GRID

(E) RS485

(F) RS485 for Smart Switch



- Batteries in parallel are temporarily not to be connected to inverters.
- Each inverter in the parallel system must be connected with batteries.
- In off-grid parallel mode, SOC equalization of batteries connected to each inverter is not supported.
- The sum of the total power of inverters and the load power shall not exceed the nominal power of the genset.

Only 2~5 inverters can be connected in parallel. If inverters of the same power are connected in parallel, the output power is the sum of the power of each inverter. If inverters of different power are connected in parallel, the output power is the product of the minimum power value of a single inverter and the number of inverters.

Eg. If five inverters of 10kW are connected in parallel, the output power is 50kW; If three inverters of 10kW and one of 8kW are connected in parallel, the output power is 4 times 8kW, that is, 32kW.

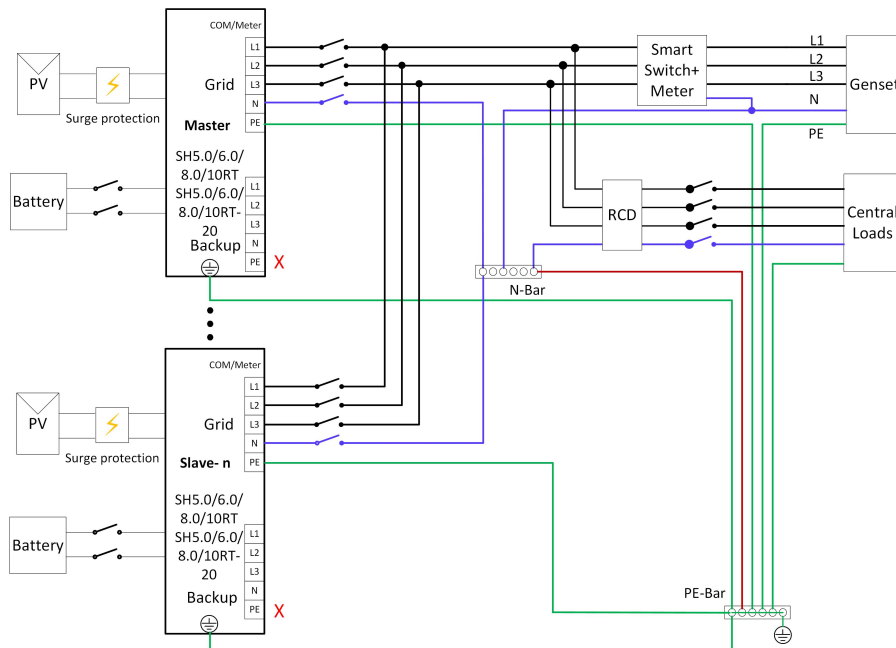

figure 2-6 Wiring diagram for Australia and New Zealand

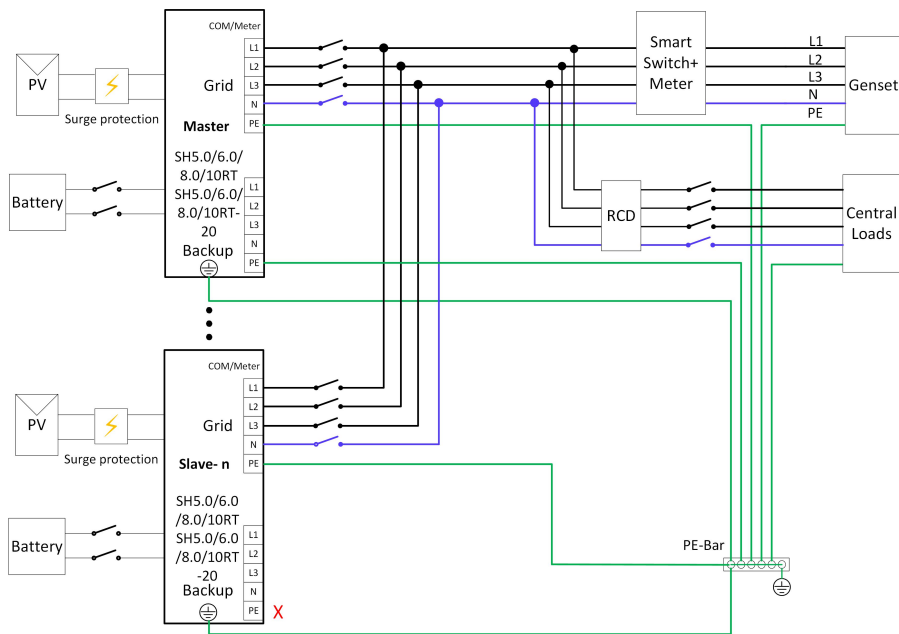

figure 2-7 Wiring diagram for other regions *

* Ensure that only the PE cable at the backup port of the master inverter is grounded in regions beyond Australia and New Zealand.

NOTICE

If there is more than one inverter in the system, the backup terminal of inverters cannot be connected to loads, nor can they be connected in parallel. If there is only one inverter in the system, the load should be connected to the backup terminal. For the wiring of other terminals, please refer to the wiring of the master inverter in the off-grid parallel system above.



- In MicroGrid mode, the grid-connected port can only be connected to the genset, not to the grid.
- In MicroGrid mode, the smart switch is necessary.
- If the number of connected inverters is different from the number set on the master inverter, the system may fail to start.

The master inverter is connected to the smart switch and the meter through RS485 communication for the system to control the smart switch. For details about cable connections. Refer to "6.7.3 RS485 Connection".

The following settings are required for the off-grid parallel connection of inverters:

- Off-grid mode enabling. Refer to "[8.12.5 O_Off-grid_Parameters.dita](#)". The off-grid mode is off by default and can be enabled first when inverters are turned on.
- Parallel configuration. Refer to "[8.12.14 Parallel Configuration](#)" to configure the master and slave inverters on iSolarCloud App. If there is only one inverter in the system, disable the parallel configuration function.
- MicroGrid mode enabling. Refer to "[8.12.18 Energy Management Mode](#)". In MicroGrid mode, select MicroGrid System Mode in DO Configuration referring to "[8.12.18 DO Configuration](#)" to control the start and stop of the genset.
- SOC control setting. Refer to "[8.12.17 MicroGrid System Parameters](#)". Select "Controlled by SOC" in iSolarCloud App and set the upper and lower limits of SOC to start/stop the genset.

The master inverter controls the start and stop of the genset according to the SOC of each battery. If the SOC of any battery is less than the lower limit for 30s, the genset starts and the system enters the MicroGrid state. If the SOC of all batteries is higher than the upper limit for 30s, the genset stops, and the system enters the off-grid state.



- When the genset is started or stopped, loads will be temporarily short of power (about two and a half minutes), please make preparations in advance.
- Due to overload, the system may fail to start in off-grid mode (black start) or shut down when loads are suddenly connected. If so, notice that the startup load or the sudden switching load power should be less than 50% of the nominal power of the parallel system, and the rest of load can be connected after the system operate normally 1min later.

2.8 PV Storage and EV-Charging System

A PV storage and charging system with chargers is as follows:

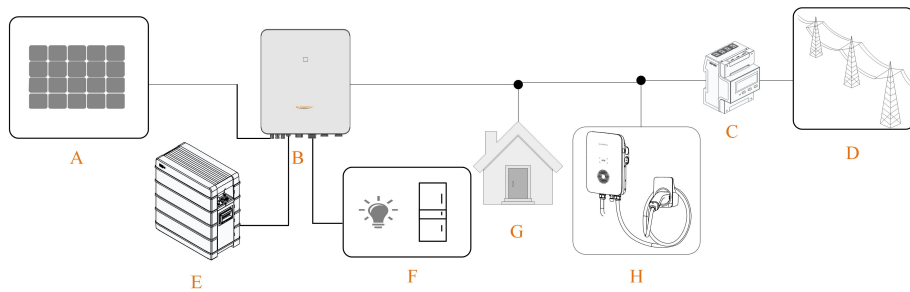

figure 2-8 PV Storage and EV-Charger System

table 2-3 System Compositions

Item	Description	Remark
A	PV strings	Compatible with monocrystalline silicon, polycrystalline silicon, and thin-film without grounding.
B	Inverter	SH5.0RT-20/SH6.0RT-20/SH8.0RT-20/SH10RT-20
C	Three-phase Smart Energy Meter	Measures the export power and communicates with the inverter via the RS485 port.
D	Utility grid	Grid grounding system types: TT, TN, TN-C-S, TN-S, TN-C, the type of grid grounding system depends on local regulations.
E	Battery (optional)	A Li ion battery from the compatibility list.
F	Backup loads	Protected house loads directly connected to the inverter.
G	Normal Loads	Non protected house loads, they will disconnect in case of grid failure.
H	EV-Charger(Optional)	AC011E-01

2.9 Retrofitting the Existing PV System

The hybrid inverter is compatible with any three-phase PV grid-connected inverters. An existing PV system can be retrofitted to be a PV ESS with the addition of the hybrid inverter.

The power generation from the existing PV inverter will be firstly provided to the loads and then charge the battery. With the energy management function of the hybrid inverter, the self-consumption of the new system will be greatly improved.

On-grid Port to Retrofit the Existing PV System

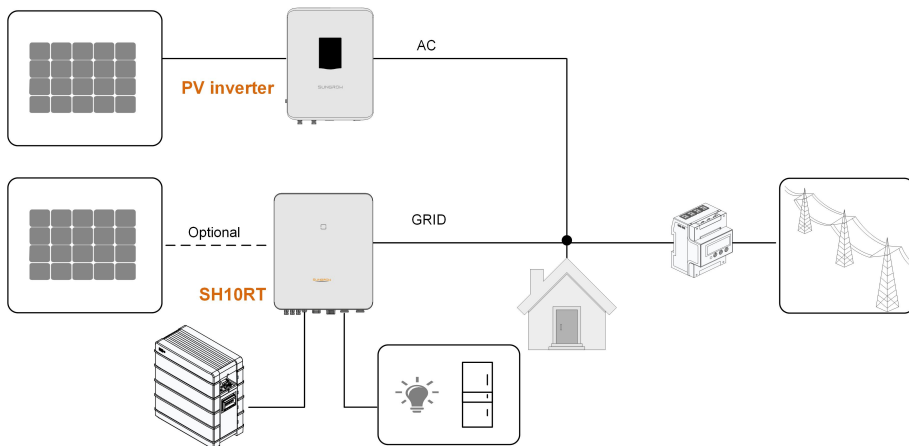

figure 2-9 On-grid Port to Retrofit the Existing PV System

The AC terminal of the PV inverter and the GRID terminal of the hybrid inverter are connected in parallel.

Backup terminal to Retrofit the Existing PV System

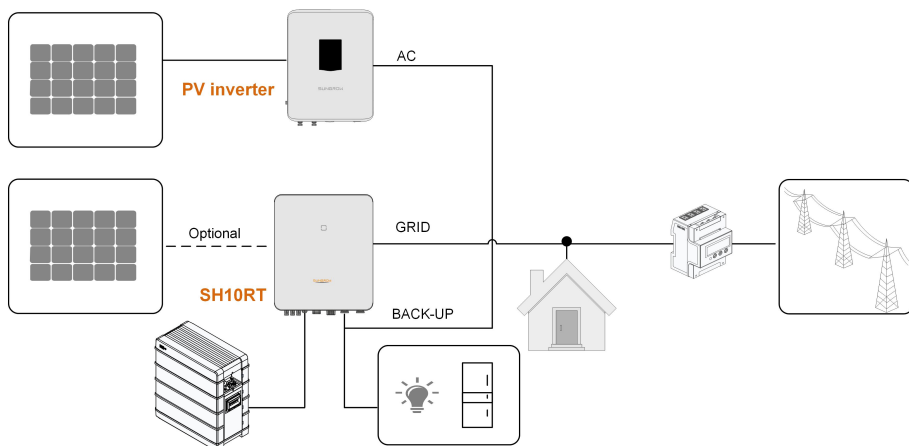

figure 2-10 Backup terminal to Retrofit the Existing PV System

The backup terminal retrofits the existing PV system in order to maximize the use of PV energy by allowing the PV inverter to work even when off-grid.

The AC terminal of the PV inverter and the BACK-UP terminal of the hybrid inverter are connected in parallel. This option is not available in the European region.

The PV inverter power cannot exceed the nominal power of the hybrid inverter (if it is a single-phase PV inverter, the PV inverter power cannot exceed the single-phase nominal power of the three-phase hybrid inverter).

Before retrofitting the existing PV system to an backup terminal, the "Frequency Shift Power Control" parameter needs to be enabled. For details, please refer to ["8.12.15 Frequency Shift Power Control"](#).

Note:

- 1 In zero-export scenario, the hybrid inverter can only ensure no power exported to grid itself but does not ensure zero export for the PV inverter. Please contact the PV inverter manufacturer for its zero-export solution.
- 2 PV modules for hybrid inverter are optional.

2.10 Retrofitted PV Storage and EV-Charging System

The retrofitted PV storage and charging system is as follows:

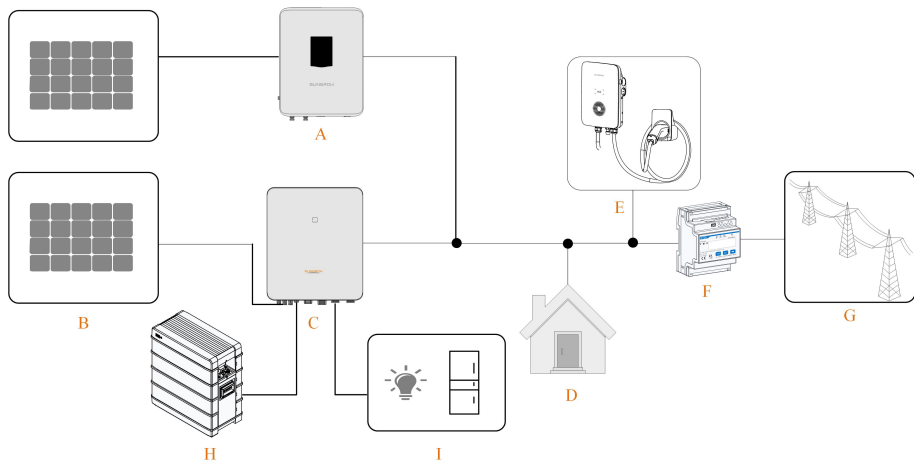

figure 2-11 Retrofitted PV Storage and EV-Charger System

- | | | |
|------------------|----------------|--|
| (A) PV Inverter | (B) PV Strings | (C) SH5.0RT-20/SH6.0RT-20/SH8.0RT-20/SH10RT-20 |
| (D) Home Loads | (E) EV Charger | (F) Smart Energy Meter |
| (G) Utility Grid | (H) Battery | (I) Backup Loads |



If the EV-Charger is connected to one Hybrid inverter, it is not possible to use multiple hybrid inverters in parallel.

3 Function Description

3.1 Safety Function

3.1.1 Protection

Several protective functions are integrated in the inverter, including short circuit protection, grounding insulation resistance surveillance, residual current protection, anti-islanding protection, DC overvoltage / over-current protection, etc.

3.1.2 Earth Fault Alarm

The inverter has integrated a multiple-function dry-contact (DO relay), which can be used for the external alarm for earth fault. The external alarm needs to be powered by the grid.

The additional equipment required is a light indicator and/or a buzzer.

If an earth fault occurs:

- the DO dry-contact will switch on automatically to signal the earth fault alarm;
- the buzzer inside the inverter will also beep;
- the Ethernet communication port can be used for transmitting the alarm remotely.

3.2 Energy Conversion and Management

The inverter converts the DC power from the PV array or the battery to the AC power, in conformity with the grid requirements. It also transmits the DC power from the PV panel to the battery.

With the bidirectional converter integrated inside, the inverter can charge or discharge the battery.

Multiple string MPP trackers are used to maximize the power from PV strings with different orientations, tilts, or module structures.

3.2.1 Power Derating

Power derating is a way to protect the inverter from overload or potential faults. In addition, the derating function can also be activated following the requirements of the utility grid. Situations requiring inverter power derating are:

- over-temperature (including ambient temperature and module temperature)
- high input voltage
- grid under-voltage
- grid over-frequency

- power factor (when values out of the rated values)
- high altitude

3.2.2 DRM (“AU”/“NZ”)

The inverter provides a terminal block for connecting to a demand response enabling device (DRED). The DRED asserts demand response modes (DRMs). The inverter detects and initiates a response to all supported demand response commands within 2s.

The following table lists the DRMs supported by the inverter.

table 3-1 Demand Response Modes (DRMs)

Mode	Explanation
DRM0	The inverter is in the state of “Turn off”.
DRM1	The import power from the grid is 0.
DRM2	The import power from the grid is no more than 50 % of the rated power.
DRM3	The import power from the grid is no more than 75 % of the rated power.
DRM4	The import power from the grid is 100 % of the rated power, but subject to the constraints from other active DRMs.
DRM5	The feed-in power to the grid is 0.
DRM6	The feed-in power to the grid is no more than 50 % of the rated power.
DRM7	The feed-in power to the grid is no more than 75 % of the rated power.
DRM8	The feed-in power to the grid is 100 % of the rated power, but subject to the constraints from other active DRMs.

The DRED may assert more than one DRM at a time. The following shows the priority order in response to multiple DRMs.

Multiple Modes	Priority Order
DRM1...DRM4	DRM1 > DRM2 > DRM3 > DRM4
DRM5...DRM8	DRM5 > DRM6 > DRM7 > DRM8

3.2.3 Regular Operational Voltage Range

The inverters can operate within the allowable voltage range for at least the specified observation time. The setting of the conditions depends on whether the connection is due to a normal operational start-up or an automatic reconnection after disconnection from grid.

When the voltage level is out of the operational and protection levels, the inverter will disconnect within the specified time from the grid. If a disturbance lasts longer than the required protection time, the inverter can reconnect to the grid once the voltage level goes back to normal levels after the disturbance.

3.2.4 Regular Operational Frequency Range

The inverter can operate within its frequency range for at least the specified observation time. The setting of conditions depends on whether the connection is due to a normal operational start-up or an automatic reconnection after disconnection from grid.

When the frequency level is outside the operational and protection levels, the inverter will disconnect from the grid. If a disturbance lasts longer than the required protection time, the inverter can reconnect to the grid once the frequency level goes back to normal levels after the disturbance.

3.2.5 Reactive Power Regulation

The inverter is capable of operating in reactive power regulation modes for the purpose of providing support to the grid. The reactive power regulation mode can be set via the iSolar-Cloud App.

3.2.6 Load Control

The inverter has an integrated multiple-function dry-contact (DO relay), which can be used for load control via a contactor.

User may set the control mode according to individual demand.

- **Timing Mode:** Set the starting time and end time. The DO function will be enabled during the time interval.
- **Switch Mode:** The DO function can be enabled or disabled.
- **Intelligent Mode:** Set the starting time, end time, and the optimized power. During the interval, when the export power reaches to the optimized power, the DO function will be enabled for at least 20 minutes even if the power goes lower. The switch-on can take some time.

3.3 Battery Management

Li-ion battery from SUNGROW, LG Chem, BYD and Pylontech are compatible with the PV ESS , further battery models will be made compatible in the future.

The currently supported battery brands and models are shown in the following table.

Brand	Model	Firmware Version
SUN-GROW	SBR096/128/160/192/224/256	≥ SBRBCU-S_22011.01.05
LG Chem	RESU7H_Type_R	DC-DC converter version ≥ 4.8
	RESU10H_Type_R	Battery management system (BMS) version ≥ 1.7.0.1
BYD	Battery-Box HV 5.1, 6.4, 7.7, 9.0, 10.2, 11.5	≥ V3.013

Brand	Model	Firmware Version
	Battery-Box Premium HVS 5.1, 7.7, 10.2, 12.8	Battery management system (BMS) version \geq 3.16
	Battery-Box Premium HVM 11.0, 13.8, 16.6, 19.3, 22.1	Battery management unit (BMU) ver- sion \geq 3.7
Pylon- tech	Powercube-X1/X2/H1/H2	\geq V4.6
	Force H1/H2	\geq V1.3



The table is continually updated. If the battery model is not in the table, consult SUNGROW if it is supported.

To maximize the battery life, the inverter will perform battery charge, discharge, and battery maintenance based on the battery status communicated by the BMS.

NOTICE

The recommended parameters listed in this section may be updated or revised due to product development. Please refer to the manual supplied by the battery manufacturer for the latest information.

State Definition

In order to avoid overcharging or deep discharging of the battery, three battery statuses according to different voltage ranges has been defined, as shown in the following table.

table 3-2 Battery Status Definition

Type	Port Voltage / SOC		
	Empty	Normal	Full
SUNGROW (SBR096/128/160/ 192/224/256)	SOC < 5 %	5 %...100 % (by default)	SOC = 100 %
LG Chem(RE- SU7H_Type_R) LG Chem(RE- SU10H_Type_R)	SOC < 8 %	8 %...100 % (by default)	SOC = 100 %
BYD (Battery-Box HV)	SOC < 10 %	10 %...100 % (by default)	SOC = 100 %

Type	Port Voltage / SOC		
	Empty	Normal	Full
BYD (Battery-Box Premium HVM / HVS)	SOC < 5 %	5 %...100 % (by default)	SOC = 100 %
Pylontech (Powercube-X1/X2/H1/H2)	SOC < 8 %	8 %...100 % (by default)	SOC = 100 %
Pylontech (Force H1/H2)			

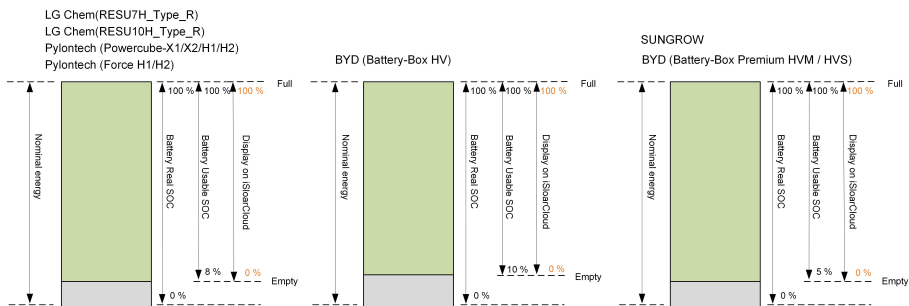

In the off-grid state, the LG Chem battery can only supply power to loads of maximum 5KW (such as RESU10H_Type_R). For the first operation of the inverter with LG Chem battery, either PV or grid needs to power the inverter to activate the LG Chem battery.

The SOC limits of Li-ion batteries can be modified via the iSolarCloud App by qualified personnel.

NOTICE

If the battery has not been used or fully charged for a long time, it is recommended to charge the battery manually every 15 days to at least 15% to ensure battery life and performance.

3.3.1 Charge Management

Backup Charge Management

The emergency charge management function is to protect the battery from the damage caused by long time excessive discharge. The inverter cannot respond to discharge command during emergency charge. The following tables describe the emergency charge conditions for different types of batteries.

table 3-3 Backup Charge Management for Li-ion Battery

Status	Conditions
Trigger	Either of the following conditions is met:
	<ul style="list-style-type: none"> • $SOC \leq (\text{Min. SOC}) - 3\%$ (valid only when the Min. SOC is $\geq 3\%$). • A battery under-voltage warning is triggered. • An emergency charge command is reported to the inverter.
	All the following conditions are met:
Finish	<ul style="list-style-type: none"> • $SOC \geq (\text{Min. SOC}) - 1\%$ (valid only when the Min. SOC is $\geq 3\%$). • The battery under-voltage warning is cleared. • The emergency charge command reported to the inverter is cleared.

table 3-4 Default SOC Conditions for Li-ion Battery Backup Charge

Type	Trigger SOC	Finishing SOC
SUNGROW	$SOC \leq 2\%$	$SOC \geq 4\%$
LG Chem	$SOC \leq 5\%$	$SOC \geq 7\%$
BYD (Battery-Box HV)	$SOC \leq 7\%$	$SOC \geq 9\%$
BYD (Battery-Box Premium HVM / HVS)	$SOC \leq 2\%$	$SOC \geq 4\%$
Pylontech	$SOC \leq 5\%$	$SOC \geq 7\%$

Normal Charge Management

When the battery voltage is within the normal range, the inverter can charge the battery if the PV power is higher than the load power and can ensure that the battery is never over-charged.

The maximum allowable charge current is limited to the smaller value among the following:

- the maximum charge current of the inverter (30A);
- the maximum / recommended charge current from the battery manufacturer.

For this reason, the battery charge power may not reach the nominal power.



- If the PV voltage is higher than 900 V, the battery cannot charge.
- The hybrid inverter will start to charge the battery when the export power value exceeds a pre-defined threshold value of 70 W.

3.3.2 Discharge Management

Discharge management can effectively protect the battery from deep discharging.

The maximum allowable discharge current is limited to the smaller value among the following:

- the maximum discharge current of the inverter (30A);
- the maximum / recommended discharge current from the battery manufacturer.

For this reason, the battery discharge power may not reach the nominal power.



- If the PV voltage is higher than 900 V, the battery cannot discharge.
- The hybrid system will start to discharge the battery when the import power value exceeds a threshold value of 70 W.

3.4 Communication and Configuration

The inverter possesses various ports for device and system monitoring, including RS485, Ethernet, WLAN, and CAN; various parameters can be configured for optimal operation. The inverter information is accessible through the iSolarCloud App.

3.5 EV Charger Management

The currently supported EV Charger brands and models are shown in the following table.

Brand	Model	Firmware Version
SUN-GROW	AC011E-01	≥V1.2.469

4 Unpacking and Storage

4.1 Unpacking and Inspection

The product is thoroughly tested and strictly inspected before delivery. Nonetheless, damage may still occur during shipping. For this reason, please conduct a thorough inspection after receiving the product.

- Check the packing case for any visible damage.
- Check the scope of delivery for completeness according to the packing list.
- Check the inner contents for damage after unpacking.

Contact SUNGROW or the transport company in case of any damage or incompleteness, and provide photos to facilitate services.

Do not dispose of the original packing case. It is recommended to store the device in the original packing case when the product is decommissioned.

NOTICE

- **After receiving the product, check whether the appearance and structural parts of the device are damaged, and check whether the packing list is consistent with the actual ordered product. If there are problems with the above inspection items, do not install the device and contact your distributor first. If the problem persists, contact SUNGROW in time.**
- **If any tool is used for unpacking, be careful not to damage the product.**

4.2 Scope of Delivery

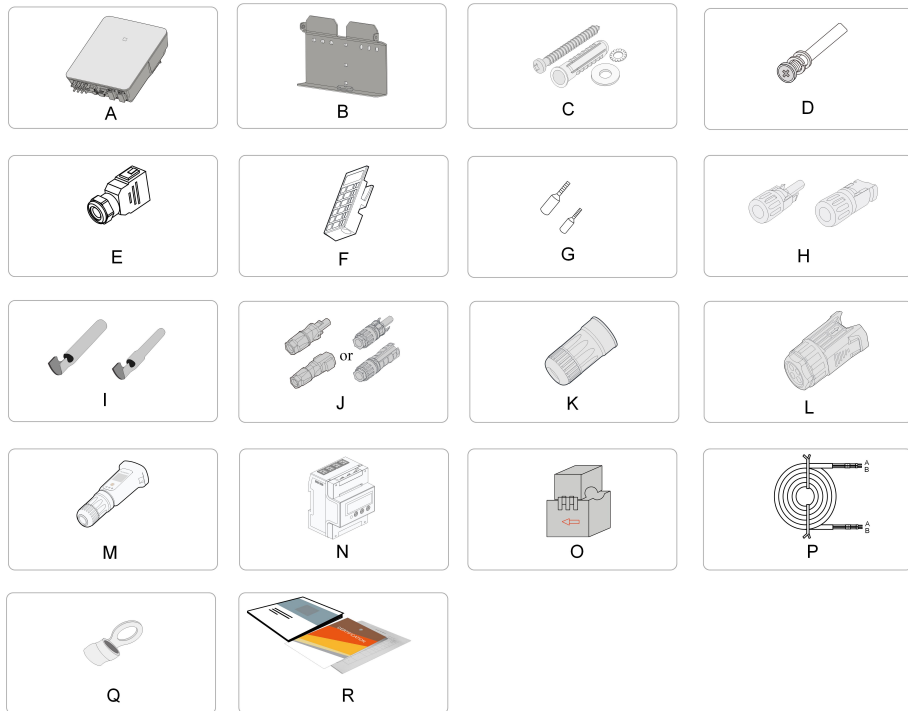

figure 4-1 Scope of delivery

Item	Name	Quantity
A	Inverter	1
B	Wall-mounting bracket *	1
C	Expansion plug set	4
D	M4 screws and washers	2
E	AC/Backup connector set	2
F	Block (Optional)	1
G	Cord end terminal *	-
H	PV connectors	2 ~ 3
I	Crimp contact	2 ~ 3
J	SUNCLIX/Evo2 connector set	1
K	LAN connector set	1
L	COM connector set	1
M	WiNet-S module	1
N	Smart Energy Meter**	1
O	Current Transformer(CT)	3/6 ***
P	RS485 cable	1
Q	OT terminal *	1
R	Documents	1

* The images shown here are for reference. The actual product and quantity are based on delivery.

** SH5.0– 10RT matches DTSU666 smart energy meters, and SH5.0– 10RT-20 matches DTSU666-20 smart energy meters.

*** This accessory is only for SH5.0-10RT-20. The Australia and New Zealand region is equipped with 6 x 100A/0.333V CT as standard, and the other areas are equipped with 3 x 100A/0.333V CT as standard.

4.3 Inverter Storage

Proper storage is required if the inverter is not installed immediately.

- Store the inverter in the original packing case with the desiccant inside.
- The storage temperature must be always between -30°C and +70°C, and the storage relative humidity must be always between 0 and 95 %, non-condensing.
- In case of stacking storage, the number of stacking layers should never exceed the limit marked on the outer side of the packing case.
- The packing case should be upright.
- If the inverter needs to be transported again, pack it strictly before loading and transporting it.
- Do not store the inverter in places susceptible to direct sunlight, rain, and strong electric field.
- Do not place the inverter in places with items that may affect or damage the inverter.
- Store the inverter in a clean and dry place to prevent dust and water vapor from eroding.
- Do not store the inverter in places with corrosive substances or susceptible to rodents and insects.
- Carry out periodic inspections. Inspection shall be conducted at least once every six months. If any insect or rodent bites are found, replace the packaging materials in time.
- If the inverter has been stored for more than a year, inspection and testing by professionals are required before it can be put into operation.

NOTICE

Please store the inverter according to the storage requirements. Product damage caused by failure to meet the storage requirements is not covered by the warranty.

5 Mechanical Mounting

WARNING

Respect all local standards and requirements during mechanical installation.

5.1 Safety During Mounting

DANGER

Make sure there is no electrical connection before installation.
Before drilling, avoid the water and electricity wiring in the wall.

WARNING

Poor installation environment will affect system performance!

- Install the inverter in a well-ventilated place.
- Ensure that the heat dissipation system or vent is not blocked.
- Do not install the inverter in an environment with flammable and explosive objects or smoke.

CAUTION

Improper handling may cause personal injury!

- When moving the inverter, be aware of its weight and keep the balance to prevent it from tilting or falling.
- Wear proper protective equipment before performing operations on the inverter.
- The bottom terminals and interfaces of the inverter cannot directly contact the ground or other supports. The inverter cannot be directly placed on the ground.

NOTICE

When installing devices, ensure that no device in the system causes it hard for the DC switch and the AC circuit breaker to act or hinders maintenance personnel from operating.

If drilling is required during installation:

- Wear goggles and protective gloves when drilling holes.
- Make sure to avoid the water and electricity wiring in the wall before drilling.
- Protect the product from shavings and dust.

5.2 Location Requirements

To a large extent, a proper installation location ensures safe operation, service life, and performance of the inverter.

- The inverter with protection rating IP65 can be installed both indoors and outdoors.
- The inverter should be installed at a height that allows easy viewing of the LED indicator panel, as well as easy electrical connection, operation and maintenance.

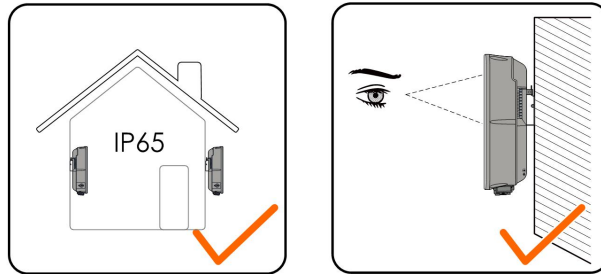

5.2.1 Environment Requirements

- The installation environment must be free of inflammable or explosive materials.
- The location should not be accessible to children.
- The ambient temperature and relative humidity must meet the following requirements.

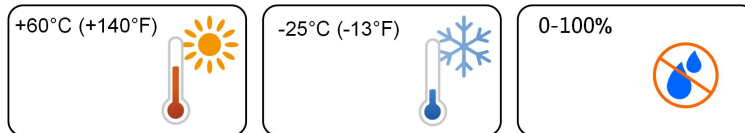

- Install the inverter in a sheltered area to avoid direct sunlight and bad weather (e.g. snow, rain, lightning, etc.). The inverter will derate in high temperature environments for protection. If the inverter is installed in direct sunlight, it may cause power reduction as the temperature rises.
- The inverter should be well ventilated. Ensure air circulation.
- The inverter generates noise during operation and is not recommended to be installed in living areas.

5.2.2 Carrier Requirements

The mounting structure where the inverter is installed must comply with local/national standards and guidelines. Ensure that the installation surface is solid enough to bear four times the weight of the inverter and is suitable for the dimensions of the inverter (e.g. cement walls, plasterboard walls, etc.).



S900-I003

5.2.3 Angle Requirements

Install the inverter vertically. Never install the inverter horizontally, or at forward/backward tilted, or upside down.

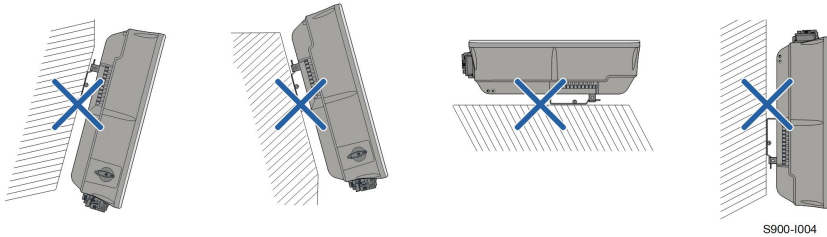

S900-I004

5.2.4 Clearance Requirements

Reserve enough clearance around the inverter to ensure sufficient space for heat dissipation.

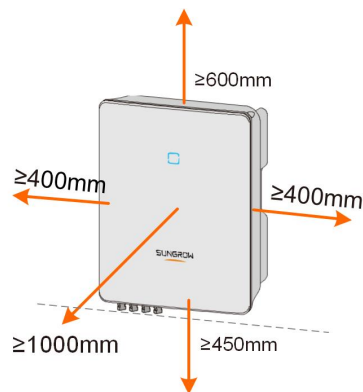

In case of multiple inverters, reserve specific clearance between the inverters.

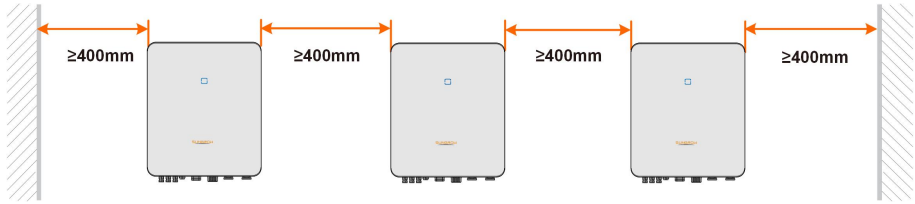

Install the inverter at an appropriate height for ease of viewing LED indicator and operating switch(es).

5.3 Installation Tools

Installation tools include but are not limited to the following recommended ones. If necessary, use other auxiliary tools on site.

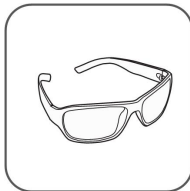

Goggles

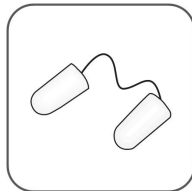

Earplugs

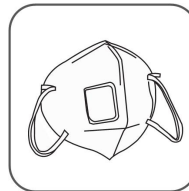

Dust mask



Safety gloves



Safety shoes



Utility knife



Slotted screwdriver
(M4)



Phillips screwdriver
(M4)



Hammer drill
($\phi 10$)

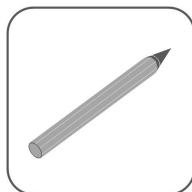

Marker



Vacuum cleaner

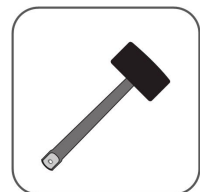

Rubber mallet



Anti-static wrist
strap

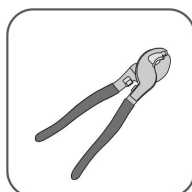

Wire cutter

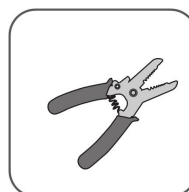

Wire stripper

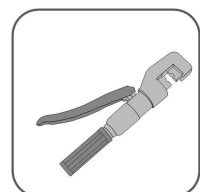

Hydraulic pliers

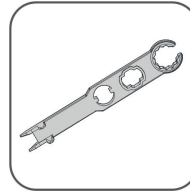

Heat gun

MC4 terminal
crimping tool
4–6mm²

Connector wrench

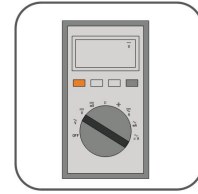
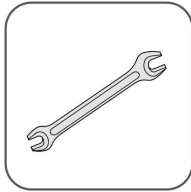
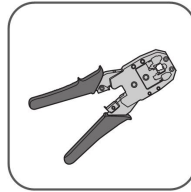
Multimeter
≥ 1000V DCOpen-end wrench
(16 mm, 46 mm)

RJ45 crimping tool

5.4 Moving the Inverter

Before installation, remove the inverter from the packing case and move it to the installation site. Follow the instructions below as you move the inverter:

- Always be aware of the weight of the inverter.
- Lift the inverter using the handles positioned on both sides of the inverter.
- Move the inverter by one or two people or by using a proper transport tool.
- Do not release the equipment unless it has been firmly secured.

⚠ CAUTION

Improper handling may cause personal injury!

- **Arrange an appropriate number of personnel to carry the inverter according to its weight, and installation personnel should wear protective equipment such as anti-impact shoes and gloves.**
- **Attention must be paid to the center of gravity of the inverter to avoid tilting during handling.**
- **Placing the inverter directly on a hard ground may cause damage to its metal enclosure. Protective materials such as sponge pad or foam cushion should be placed underneath the inverter.**
- **Move the inverter by holding the handles on it. Do not move the inverter by holding the terminals.**

5.5 Installing the Inverter

Install the inverter on the wall using the provided wall-mounting bracket and expansion plug sets.

The expansion plug set shown below is recommended for the installation.

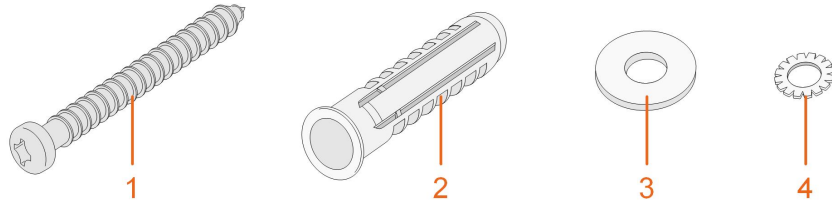

(1) Self-tapping screw (2) Expansion tube (3) Fender washer (4) Spring washer

step 1 Install the wall-mounting bracket.

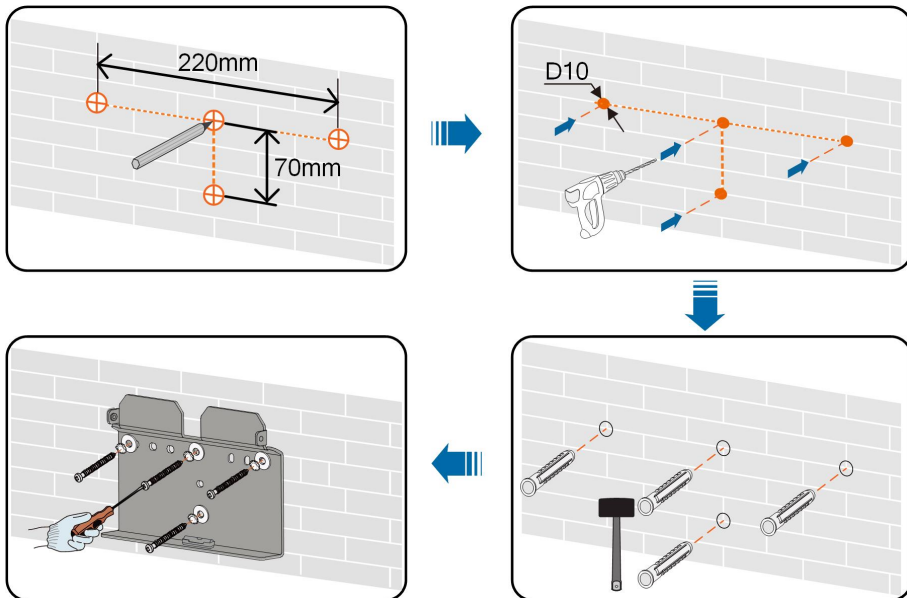

Note:

- 1 The depth of the holes should be about 70 mm.
- 2 The bubble in the bubble level on the mounting-bracket must be centered to ensure that the device will be placed horizontally.

step 2 Mount the inverter to the bracket. Secure the inverter with two M4 screws and washers. (1.5 N•m)

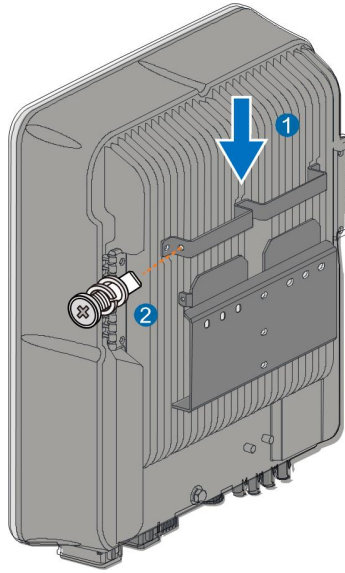

-- End

6 Electrical Connection

6.1 Safety Instructions

DANGER

The PV string will generate lethal high voltage when exposed to sunlight.

- Operators must wear proper personal protective equipment during electrical connections.
- Must ensure that cables are voltage-free with a measuring instrument before touching DC cables.
- Respect all safety instructions listed in relevant documents about PV strings.

DANGER

- Before electrical connections, please make sure that the inverter switch and all switches connected to the inverter are set to "OFF", otherwise electric shock may occur!
- Ensure that the inverter is undamaged and all cables are voltage free before performing electrical work.
- Do not close the AC circuit breaker until the electrical connection is complete.

DANGER

Batteries deliver electric power, resulting in burns or a fire hazard when they are short circuited, or wrongly installed.

Lethal voltages are present at the battery terminals and cables connecting to the inverter. Severe injuries or death may occur if the cables and terminals in the inverter are touched.

WARNING

Damage to the product caused by incorrect wiring is not covered by the warranty.

- Electrical connection must be performed by professionals.
- Operators must wear proper personal protective equipment during electrical connections.
- All cables used in the PV generation system must be firmly attached, properly insulated, and adequately dimensioned.

NOTICE

All electrical connections must comply with local and national / regional electrical standards.

- **Cables used by the user shall comply with the requirements of local laws and regulations.**
- **Only with the permission of the national / regional grid department, the inverter can be connected to the grid.**

NOTICE

- **Before connecting a power cable (such as the AC cable, the DC cable, etc.), confirm that the label and identifier on the power cable are correct.**
- **Please make sure to divide the AC output cable from the DC input cable during the electrical connection to avoid any possible short circuit.**
- **When laying out communication cables, separate them from power cables and keep them away from strong interference sources to prevent communication interruption.**

NOTICE

All vacant terminals must be covered with waterproof covers to prevent affecting the protection rating.

When the wiring is completed, seal the gap of cable inlet and outlet holes with fire-proof / waterproof materials such as fireproof mud to prevent foreign matter or moisture from entering and affecting the long-term normal operation of the inverter. Comply with the safety instructions related to PV strings and the regulations related to the utility grid.



- **If excessive loads are connected to the inverter backup port, the inverter will shut down for protection. Please remove some loads and restart the inverter.**
- **The cable colors in figures in this manual are for reference only. Please select cables according to local cable standards.**

6.2 Terminal Description

All electrical terminals are located at the bottom of the inverter.

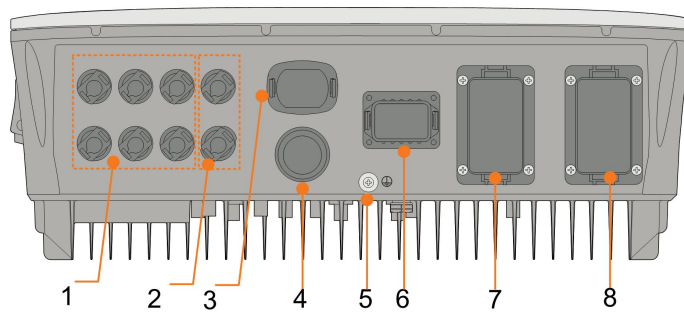

figure 6-1 Terminals at the Bottom of the Inverter

* The image shown here is for reference only. The actual product received may differ.

No.	Name	Description
1	PV terminals	Positive and negative DC input connectors Two or three pairs, depending on the inverter model
2	Battery connection	Connectors for the battery power cables
3	WLAN terminal	Connector for the WiNet—S module
4	LAN terminal	Connector for the EMS, router, and data logger
5	Additional grounding terminal	For reliable grounding
6	COM terminal	Connector for Smart Energy Meter, Sungrow AC011E-01 EV Charger, RS485, BMS/CAN, DRM/DI/Ripple Control Receiver and DO
7	BACK-UP terminal	AC terminal reserved for Backup loads
8	GRID terminal	AC terminal for connection to the utility grid

table 6-1 The label of COM terminal

Meter		BMS/CAN		DI/DRM			DO
A2	B2	H	L	D1/5	D3/7	R	NO
A1	B1	EN_H	EN_G	D2/6	D4/8	C	COM
RS485		Enable					

table 6-2 The label description of COM terminal

No.	Label	Description
1	Meter (A2, B2) ⁽¹⁾	<ul style="list-style-type: none"> Connect to the Smart Energy Meter. (If installing a single inverter or if installing the master inverter in a string of parallel inverters.) Connect to the Sungrow AC011E-01 EV Charger (If the system contains the LG Chem Li-ion battery while it also needs to connect to the EV charger.) Enable the communication between inverters in parallel. (If installing a slave inverter in a string of parallel inverters.)
2	RS485 (A1, B1) ⁽¹⁾ ⁽²⁾	<ul style="list-style-type: none"> Connect to the LG Chem Li-ion battery , to be used together with Enable signal Connect to the Sungrow AC011E-01 EV Charger (The default charger interface) Connect to an external device to receive the command to shut down the inverter remotely (Italy only) or enable the communication between inverters in parallel. (If installing a master inverter in a string of parallel inverters.)
3	BMS/CAN	To enable the communication between the inverter and the Li-ion battery
4	Enable	Connect to the LG Chem Li-ion battery , use with RS485 terminal
5	DI/DRM	<ul style="list-style-type: none"> "AU"/"NZ": Demand response enabling device (DRED) "IT": interface protection system (SPI) "DE": Ripple Control Receiver (RCR)
6	DO	<ul style="list-style-type: none"> Connect to an external light indicator and/or buzzer to signal an alarm. Connect to home load (such as SG Ready Heat Pump) for power management.

(1) When the inverter is connected to a third-party monitoring device, please confirm which communication interface is used, and whether it will cause loss of certain functions of the inverter.

(2) When RS485 (A1, B1) is used for parallel connection in the master inverter, the LG Chem battery (that uses RS485 for communication) cannot be used with the master inverter. It can still be used with the slave inverter.

6.3 Electrical Connection Overview

System Wiring Diagram

The electrical connection should be realized as follows:

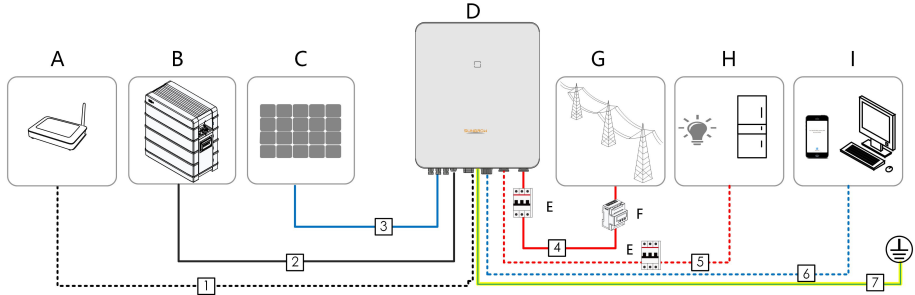

(A) Router	(B) Battery	(C) PV string
(D) Inverter	(E) AC circuit breaker	(F) Smart Energy Meter
(G) Grid	(H) Backup loads	(I) Monitoring device

WARNING
 Install an AC circuit breaker on the backup side. Otherwise, an electrical short circuit may occur, causing damage to the inverter.

NOTICE
 Ensure that AC output cables are firmly connected. Failing to do so may cause inverter malfunction or damage to its AC connectors.

NOTICE
 Make sure not to switch the phase order (L1-L3) which may cause malfunction.

table 6-3 Cable requirements

N-o.	Cable	Type	Specification	
			Outer diameter	Cross section
1	Ethernet cable	CAT 5E outdoor shielded network cable	5.3 ~ 7 mm	8 * 0.2 mm ²
2	Power Cable	Complying with 1,000V and 35A standard	5.5 ~ 8 mm	4 mm ²
		Complying with 1,000V and 40A standard		6 mm ²

N-o.	Cable	Type	Specification	
			Outer diameter	Cross section
3	DC cable	Outdoor multi-core copper wire cable Complying with 1,000V and 30A standard	6 ~ 9 mm	4 ~ 6 mm ²
4	AC cable *	Outdoor multi-core copper wire cable	14 ~ 25 mm	6 ~ 10 mm ²
5		Shielded twisted pair	12 ~ 14 mm	4 ~ 6 mm ²
6	Communication cable	CAT 5E outdoor shielded network cable	5.3 ~ 7 mm	2 * (0.5 ~ 1.0) mm ²
				8 * 0.2 mm ²
7	Additional Grounding cable *	Outdoor single-core copper wire cable	The same as that of the PE wire in the AC cable	

* If local regulations have other requirements for cables, set the cable specification according to the local regulations.

The factors that affect cable selection include rated current, cable type, routing mode, ambient temperature, and maximum expected line loss.

The cabling distance between the battery and the inverter should be less than 10 m, and within 5 m is recommended.

Backup Wiring Diagram(Australia and New Zealand)

The neutral cable of GRID side and BACK-UP side must be connected together according to the wiring rules AS/NZS_3000. Otherwise BACK-UP function will not work.

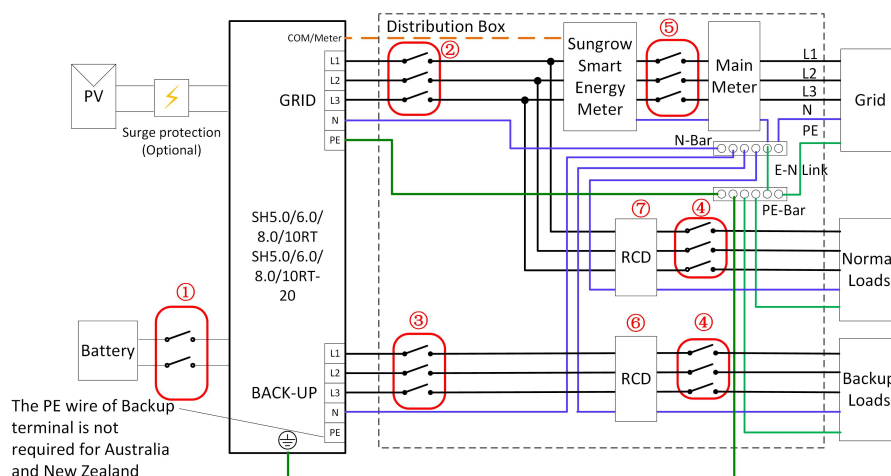

NO.	SH5.0/6.0RT/8.0/10RT	SH5.0/6.0RT/8.0/10RT-20
①	40A/600V DC breaker *	
②	32A/400V AC breaker	
③	25A/400V AC breaker	

NO.	SH5.0/6.0RT/8.0/10RT	SH5.0/6.0RT/8.0/10RT-20
④	Depends on loads	
⑤	Depends on household loads and inverter capacity	
⑥ ⑦	30mA RCD (Comply with local regulation)	

Note: * If the battery is integrated with a readily accessible internal DC breaker, no additional DC breaker is required.

Note: The values in the table are recommended values and can be set to other values according to actual conditions.

Backup Wiring Diagram (Other Countries)

The following diagram is an example for grid systems without special requirement on wiring connection.

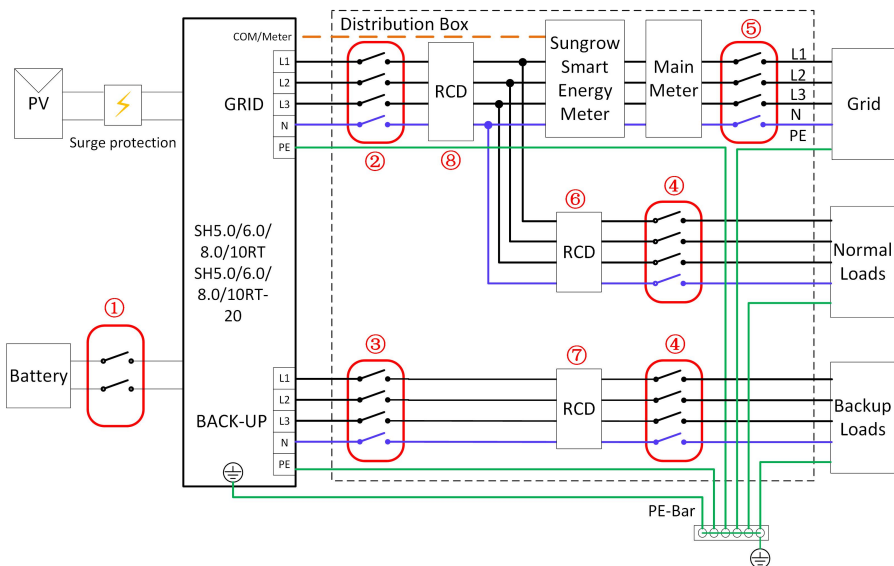

NO.	SH5.0/6.0RT/8.0/10RT	SH5.0/6.0RT/8.0/10RT-20
①	40A/600V DC breaker *	
②	32A/400V AC breaker	
③	25A/400V AC breaker	
④	Depends on loads	
⑤	Depends on household loads and inverter capacity (Optional)	
⑥ ⑦	30mA RCD (Recommended)	
⑧	300mA RCD (Recommended)	

Note: * If the battery is integrated with a readily accessible internal DC breaker, no additional DC breaker is required.

Note: The values in the table are recommended values and can be set to other values according to actual conditions.

Backup Wiring Diagram TT System

The following diagram is an example for grid systems without special requirement on wiring connection.

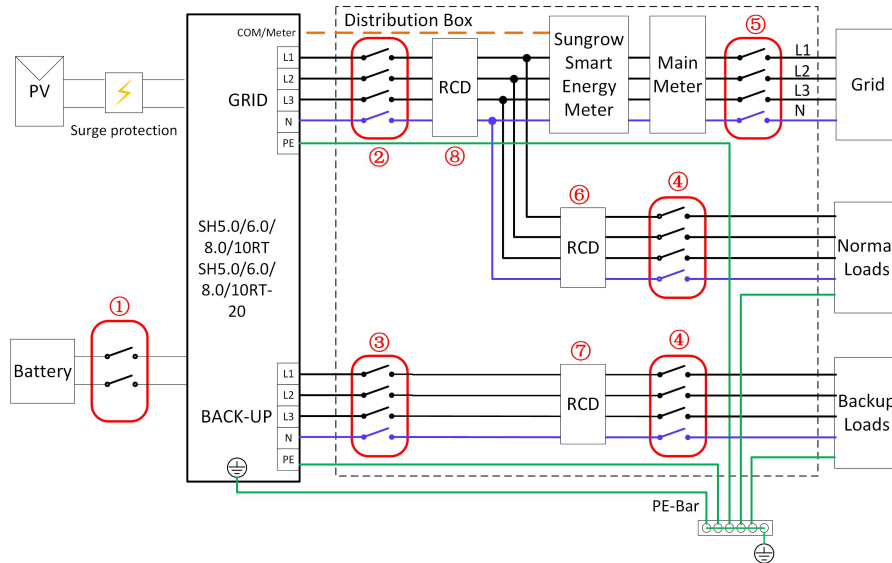

NO.	SH5.0/6.0RT/8.0/10RT	SH5.0/6.0RT/8.0/10RT-20
①	40A/600V DC breaker *	
②	32A/400V AC breaker	
③	25A/400V AC breaker	
④	Depends on loads	
⑤	Depends on household loads and inverter capacity	
⑥⑦	30mA RCD (Recommended)	
⑧	300mA RCD (Recommended)	

Note: * If the battery is integrated with a readily accessible internal DC breaker, no additional DC breaker is required.

Note: The values in the table are recommended values and can be set to other values according to actual conditions.

6.4 External Protective Grounding Connection

⚠ DANGER

Electric shock!

- **Make sure that the grounding cable is connected reliably. Otherwise, it may cause electric shock.**

⚠ WARNING

- **Since the inverter is not equipped with a transformer, neither the negative electrode nor the positive electrode of the PV string can be grounded. Otherwise, the inverter will not operate normally.**
- **Connect the grounding terminal to the external protective grounding point before AC cable connection, PV string connection, and communication cable connection.**
- **The external protective grounding point provides a reliable ground connection. Do not use an improper grounding conductor for grounding, Otherwise, it may cause product damage or personal injury.**
- **Depending on Local Rules, please also ground the PV panel subconstruction to the same common grounding point (PE Bar) in addition to local lightning protection rules.**

⚠ WARNING

The external protective grounding terminal must meet at least one of the following requirements.

- **The cross-sectional area of the grounding cable is not less than 10 mm² for copper wire or 16 mm² for aluminum wire. It is recommended that both the external protective grounding terminal and the AC side grounding terminal be reliably grounded.**
- **If the cross-sectional area of the grounding cable is less than 10 mm² for copper wire or 16 mm² for aluminum wire, ensure that both the external protective grounding terminal and the AC side grounding terminal are reliably grounded.**

The grounding connection can be made by other means if they are in accordance with the local standards and regulations, and SUNGROW shall not be held liable for the possible consequences.

6.4.1 External Protective Grounding Requirements

All non-current carrying metal parts and device enclosures in the PV power system should be grounded, for example, brackets of PV modules and inverter enclosure.

When there is only one inverter in the PV system, connect the external protective grounding cable to a nearby grounding point.

When there are multiple inverters in the PV system, connect the external protective grounding terminals of all inverters and the grounding points of the PV module brackets to ensure equipotential connections to ground cables (according to the onsite conditions).

6.4.2 Connection Procedure

There are two additional grounding terminals located at the bottom and right side of the inverter. Connect either one.

External grounding cable is prepared by customers.

step 1 Prepare the cable and OT/DT terminal.

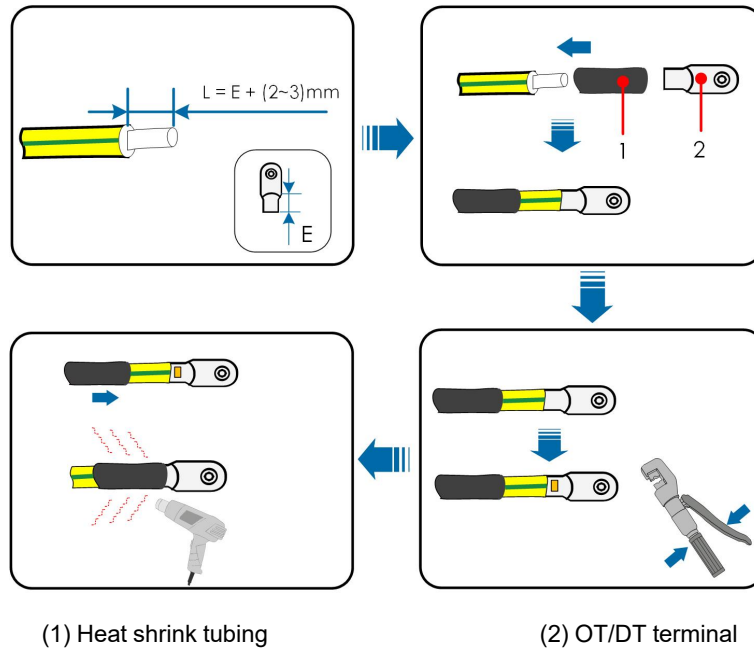

After being crimped, the OT terminal must wrap the wires completely, and the wires must contact the OT terminal closely.
When using a heat gun, protect the device from being scorched.

step 2 Remove the screw on the grounding terminal and fasten the cable with a screwdriver.

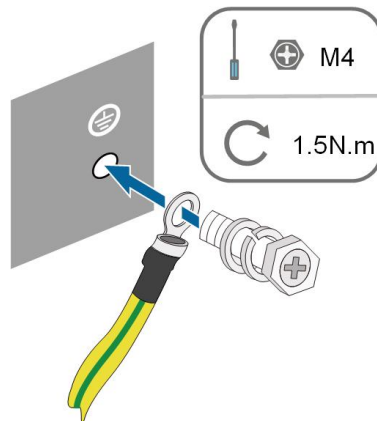

step 3 Apply paint to the grounding terminal to ensure corrosion resistance.

-- End

6.5 AC Cable Connection

6.5.1 AC Side Requirements



Only with the permission of the local grid department, the inverter can be connected to the grid.

Before connecting the inverter to the grid, ensure the grid voltage and frequency comply with requirements, for which, refer to "**Technical Data**". Otherwise, contact the electric power company for help.

AC Circuit Breaker

An independent three or four-pole circuit breaker must be installed on the output side of the inverter to ensure safe disconnection from the grid.

Inverter Model	Recommended Specification
SH5.0RT/SH5.0RT-20	25 A
SH6.0RT/SH6.0RT-20	
SH8.0RT/SH8.0RT-20	32 A
SH10RT/SH10RT-20	

WARNING

AC circuit breakers should be installed on the output side of the inverter and the grid side to ensure safe disconnection from the grid.

- **Determine whether an AC circuit breaker with greater overcurrent capacity is required based on actual conditions.**
- **Do not connect any local load between the inverter and the AC circuit breaker.**
- **Multiple inverters cannot share one AC circuit breaker.**

Residual Current Monitoring Device

With an integrated universal current-sensitive residual current monitoring unit included, the inverter will disconnect immediately from the mains power once a fault current with a value exceeding the limit is detected.

However if an external residual current device (RCD) is mandatory, the switch must be triggered at a residual current of 300 mA (recommended), or it can be set to other values according to local regulations. For example in Australia, the inverter can use an additional 30 mA(type A)RCD in installations.

6.5.2 Assembling the AC Connector

The AC terminal block is on the bottom side of the inverter. AC connection is the three-phase-four-wire grid + PE connection (L1, L2, L3, N, and PE).

step 1 Unscrew the swivel nut of the AC connector.

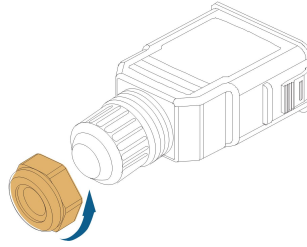

step 2 **(Optional)** Remove the inner sealing ring if the cable diameter is between 19 mm ~ 25 mm. Otherwise skip this step.

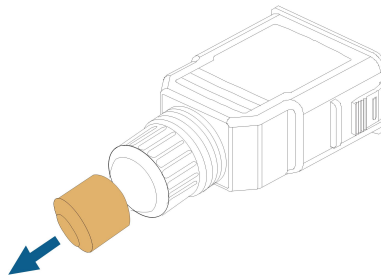

step 3 Take out the terminal plug from the housing.

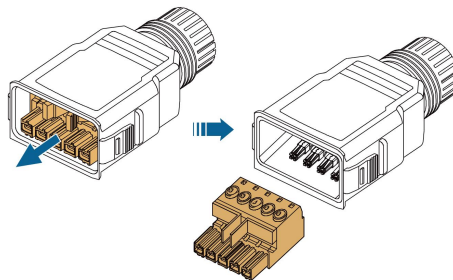

step 4 Thread the AC cable of appropriate length through the swivel nut and the housing.

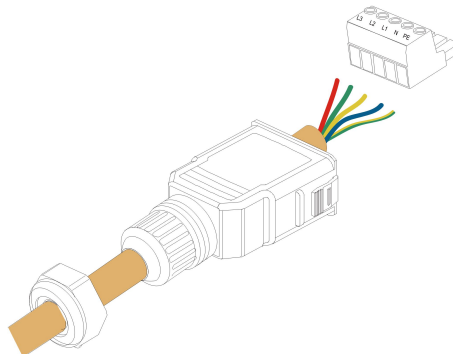

step 5 Strip 80 mm ~ 90 mm of the cable jacket and 12 mm of the wire insulation.

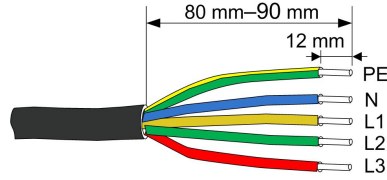

The color of the cable cores in the figure is for reference only, and cables or cable cores selected must meet local standards.

step 6 **(Optional)** When using a multi-core multi-strand copper wire cable, connect the AC wire head to the cord end terminal (hand-tight). In case of single-strand copper wire, skip this step.

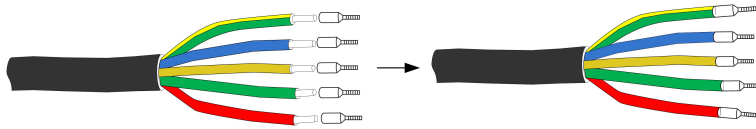

Select appropriate cord end terminal according to the cable cross-section area.

step 7 Fix all the wires to the terminal plug according to the assignment and tighten to a torque of 1.2 N•m–1.5 N•m with a screwdriver. Then push the terminal plug into the housing until there is an audible click.

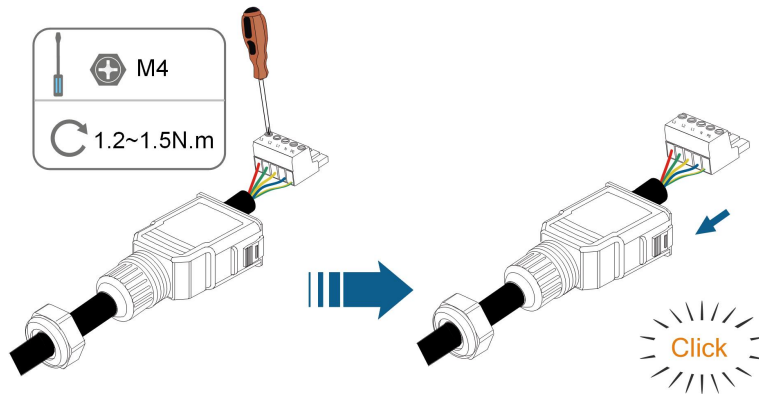

NOTICE

Observe the plug assignment. Do not connect any phase line to the "PE" terminal or the PE wire to the "N" terminal. Otherwise, unrecoverable damage to the inverter may follow.

step 8 Ensure that the wires are securely in place by slightly pulling them. Tighten the swivel nut to the housing.

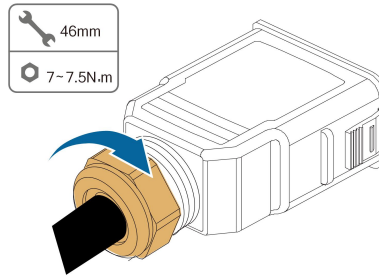

-- End

6.5.3 Installing the AC Connector

⚠ DANGER

High voltage may be present in inverter!

Ensure all cables are voltage-free before electrical connection.

Do not connect the AC circuit breaker until all inverter electrical connections are completed.

step 1 Disconnect the AC circuit breaker and secure it against reconnection.

step 2 Remove the waterproof lid from the **GRID** terminal.

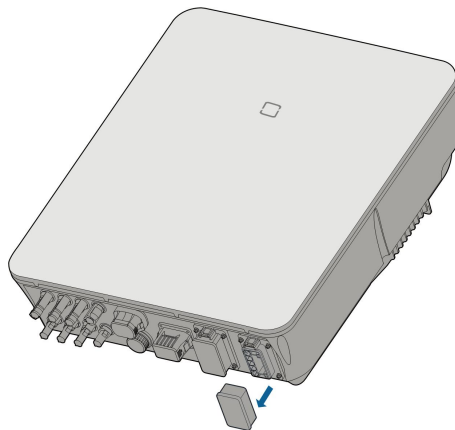

step 3 Insert the AC connector into the **GRID** terminal on the bottom of the inverter until there is an audible sound.

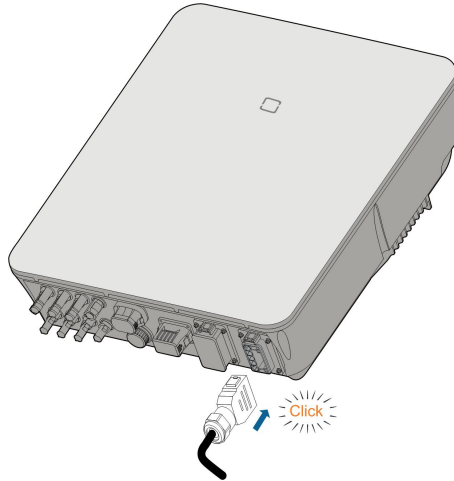

step 4 **(Optional)** Insert the block into AC connector, as shown in the figure below.

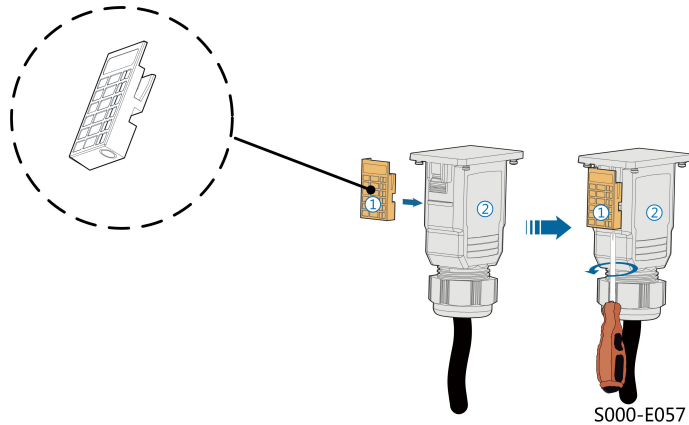

- 1 Insert block ① into AC connector ② from the side.
- 2 Tighten the screw on the bottom of block ①.

step 5 Connect PE cable to ground.

step 6 Connect phase cable and “N” cable to AC circuit breaker.

step 7 Connect AC circuit breaker to utility grid.

step 8 Make sure all AC cables are firmly installed via the right torque tool or dragging the cables slightly.

-- End

6.6 DC Cable Connection

⚠ DANGER

The PV string will generate lethal high voltage when exposed to sunlight.

- **Respect all safety instructions listed in relevant documents about PV strings.**

⚠ WARNING

- **Make sure the PV array is well insulated to ground before connecting it to the inverter.**
- **Make sure the maximum DC voltage and the maximum short circuit current of any string never exceed inverter permitted values specified in "Technical Data".**
- **Check the positive and negative polarity of the PV strings, and connect the PV connectors to corresponding terminals only after ensuring polarity correctness.**
- **During the installation and operation of the inverter, please ensure that the positive or negative electrodes of PV strings do not short-circuit to the ground. Otherwise, an AC or DC short-circuit may occur, resulting in equipment damage. The damage caused by this is not covered by the warranty.**
- **Electric arc or contactor over-temperature may occur if the DC connectors are not firmly in place, and the loss caused is not covered by the warranty.**
- **If the DC input cables are reversely connected or the positive and negative terminals of different MPPT are shorted to ground at the same time, while the DC switch is in the "ON" position, do not operate immediately. Otherwise, the inverter may be damaged. Please turn the DC switch to "OFF" and remove the DC connector to adjust the polarity of the strings when the string current is lower than 0.5 A.**
- **Use the DC connectors supplied with the product for DC cable connection. Using incompatible DC connectors may result in serious consequences, and the device damage is not covered under warranty.**
- **Inverters do not support full parallel connection of strings (Full parallel connection refers to a connection method in that strings are connected in parallel and then connected to the inverter separately).**
- **Do not connect one PV string to multiple inverters. Otherwise, the inverters may be damaged.**

⚠ WARNING

Before connecting the PV array to the inverter, ensure that the impedances between the positive terminals of the PV string and earth, and between the negative terminals of the PV string and earth are larger than 1 M Ohm.

NOTICE

The following requirements about PV string connection must be met. Otherwise, it may cause irreversible damage to the inverter, which is not covered by the warranty.

- **Mixed use of PV modules of different brands or models in one MPPT circuit, or PV modules of different orientation or inclination in a string may not damage inverter, but will cause system bad performance!**

NOTICE

Note the following items when laying out cables on site:

- **The axial tension on PV connectors must not exceed 80 N. Avoid axial cable stress on the connector for a long time during field wiring.**
- **Radial stress or torque must not be generated on PV connectors. It may cause the connector waterproof failure and reduce connector reliability.**
- **Leave at least 50 mm of slack to avoid the external force generated by the cable bending affecting the waterproof performance.**
- **Refer to the specifications provided by the cable manufacturer for the minimum cable bending radius. If the required bending radius is less than 50 mm, reserve a bending radius of 50 mm. If the required bending radius is greater than 50 mm, reserve the required minimum bending radius during wiring.**

6.6.1 PV Input Configuration

In Australia and New Zealand, ensure the DC power for any PV string never exceeds a certain level with regards to the string voltage to avoid derating:

≤ 12.5 kW if string voltage is lower than 500 V

≤ 10 kW if string voltage is between 500 V and 800 V

≤ 8 kW if string voltage is between 800 V and 1000 V

For SH5.0/6.0/8.0RT/SH5.0–8.0RT-20, each PV input operates independently and has its own MPPT. In this way, string structures of each PV input may differ from each other, including PV module type, number of PV modules in each string, angle of tilt, and installation orientation.

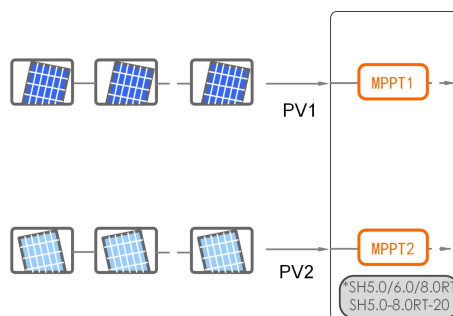

For SH10RT/SH10RT-20, each pair of PV terminals is corresponding to an independent PV string. PV input PV1 connect to MPPT1 and PV2, PV3 connect to MPPT2. For the best use of PV power, PV2 and PV3 should be the same in PV string structure, including the type, number, tilt, and orientation of the PV modules.

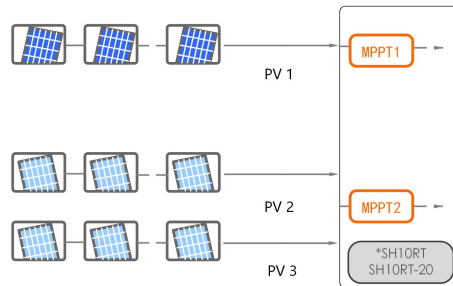

For SH10RT/SH10RT-20, if two PV strings are paralleled externally, the paralleled strings can be connected to PV2 or PV3 only, and the other one cannot be used to connect other PV strings.

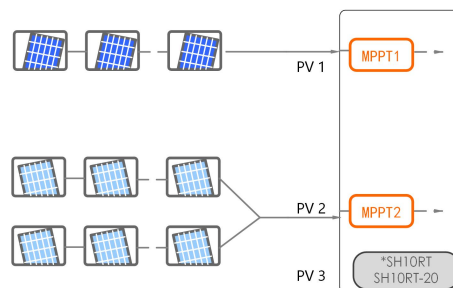

Prior to connecting the inverter to PV inputs, the following electrical specifications must be met simultaneously:

Model	Open-circuit Voltage Limit	Max. current for Input Connector
SH5.0RT/SH5.0RT-20	1000 V	30 A
SH6.0RT/SH6.0RT-20		
SH8.0RT/SH8.0RT-20		
SH10RT/SH10RT-20		

6.6.2 Assembling the PV Connectors

⚠ DANGER

High voltage may be present in the inverter!

- Ensure all cables are voltage-free before performing electrical operations.
- Do not connect the DC switch and AC circuit breaker before finishing electrical connection.



To ensure IP65 protection, use only the supplied connector.

step 1 Strip the insulation from each DC cable by 7 mm–8 mm.

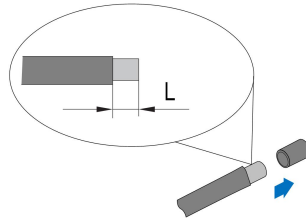

step 2 Assemble the cable ends with the crimping pliers.

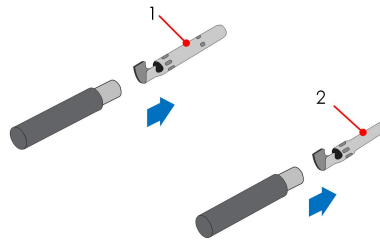

1: Positive crimp contact

2: Negative crimp contact

step 3 Lead the cable through cable gland, and insert the crimp contact into the insulator until it snaps into place. Gently pull the cable backward to ensure firm connection. Tighten the cable gland and the insulator (torque 2.5 N.m to 3 N.m).



step 4 Check for polarity correctness.

NOTICE

If the PV polarity is reversed, the inverter will be in a fault or alarm state and will not operate normally.

-- End

6.6.3 Installing PV Connector

step 1 Rotate the DC switch to "OFF" position.

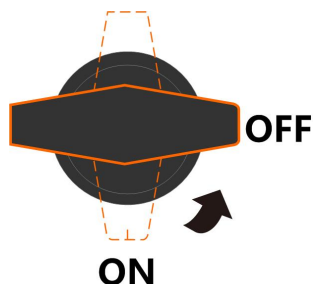

step 2 Check the cable connection of the PV string for polarity correctness and ensure that the open circuit voltage in any case does not exceed the inverter input limit of 1,000V.

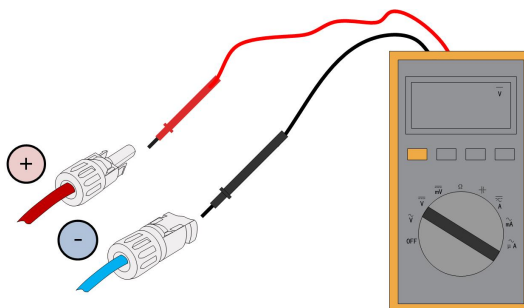

NOTICE

The multimeter must have a DC voltage range of at least 1,000 V. If the voltage is a negative value, the DC input polarity is incorrect. Please correct the DC input polarity. If the voltage is greater than 1,000 V, too many PV modules are configured to the same string. Please remove some PV modules.

step 3 Connect the PV connectors to corresponding terminals until there is an audible click.

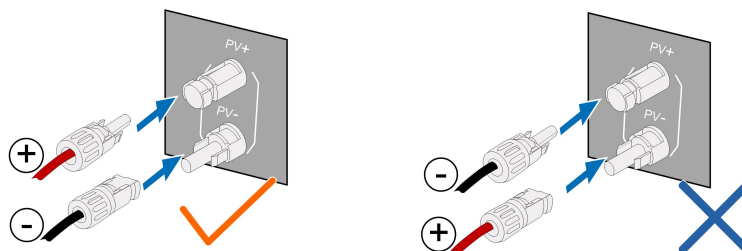

step 4 Follow the foregoing steps to connect PV connectors of other PV strings.

step 5 Seal any unused PV terminal with a terminal cap.

SUNGROW inverters cannot be used with third-party optimizers.

If the PV string is equipped with the optimizer, please refer to the optimizer manual for electrical connections and make sure that the polarity of the optimizer cables is correct.

-- End

6.7 Communication Connection

LAN function

- Through the Modbus TCP/IP protocol, the EMS or the Logger from the third party can fully control the on/off, derating, charging and discharging of the inverter.

WLAN function

With the WiNet-S module installed, view corresponding information through iSolarCloud App or iSolarCloud Web.

RS485 function

The RS485 communication interfaces are used to establish communication connection with monitoring devices.

6.7.1 Ethernet Connection

6.7.1.1 Assembling the LAN Connector



Skip step 1 if the standard network cable with RJ45 plug is prepared.

- step 1 **(Optional)** Strip the insulation layer of the communication cable with an Ethernet wire stripper, and lead the corresponding signal cables out. Insert the stripped communication cable into the RJ45 plug in the correct order, and crimp it with a crimper.

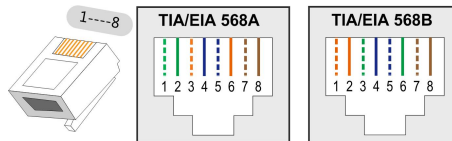

- step 2 Unscrew the swivel nut from the connector.

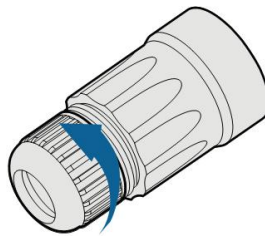

- step 3 Remove the inner rubber gasket.

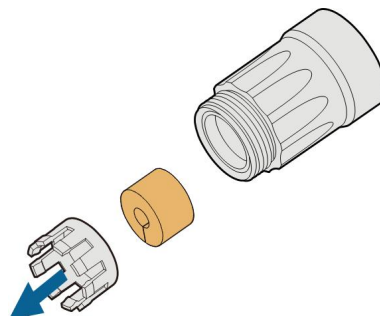

step 4 Insert the RJ45 plug into the front plug connector until there is an audible click, and install the rubber gasket.

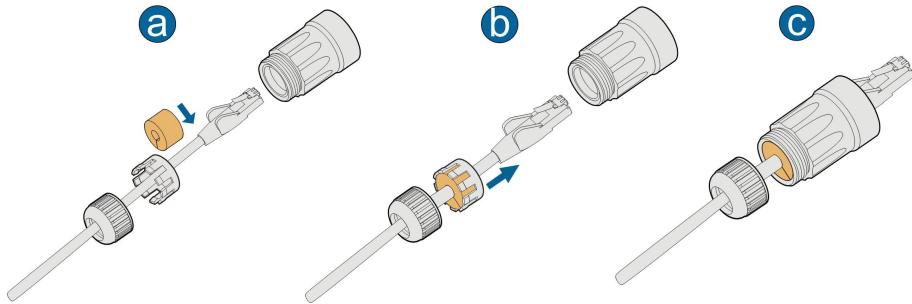

-- End

6.7.1.2 Installing the LAN Connector

step 1 Unscrew the waterproof lid from the **LAN** terminal.

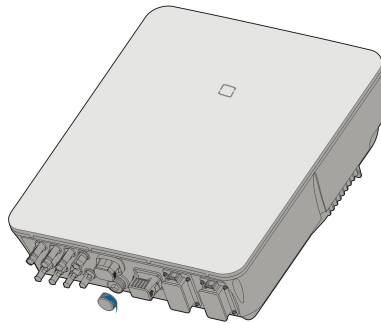

step 2 Insert the LAN connector into **LAN** terminal on the bottom of the inverter.

step 3 Pull cables outwards to confirm whether they are fastened firmly, then tighten the swivel nut with appropriate torque.

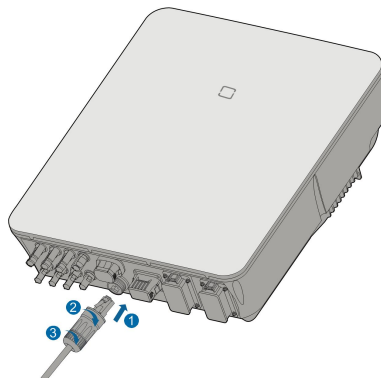

-- End

6.7.2 WiNet-S Connection

The WiNet-S module supports Ethernet communication and WLAN communication. It is not recommended to use both communication methods at the same time.

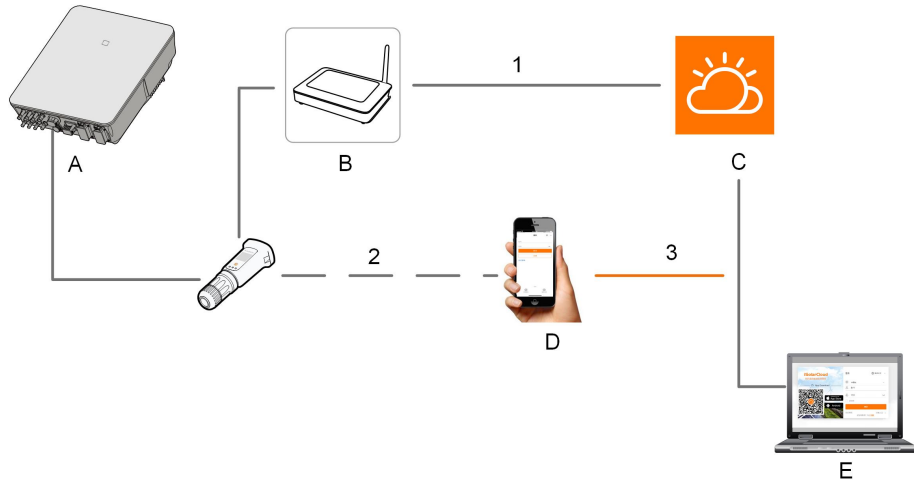

(A) Inverter

(B) Router/Switch

(C) iSolarCloud server

(D) iSolarCloud App

(E) iSolarCloud

(1) ——— Internet

(2) - - - - Local access

(3) ——— Remote

For details, see the quick guide for the WiNet-S module. Scan the following QR code for the quick guide.



6.7.2.1 Ethernet Communication

step 1 **(Optional)** Strip the insulation layer of the communication cable with an Ethernet wire stripper, and lead the corresponding signal cables out. Insert the stripped communication cable into the RJ45 plug in the correct order, and crimp it with a crimper.

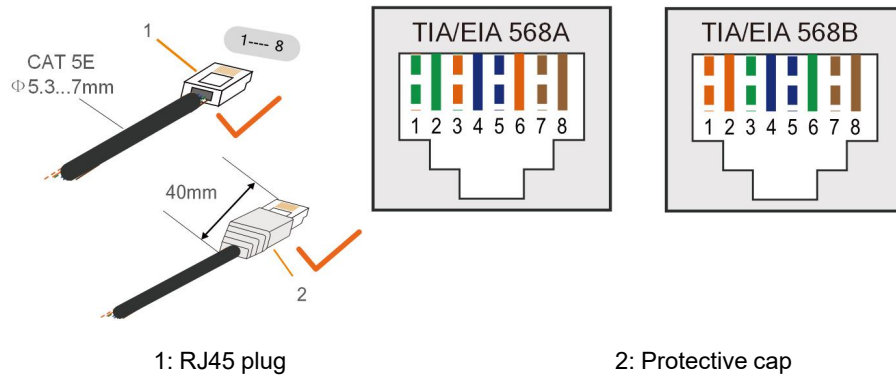

Skip this step if a standard network cable with RJ45 plug is prepared.

step 2 Unscrew the swivel nut from the communication module and take out the inner sealing ring.

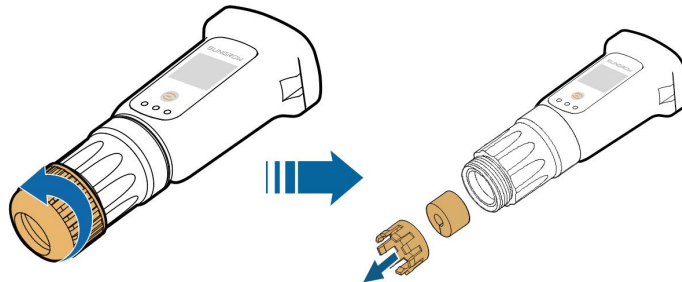

step 3 Unscrew the housing from the communication module.

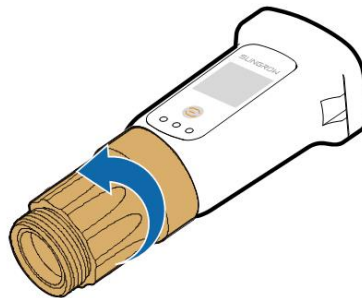

step 4 Thread the network cable through the swivel nut and gasket. Afterwards, route the cable into the opening of the sealing. Finally, insert the cable through the housing.

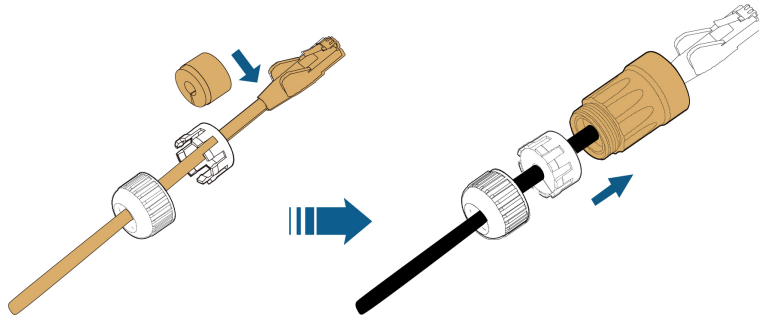

step 5 Insert the RJ45 plug into the front plug connector until there is an audible click and tighten the housing. Install the gasket and fasten the swivel nut.

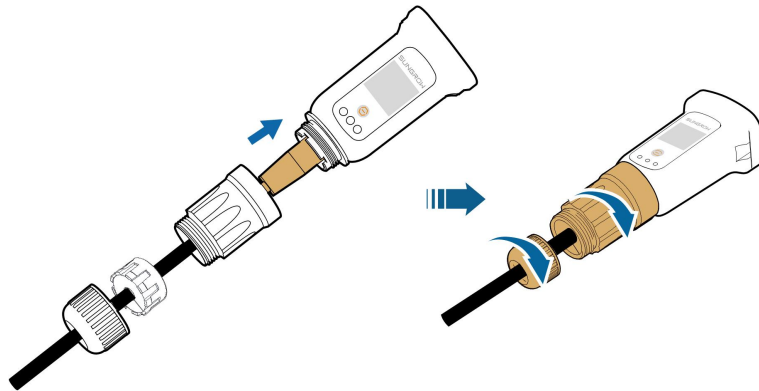

step 6 Remove the waterproof lid from the **WLAN** terminal and install WiNet-S.

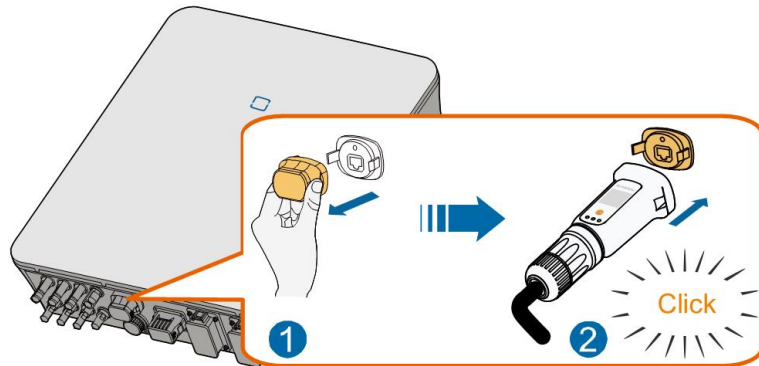

step 7 Slightly shake it by hand to determine whether it is installed firmly.

-- End

6.7.2.2 WLAN Communication

step 1 Remove the waterproof lid from the **WLAN** terminal.

step 2 Install the module. Slightly shake it by hand to determine whether it is installed firmly, as shown below.

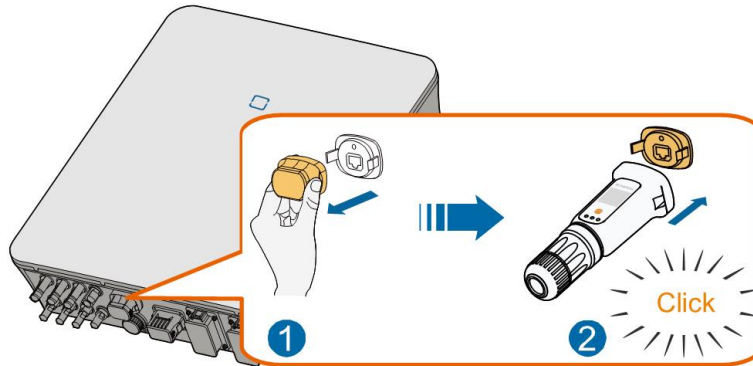

step 3 Refer to the guide delivered with the module for the set-up.

-- End

6.7.3 RS485 Connection

Where there is only one inverter, the RS485 can be connected to an external device for the communication.

Where there are two or more inverters in parallel, the RS485 connection enables the communication between master inverter and slave inverter, as shown in the following figure.

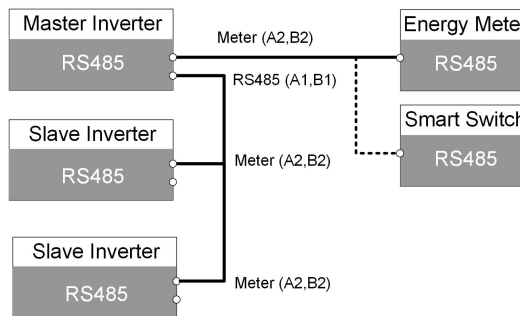

6.7.3.1 Assembling the COM Connector

step 1 Unscrew the swivel nut from the connector.

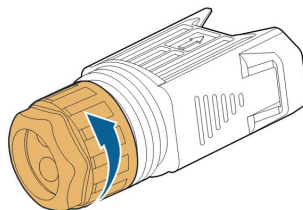

step 2 Take out the terminal block.

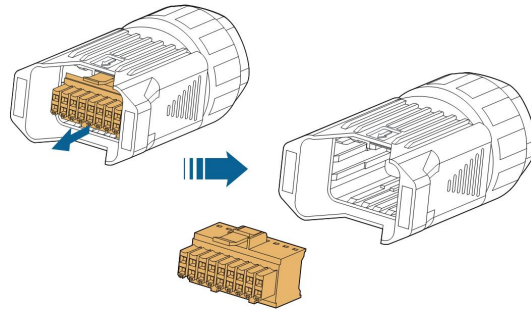

step 3 Remove the seal and lead the cable through the cable gland.

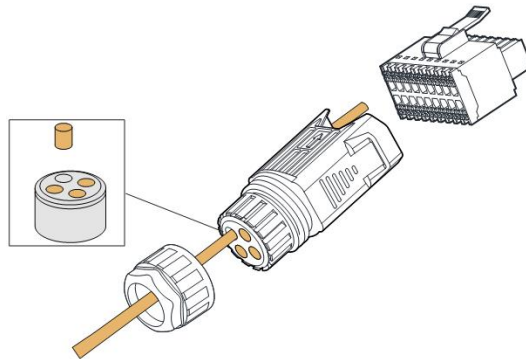

step 4 Remove the cable jacket and strip the wire insulation.

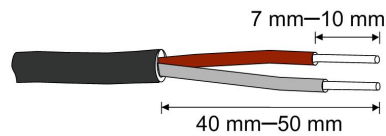

step 5 Plug the wires into the **RS485** terminal according the labels on the bottom of the inverter.

For example for connecting the energy meter, connect the RS485 cables to A2,B2.

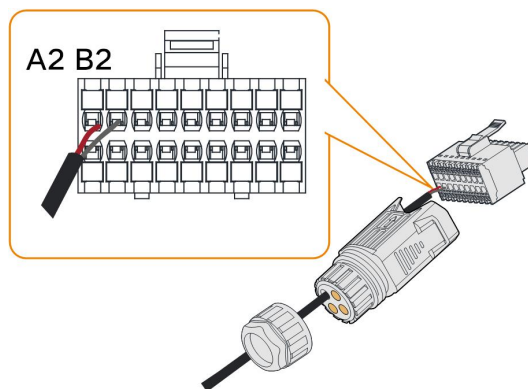

step 6 Pull the wires outward to check whether they are firmly installed.

step 7 Insert the terminal block into the connector until it snaps into place with an audible click.

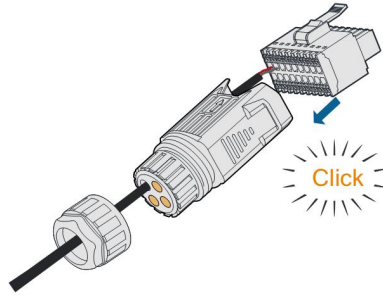

step 8 Fasten the swivel nut.

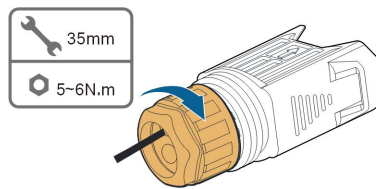

-- End

6.7.3.2 Installing the COM Connector

step 1 Remove the waterproof lid from the **COM** terminal.

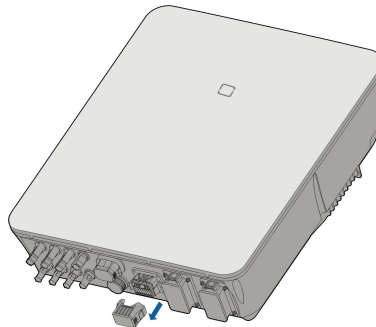

step 2 Insert the COM connector into **COM** terminal on the bottom of the inverter until there is an audible click.



-- End

6.8 Smart Energy Meter Connection

The inverter is equipped with the feed-in power limit function, so as to meet the requirements of some national standards or grid standards for the output power at the grid connection point. The export control functionality has not been tested to AS/NZS 4777.2:2020. For the setting of feed-in power limit, refer to the section "[8.5.1 Feed-in Limitation](#)".

Contact SUNGROW to ensure that the Smart Energy Meter model is available locally.



This section mainly describes the cable connections on the inverter side. Refer to the quick guide delivered with the Smart Energy Meter for the connections on the meter side.

The energy meter is mainly used to detect the direction and magnitude of the current. And the energy meter data may not be used for billing purposes.

Procedure

For detailed connection description of the Smart Energy Meter cable, refer to the section "[6.7.3 RS485 Connection](#)".

- If the Smart Energy Meter DTSU666 is used (provided in the box), please connect Pin 24 on the meter to Pin A2 on the inverter and Pin 25 on the meter to Pin B2 on the inverter.

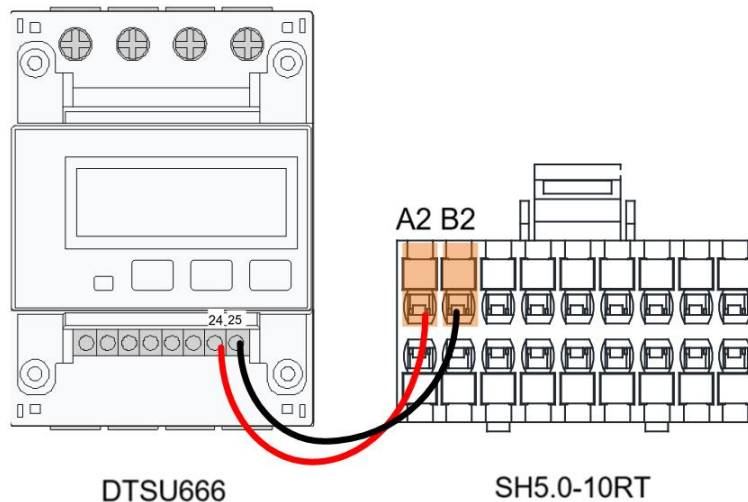

- For SH5.0–10RT-20, please connect Pin A on the smart energy meter DTSU666–20 to Pin A2 on the inverter and Pin B on the meter to Pin B2 on the inverter.

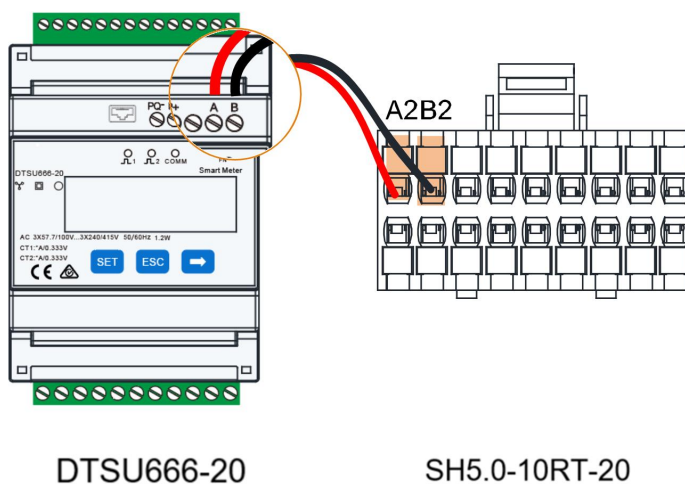

For more information on meters, including CT installation, consult the DTSU666-20 quick installation guide support.sungrowpower.com. Before installing, please carefully check the contents of the meter manual.

- If electricity meters of other brands are used, please refer to the corresponding electric meter manual.

6.9 Battery Connection

This section mainly describes the cable connections on the inverter side. Refer to the instructions supplied by the battery manufacturer for the connections on the battery side and configuration.

WARNING

Only use properly insulated tools to prevent accidental electric shock or short circuits. If insulated tools are not available, use electrical tape to cover the entire exposed metal surfaces of the available tools except their tips.

WARNING

The plug connector must be connected only by trained electricians.

WARNING

Do not disconnect under load!
Battery connectors must not be disconnected while under load. They can be placed in a no load state by shutting down the inverter completely.

⚠ WARNING

During the installation and operation of the inverter, please ensure that the positive or negative polarities of batteries do not short-circuit to the ground. Otherwise, an AC or DC short-circuit may occur, resulting in equipment damage. The damage caused by this is not covered by the warranty.

If the hybrid inverter is not connected to a battery, it will not support reliably the backup function.



The battery should be connected to the common grounding of the house (PE Bar) rather than directly to the inverter PE.

The energy in the battery will not backfeed into the PV modules.

6.9.1 Connecting the Power Cable

⚠ WARNING

Do not connect loads between the inverter and the battery. The battery cables should be connected correctly. That is, the positive and negative terminals of the battery connect to the positive and negative terminals on the inverter respectively. Otherwise, the inverter may be damaged, or even a fire could happen.

All power cables are equipped with water-proof direct plug-in connectors, which match the battery terminals at the bottom of the inverter.



The Sungrow SBR batteries are equipped with a DC circuit breaker, If there is no DC circuit breaker inside the battery, install an external DC circuit breaker between the inverter and the battery to ensure that the inverter can be safely disconnected from the battery. Ensure that cables are correctly connected between the external DC circuit breaker and the battery, and between the external DC circuit breaker and the inverter.

6.9.1.1 Assembling the SUNCLIX Connector

NOTICE

During assembly, be careful not to contaminate, pull out, or shift, the seal in the cable gland. A contaminated or shifted seal impairs strain relief and leak tightness.

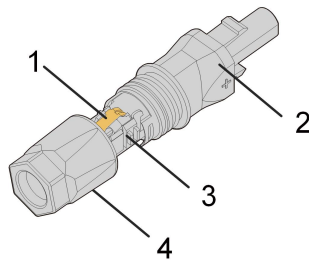

figure 6-2 SUNCLIX Connector Components

1: Spring

2: Sleeve

3: Insert

4: Cable gland

step 1 Strip the insulation from the cable by 15 mm.

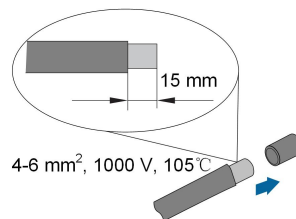

step 2 Pry the connection open and pull the sleeve and the insert apart.

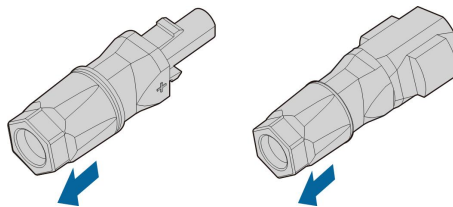

step 3 Insert the stripped cable into the cable gland up to the stop. The stranded wire can be seen inside the spring. Press the spring down until it audibly snaps into place.

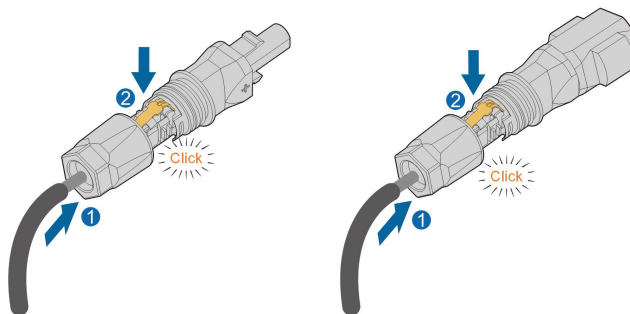

step 4 Push the insert into the sleeve and tighten the cable gland (torque 2 N·m).

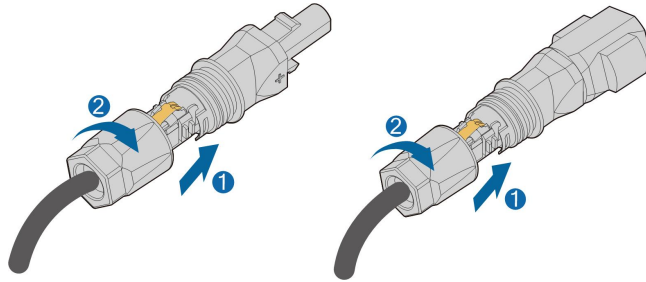

-- End

6.9.1.2 Installing the SUNCLIX Connector

NOTICE

Only connect these connectors with other SUNCLIX connectors. When making the connections, always observe the specifications regarding nominal voltage and nominal current. The smallest common value is permissible.

step 1 Plug the connectors into **BAT+** and **BAT-** terminals.

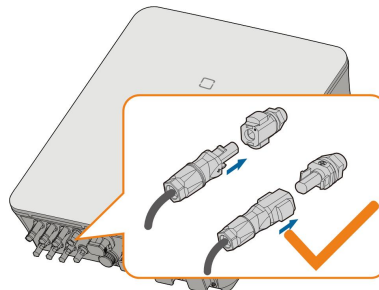

step 2 Ensure that the connectors are securely in place.

-- End

6.9.1.3 Assembling Evo2 Compatible Connector



The connector type is subject to the actual received device.

step 1 Strip 15 mm of the insulation layer from each PV cable.

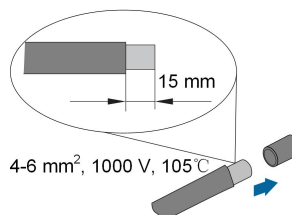

step 2 Unscrew the swivel nut of the connector.

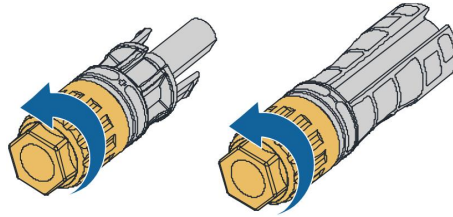

step 3 Lead the stripped cable through the swivel nut and insert it into the insulation sleeve till the end.

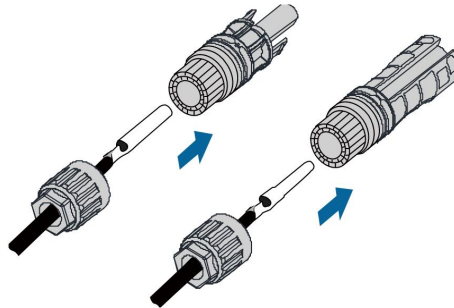

step 4 Screw the swivel nut of the connector and gently pull the cable backward to ensure a firm connection.

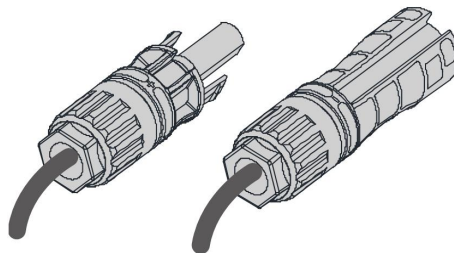

-- End

6.9.1.4 Installing Evo2 Compatible Connector

step 1 Insert the connector into the **BAT+** and **BAT-** terminals.

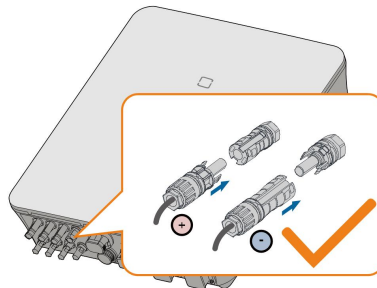

step 2 Check for polarity correctness.

-- End

6.9.2 Connecting the CAN Cable

The CAN cable enables the communication between the inverter and the Li-ion battery from SUNGROW, BYD and Pylontech.

Procedure

For detailed connection description of the CAN cable, refer to the section "[6.7.3 RS485 Connection](#)". Connect CAN High on the battery side to pin5 CANH on the hybrid inverter and CAN Low on Battery side to pin7 CANL on the hybrid inverter.

6.9.3 Connecting the Enable Cable

The Enable cable along with the RS485 cable, are used for communication between the inverter and the Li-ion battery from LG Chem.

Procedure

For detailed connection description of the Enable cable, refer to the section "[6.7.3 RS485 Connection](#)". Plug the wires into the **Enable** terminal according the labels on the bottom of the inverter.

6.10 EV-Charger Communication Connection

The electrical connection of the Sungrow AC011E-01 EV charger can be referred to the EV-Charger manual.

The inverter communicates with the EV charger through the RS485 communication interface.

Procedure

The EV charger has two RS485 communication ports, Port A and Port B. The communication cables shall be connected to corresponding ports. It is recommended to connect the Port A and Port B of the EV charger to Port A1 and Port B1 of the inverter by communication cables.

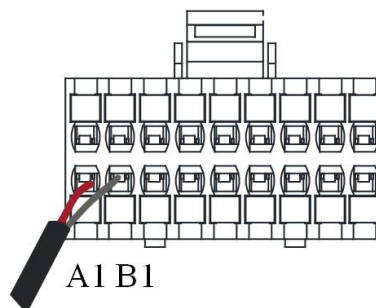

Connect either the LG lithium battery or the EV-Charger to A1 and B1.

6.11 DO Connection

The inverter has one DO relay with multiple functions as follows:

- Consumer load control. In this case the DO relay will control a contactor that will open or close in certain condition. Please choose the appropriate contactor according to the load power, e.g. the contactor types of the 3TF30 series from SIEMENS (3TF30 01- 0X).
- Earth fault alarm. In this case, the additional equipment required is a light indicator and/or a buzzer.

Relay	Trigger condition	Description
Consumer load control	The load control mode has been set via the iSolarCloud App.	The relay is activated once the conditions of the control mode are satisfied. See "8.12.10 Load Control" .
Earth fault alarm	The earth fault occurs.	Once the inverter receives the earth fault signal, the relay closes the contact. The relay remains triggered until the fault is removed. See "8.12.13 Grounding Detection" .

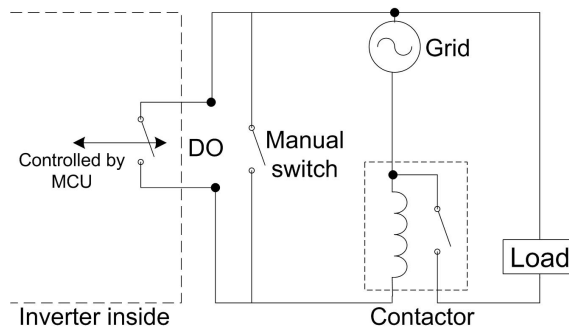

NOTICE

- **A DC signal of max 30V/3A or an AC contactor must be installed between the inverter and appliances. It is forbidden to connect the load directly to the DO port.**
- **The current of the DO dry contact should not be larger than 3 A.**
- **The DO node is not controlled once the inverter is powered off. Connect the AC contactor by the manual switch, so as to control the loads.**

Procedure

For detailed connection description of the DO cable, refer to the section ["6.7.3 RS485 Connection"](#). Plug the wires into the **DO** terminal according the labels on the bottom of the inverter.

6.12 DI Connection

DRM and Ripple Control support only one function at the same time.

DRM

The inverter supports the demand response modes as specified in the standard AS/NZS 4777. The inverter has integrated a terminal block for connecting to a DRED.

After the connection, the DRED assert DRMs by shorting together terminals as specified in the table below.

table 6-4 Method of Asserting DRMs

Mode	Asserted by Shorting Terminals
DRM0	R & C
DRM1	D1/5 & C
DRM2	D2/6 & C
DRM3	D3/7 & C
DRM4	D4/8 & C
DRM5	D1/5 & R
DRM6	D2/6 & R
DRM7	D3/7 & R
DRM8	D4/8 & R

The modes from DRM0 to DRM8 are supported by the inverter and the information is marked on the label located in the top of COM terminal.

Wiring between the inverter and the DRED is as follows.

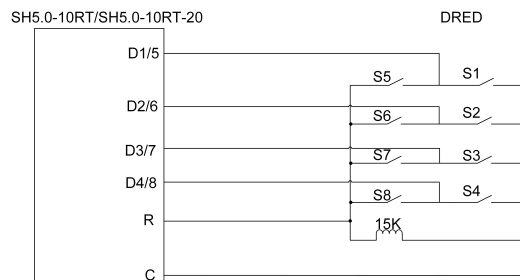

The switches that need to be closed in the state of DRM0 ~ DRM8 are shown in the table below.

Demand Response Mode	Operational Instruction	Switch state
DRM0	O10	Close S1 and S5
DRM1	O11	Close S1
DRM2	O12	Close S2
DRM3	O13	Close S3
DRM4	O14	Close S4
DRM5	O15	Close S5
DRM6	O16	Close S6

Demand Response Mode	Operational Instruction	Switch state
DRM7	OI7	Close S7
DRM8	OI8	Close S8

Ripple Control

In Germany, the grid company uses the Ripple Control Receiver to convert the grid dispatching signal and send it as a dry contact signal.

Wiring of the ripple control receiver dry contact cables is shown in the figure below:

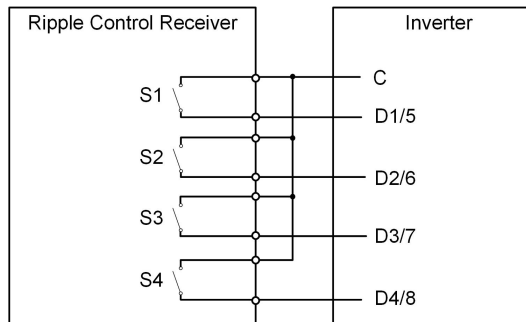
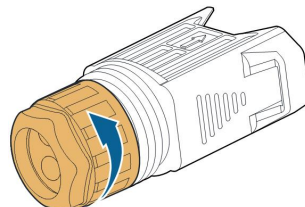

table 6-5 Method of Asserting DI Mode

S-1	S2	S3	S4	Switch Operation on External RCR	Output power (in % of the Rated AC output power)
0	0	0	0	None	100 % (configurable according to need)
1	0	0	0	Close S1	100 %
0	1	0	0	Close S2	60 %
0	0	1	0	Close S3	30 %
1	1	0	0	Close S1 and S2	0 % (disconnect from grid)

6.12.1 Assembling the COM Connector

step 1 Unscrew the swivel nut from the connector.



step 2 Take out the terminal block.

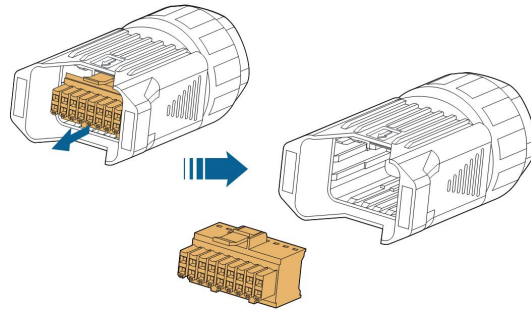

step 3 Remove the seal and lead the cable through the cable gland.

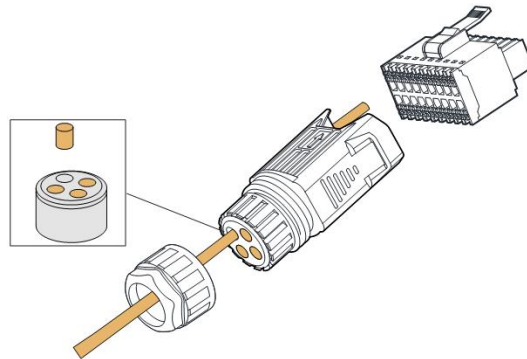

step 4 Remove the cable jacket by 7 mm–10 mm.

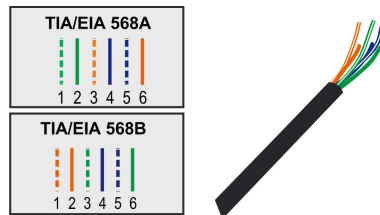

step 5 Plug the wires into the corresponding terminal according to the labels on the bottom of the inverter.

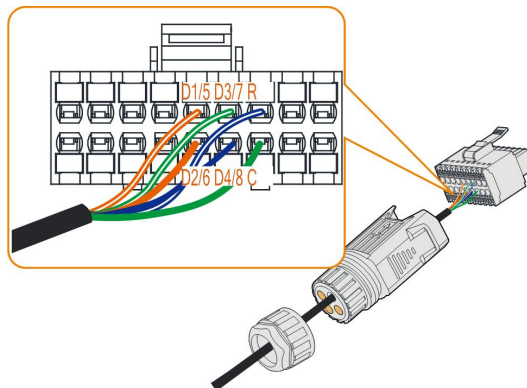

step 6 Pull the wires outward to check whether they are firmly installed.

step 7 Insert the terminal block into the connector until it snaps into place with an audible click.

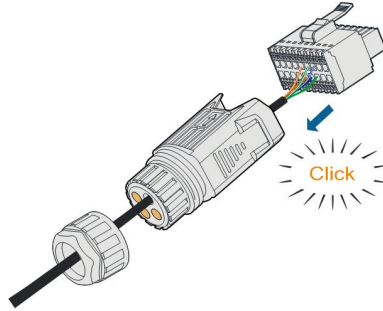

step 8 Fasten the swivel nut.

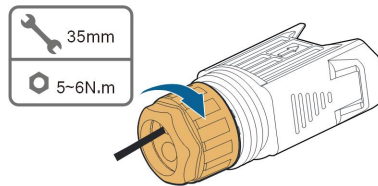

-- End

6.12.2 Installing the COM Connector

step 1 Remove the waterproof lid from the **COM** terminal.

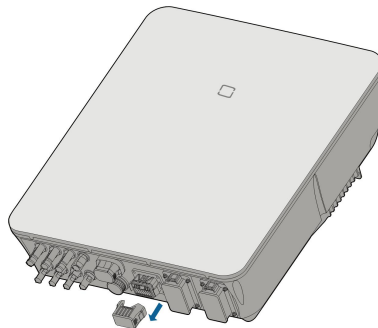

step 2 Insert the COM connector into **COM** terminal on the bottom of the inverter until there is an audible click.

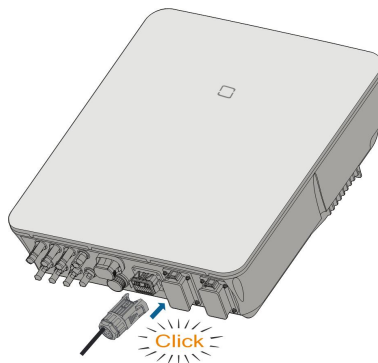

step 3 Pull cables outwards to confirm whether they are fastened firmly.

step 4 Connect the other end to the DRED / Ripple Control Receiver device.

-- End

6.13 Backup Connection

step 1 Assembling the BACK-UP Connector. Specifically, refer to "6.5.2 Assembling the AC Connector".



The PE wire of Backup terminal is not required for Australia and New Zealand.

step 2 Remove the waterproof lid from the **BACK-UP** terminal.

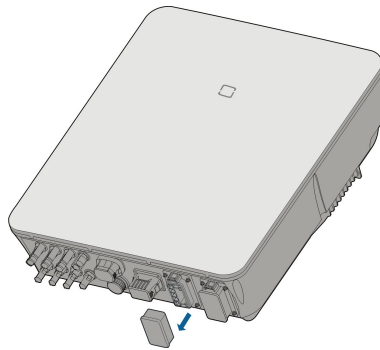

step 3 Align the Backup connector and the **BACK-UP** terminal and mate them together by hand until a "Click" is heard or felt.

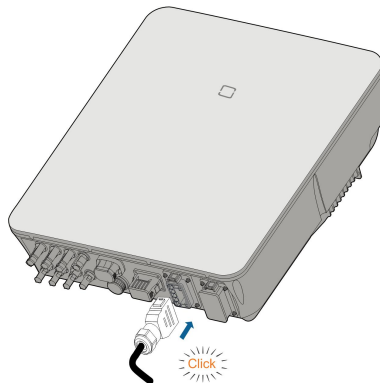

step 4 Pull all the lines outward to check whether they are firmly installed.

-- End

7 Commissioning

7.1 Inspection Before Commissioning

Check the following items before starting the inverter:

- All equipment has been reliably installed.
- DC switch(es) and AC circuit breaker are in the "OFF" position.
- The ground cable is properly and reliably connected.
- The AC cable is properly and reliably connected.
- The DC cable is properly and reliably connected.
- The communication cable is properly and reliably connected.
- The vacant terminals are sealed.
- No foreign items, such as tools, are left on the top of the machine or in the junction box (if there is).
- The AC circuit breaker is selected in accordance with the requirements of this manual and local standards.
- All warning signs & labels are intact and legible.

7.2 Commissioning Procedure

If all of the items mentioned above meet the requirements, proceed as follows to start up the inverter for the first time.

- step 1 Connect the AC circuit breaker.
- step 2 **(Optional)** Connect the external DC circuit breaker between the inverter and the battery pack if a battery is equipped.
- step 3 **(Optional)** Power on the battery pack manually if a battery is equipped.
- step 4 Rotate the DC switch to "ON". The DC switch may be integrated in the inverter or installed by the customer, wait for at least 5 minutes.
- step 5 If the irradiation and grid conditions meet requirements, the inverter will normally operate. The connection time for inverter to grid may take some minutes or even to more according to different country code chosen in the initial settings and the real site grid condition.
- step 6 Observe the LED indicator to ensure that the inverter operates normally. (Refer to "[2.4 LED Indicator](#)").

-- End



- Strictly follow the preceding sequence. Otherwise, the product may be damaged, and the loss caused is not covered by the warranty.
- Before closing the AC circuit breaker between the inverter and the power grid, use a multimeter that is set to the AC gear to ensure that the AC voltage is within the specified range. Otherwise, the inverter may be damaged.

7.3 App Preparation

step 1 Install the iSolarCloud App with latest version. Refer to "8.2 Installing App".

step 2 Register an account. Refer to "8.3 Account Registration". If you have got the account and password from the distributor/installer or SUNGROW, skip this step.

step 3 Download the firmware package to the mobile device in advance. Refer to "Firmware Update". This is to avoid download failure due to poor on-site network signal.

-- End

7.4 Creating a Plant

Prerequisites:

- The account and password for logging in to iSolarCloud App have been obtained from the distributor/installer or SUNGROW.
- The communication device is normally connected to the inverter.
- System positioning is enabled and iSolarCloud App is allowed to access location information.

step 1 Open the App, tap  in the upper right corner of the interface, and select the correct access address.

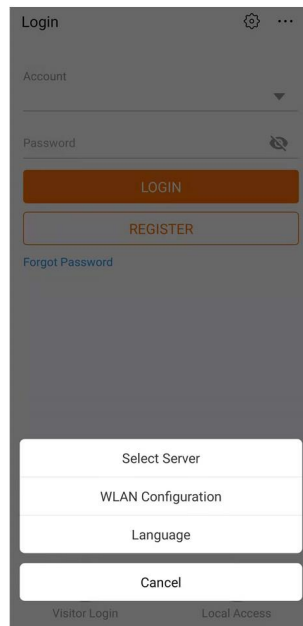

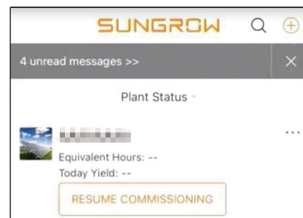

figure 7-1 Select Access Address

step 2 Enter the account and password on the login interface, and tap **LOGIN** to log in.

step 3 Tap  in the upper right corner to enter the plant creation interface.



step 4 Fill in the content according to actual needs, and the parameters containing * are required. Tap **Next** to enter the next interface.

figure 7-2 Plant Creation Settings

Parameter Name	Description
Plant name	The name of the plant.
Plant type	The type of the plant, which should be set corresponding to the actual plant type.
Installed power	The installed power of the plant.
Country/Region	The country/region where the plant is located.
Time zone	The time zone where the plant is located, which can be filled through automatic positioning and manual input.
Plant address	<p>The location of the plant, which can be filled in two ways:</p> <ul style="list-style-type: none"> Manually: Manually enter the plant location in the input box. Automatically: Tap  to automatically obtain the current location or search for the location of the plant, and then tap Confirm.

Parameter Name	Description
Grid-connection type	The way the plant is connected to the grid, including 100% Feed-in, Self-Consumption, Zero Export, and Off-grid.
Grid-connected date	The time when the plant is connected to the grid.
Owner's email address	Fill in the owner information of the plant, and both registered and un-registered email addresses are supported.
Postal code	The postal code of the place where the plant is located.
Plant image	Take photos of the plant and upload them.
Feed-in tariff	<p>The feed-in tariff can be set in two ways:</p> <ul style="list-style-type: none"> • Enter the feed-in tariff directly in the input box. • Tap More Configurations, select the tariff unit, enter the feed-in tariff, and tap Confirm. Enable Time-of-Use Tariff if needed. Tap Add Time-of-Use Tariff, add time intervals and price, and tap Confirm. Please note that if Time-of-use Tariff is enabled, the time periods shall cover 24 hours a day, and can not overlap.
Consumption tariff	<p>Set the consumption tariff as follows:</p> <ul style="list-style-type: none"> • Tap More Configurations, select the tariff unit, enter the consumption tariff, and tap Confirm. Enable Time-of-Use Tariff if needed, and refer to the setting methods of the feed-in tariff.

- step 5 Bind a device through scanning the QR code on the device, manually inputting the device S/N, or uploading a QR code picture. Tap **Confirm** after the QR code is identified or the S/N is verified.

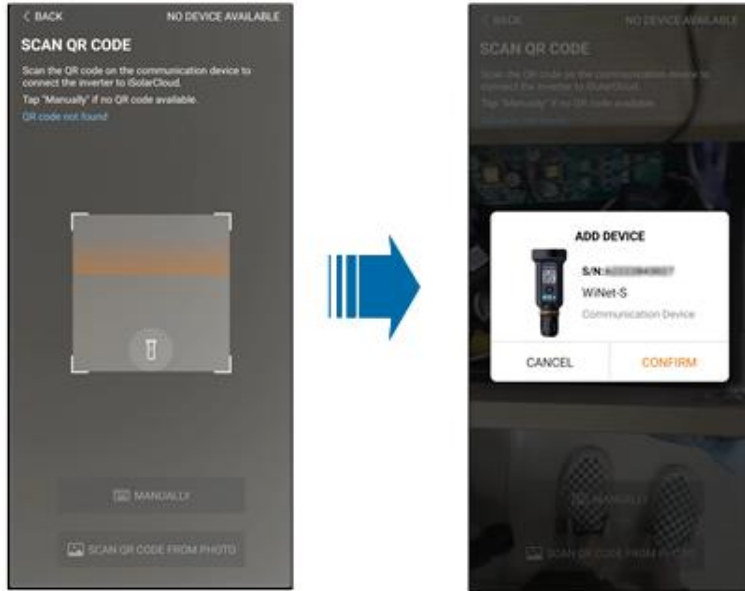

step 6 After a device is bound, tap **Device** and **Commissioning** to go to corresponding interface.

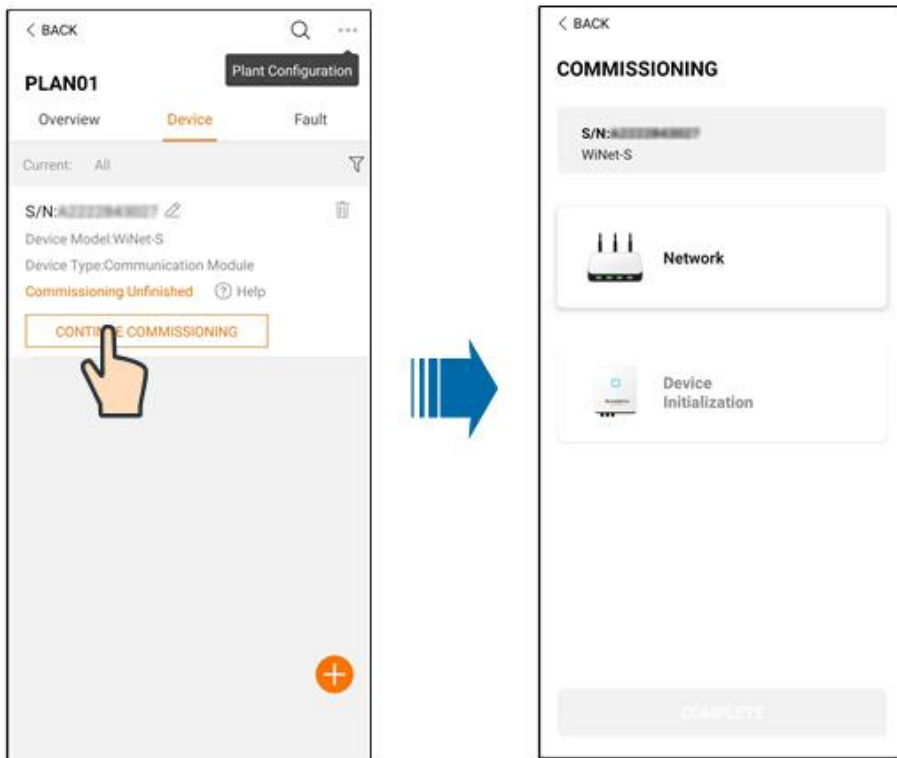

step 7 Tap **Network Configuration** to go to the **WLAN connection** interface. Tap the home network in the WLAN list, enter the password, and then tap **Confirm**.

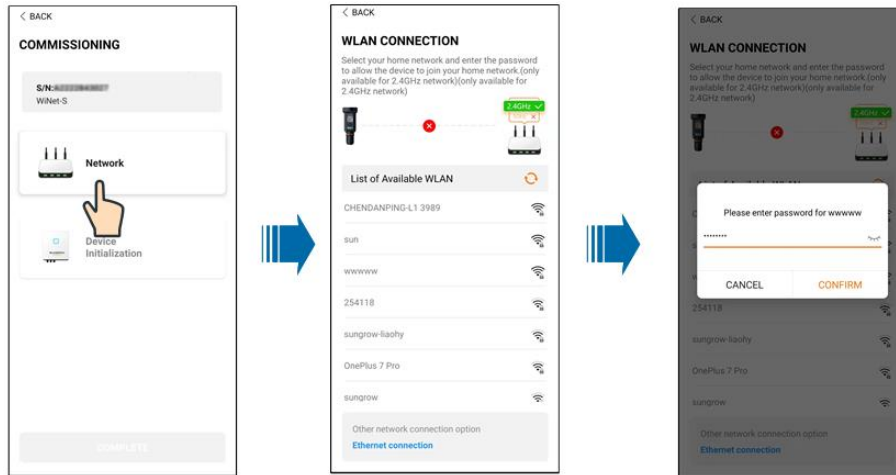

- step 8 Enter the **Activate EasyConnect** interface, and press the multi-function button on the WiNet-S to enable the Easyconnect mode according to the prompt on the screen. The App automatically enters a waiting processing interface if this mode is enabled, and automatically returns to the commissioning interface after the processing is completed.

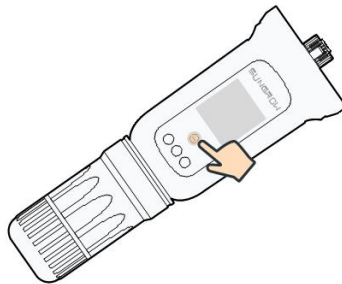

NOTICE

Only the 2.4 GHz working band is supported under the networking mode.
If the Easyconnect fails, please refer to other methods in the WiNet-S manual to establish the connection.

- step 9 Tap **Device Initialization** to go to the **Device initialization** interface. Set the initialization protection parameters as needed and tap **Settings** to return to the commissioning interface.

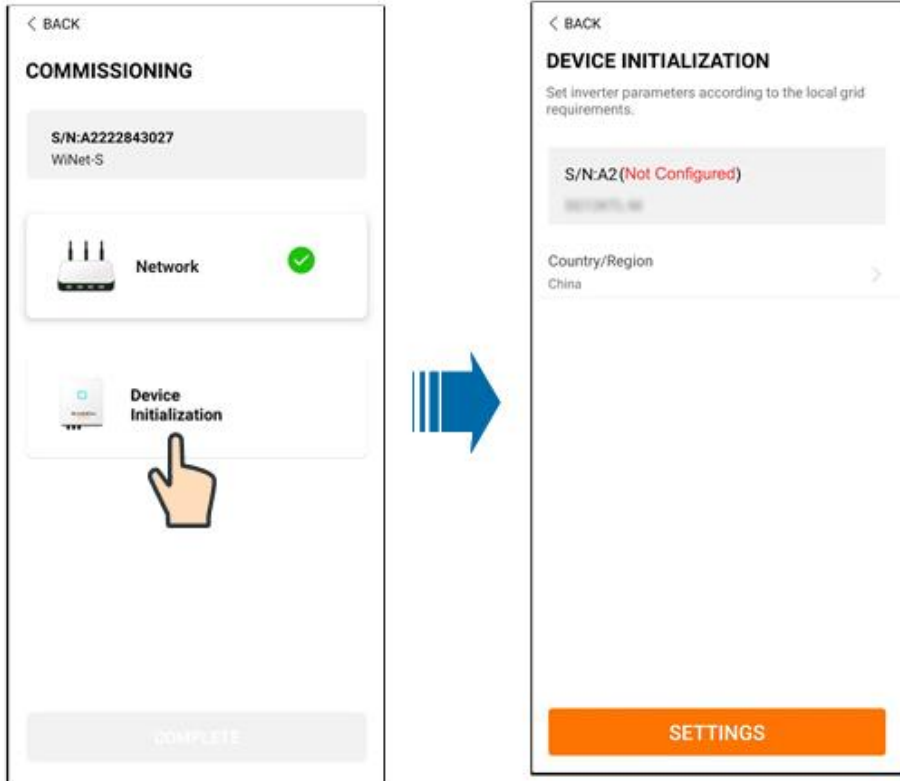

When the country is set to Australia, additionally set the applicable network service provider and then the grid type.

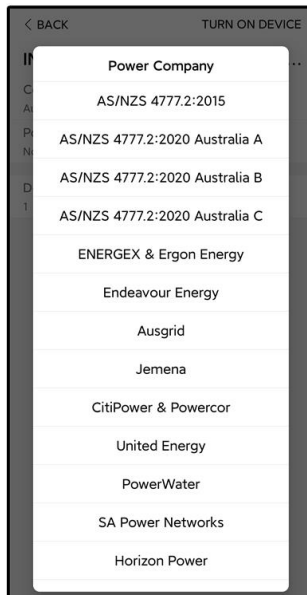

The image shown here is for reference only. Refer to the actual interface for the supported network service providers.

table 7-1 Description of Network Service Provider and Grid Type

Network Service Provider	Grid Type
AS/NZS 4777.2:2015	/
AS/NZS 4777.2:2020	/
Australia A	/
AS/NZS 4777.2:2020	/
Australia B	/
AS/NZS 4777.2:2020	/
Australia C	/
ENERGEX & Ergon Energy	<ul style="list-style-type: none"> • STNW1170: single-phase < 10 kVA & three-phase < 30 kVA • STNW1174: 30 kVA < $P_n \leq 1500$ kVA
Jemena	<ul style="list-style-type: none"> • ≤ 10 kVA per phase (or 30 kVA per three phase) • ELE GU 0014: 30 kVA–200 kVA
Endeavour Energy	MDI 0043
Ausgrid	NS194
CitiPower & Powercor	<ul style="list-style-type: none"> • ≤ 5 kVA for single-phase & 30 kVA for three-phase • > 30 kVA three-phase
United Energy	<ul style="list-style-type: none"> • UE-ST-2008.1: ≤ 10 kVA for single-phase & 30 kVA for three-phase • UE-ST-2008.2: > 30 kVA three-phase
PowerWater	Embedded Generation Notice Photovoltaic Systems:2020
SA Power Networks	<ul style="list-style-type: none"> • TS129-2019: < 10 kW for single-phase & 30 kW for three-phase • TS130-2017: > 30 kW & ≤ 200 kW • TS131-2018: > 200 kW
Horizon Power	<ul style="list-style-type: none"> • HPC-9DJ-13-0001-2019: ≤ 10kVA for single-phase & 30 kVA for three-phase • HPC-9DJ-13-0002-2019: > 30kVA & ≤ 1MVA
westernpower	EDM#33612889-2019
AusNet Services	Basic Micro Embedded Generation: 2020

* For compliance with AS/NZS 4777.2:2020, please select from Australia A/B/C. Please contact your electricity grid operator for which region to use.



- Please check the country supported by this product at [http:// support.sungrow-power.com/](http://support.sungrow-power.com/).
- Set **Country/Region** to the country/region where the inverter is installed. Otherwise, the inverter may report a fault.

step 10 After a plant is successfully created, return to the App home page to view the plant information.

-- End

8 iSolarCloud App

8.1 Brief Introduction

The iSolarCloud App can establish communication connection to the inverter via the WLAN, providing remote monitoring, data logging and near-end maintenance on the inverter. Users can also view inverter information and set parameters through the App.

* To achieve direct login via WLAN, the wireless communication module developed and manufactured by SUNGROW is required. The iSolarCloud App can also establish communication connection to the inverter via Ethernet connection.



- This manual describes only how to achieve near-end maintenance via WLAN direct connection.
- Screenshots in this manual are based on the V2.1.6 App for Android system, and the actual interfaces may differ.

8.2 Installing App

Method 1

Download and install the App through the following application stores:

- MyApp (Android, mainland China users)
- Google Play (Android, users other than mainland China ones)
- App Store (iOS)

Method 2

Scan the following QR code to download and install the App according to the prompt information.



The App icon appears on the home screen after installation.



8.3 Account Registration

The account distinguishes two user groups, end user and distributor/installer.

- The end user can view plant information, create plants, set parameters, share plants, etc.
- The distributor/installer can help the end user to create plants, manage, install, or maintain plants, and manage users and organizations.

step 1 Tap **REGISTER** to enter the registration screen.

USER REGISTRATION

Account Type

Please select the relevant server for your area; if not available, please select the international station

Distributor/Installer

Distributor/Installer is the person who install or/and manage the plant, and supply service to end user

End User

End User is the person who will own or has owned one inverter or more

step 2 Select the relevant server for your area.

step 3 Select **End user** or **Distributor/Installer** to enter the corresponding screen.

The screenshot shows a mobile application interface for registering a distributor or installer. At the top left is a back arrow and the word 'BACK'. The title is 'Distributor/Installer'. Below the title are several input fields:

- '* Contact Phone Number' with a dropdown menu showing '+86' and a 'Please Enter' prompt.
- A blue link 'Send Verification Code'.
- '* Verification Code' with a 'Please Enter' prompt and a 'Help' icon.
- 'Username' with a 'Please Enter' prompt and an information icon.
- '* Password' with a 'Please Enter' prompt.
- '* Confirm Password' with a 'Please Enter' prompt.
- '* Country/Region' with a 'Please Select' prompt and a right arrow.
- 'Company Name'.

 At the bottom left is a checkbox labeled 'Accept Privacy Policy'. At the bottom center is a grey 'REGISTER' button.

step 4 Fill in the registration information, including email, verification code, password and affirmation and country (region). The distributor/installer has the permission to fill in the company name and the code of upper level installer/distributor.



The code of upper level distributor/installer can be obtained from the upper level distributor/installer. Only when your organization belongs to the upper level distributor/installer organization, can you fill in the corresponding code.

step 5 Tick **Accept privacy protocol** and tap **Register** to finish the registration operation.

-- End

8.4 Login

8.4.1 Requirements

The following requirements should be met:

- The AC and DC sides or the AC side of the inverter is powered-on.
- The WLAN function of the mobile phone is enabled.
- The mobile phone is within the coverage of the wireless network produced by the communication module.

8.4.2 Login Procedure

step 1 For the WiNet-S module, press the multi-function button 3 times to enable the WLAN hot-spot. No password is required and the valid time is 30 minutes.

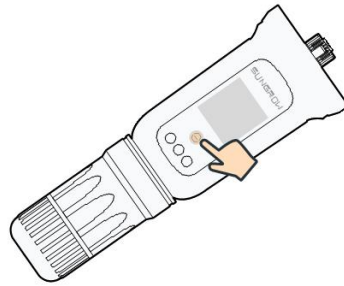

figure 8-1 Enabling the WLAN Hotspot

- step 2 Connect the mobile phone to the WLAN network named as "SG-xxxxxxxxxx" (xxxxxxxxxx is the serial number indicated on the side of the communication module).
- step 3 Open the App to enter the login screen. Tap **Local Access** to enter the next screen.
- step 4 Tap **Confirm**, then enter the password and tap **LOGIN**. Or tap **MANUAL CONNECTION** at the bottom of the interface and select **WiNet-S**, then enter the password and tap **LOGIN**.



- If the WiFi signal, serial number or inverter related data information cannot be found, unplug and reinsert the Winet-S or press the multi-function button of the Winet-S three times.
- The default account is "user" and the initial password is "pw1111" which should be changed for the consideration of account security. Tap "More" at the lower right corner on home page and choose "Change Password".

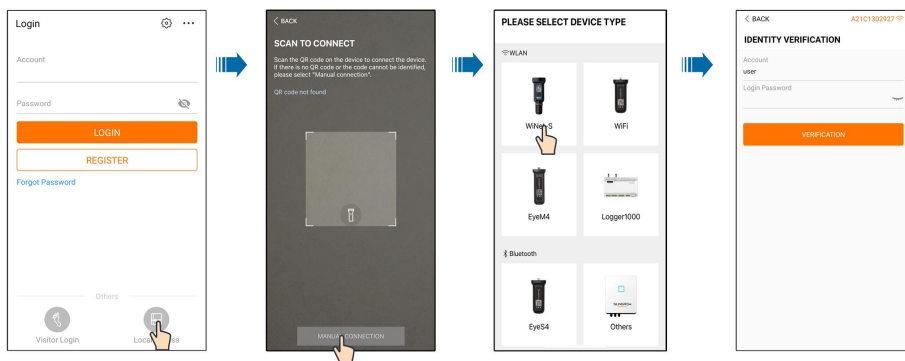

figure 8-2 WLAN Local Access

- step 5 If the inverter is not initialized, navigate to the quick setting screen to initialize the protection parameters. For details, please refer to "**Initial Settings**".

NOTICE

The "Country/Region" must be set to the country where the inverter is installed at. Otherwise, the inverter may report errors.

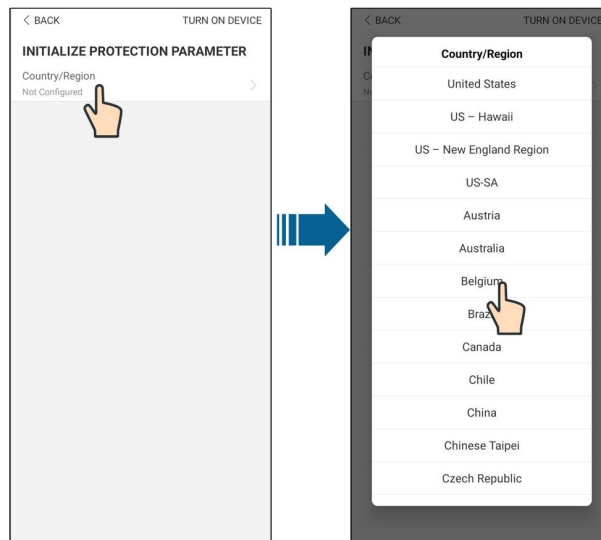

figure 8-3 WLAN Local Access

step 6 After finishing the settings, tap **TUNR ON DEVICE** at the upper right corner and the device will be initialized. The App will send start instructions and the device will start and operate.

step 7 After initialization settings, the App will return automatically to the home page.

-- End

8.5 Initial Settings

8.5.1 Feed-in Limitation

The function of the feed-in limitation is to control the amount of power injected in the grid by the plant. In some situations , this function is also called as **Export limitation** or **Zero export**. The feed-in limitation function requires the using of Smart Energy Meter. Without the Smart Energy Meter, the feed-in limitation function will be unavailable.

8.5.2 Backup Mode

The backup mode is off by default, the user can set an amount of **Reserved Battery SOC for Off-Grid**. It is the minimum battery level in the on-grid state and will be supplied to the Backup loads in case of grid blackout.

8.5.3 Reactive Power Regulation Mode

The inverter provides a reactive power regulation function. Use the **Reactive Power Regulation Mode** parameter to activate this function and select proper regulation mode.

table 8-1 Descriptions of reactive power regulation mode:

Mode	Descriptions
Off	The PF is fixed at +1.000.
PF	The reactive power can be regulated by the parameter PF (Power Factor).
Qt	The reactive power can be regulated by the parameter Q-Var limits (in %).
Q(P)	The PF changes with the output power of the inverter.
Q(U)	The reactive power changes with the grid voltage.

“Off” Mode

The reactive power regulation function is disabled. The PF is limited to +1.000.

“PF” Mode

The power factor is fixed and reactive power setpoint is calculated according to the current power. The PF ranges from 0.8 leading to 0.8 lagging.

Leading: the inverter is sourcing reactive power to the grid.

Lagging: the inverter is injecting reactive power into the grid.

“Qt” Mode

In the Qt mode, system rated reactive power is fixed, and the system injects reactive power according to the delivered reactive power ratio. The **Reactive Power Ratio** is set through the App.

The setting range of the reactive power ratio is 0~100% or 0~-100%, corresponding to the ranges of inductive and capacitive reactive power regulation respectively.

“Q(P)” Mode

The PF of the inverter output varies in response to the output power of the inverter.

table 8-2 “Q(P)” Mode Parameter Descriptions:

Parameter	Explanation	Default		Range
		DE	AU	
Q(P) Curve	Select corresponding curve according to local regulations	A		A, B, C*
QP_P1	Output power at P1 on the Q(P) mode curve (in percentage)	20%	25%	0% ~ 100%
QP_P2	Output power at P2 on the Q(P) mode curve (in percentage)	50%		20% ~ 100%
QP_P3	Output power at P3 on the Q(P) mode curve (in percentage)	100%		20% ~ 100%
QP_K1	Power factor at P1 on the Q(P) mode curve	1		Curve A/C: 0.8 ~ 1
QP_K2	Power factor at P2 on the Q(P) mode curve	1		
QP_K3	Power factor at P3 on the Q(P) mode curve	0.95	0.90	Curve B: - 0.6 ~ 0.6

Parameter	Explanation	Default		Range
		DE	AU	
QP_EnterVoltage	Voltage percentage for Q(P) function activation	105%		100% ~ 110%
QP_ExitVoltage	Voltage percentage for Q(P) function deactivation	100%		90% ~ 100%
QP_ExitPower	Power percentage for Q(P) function deactivation	20%		1% ~ 100%
QP_EnableMode	Unconditional activation/deactivation of Q(P) function	Yes		Yes / No

* Curve C is reserved and consistent with Curve A currently.

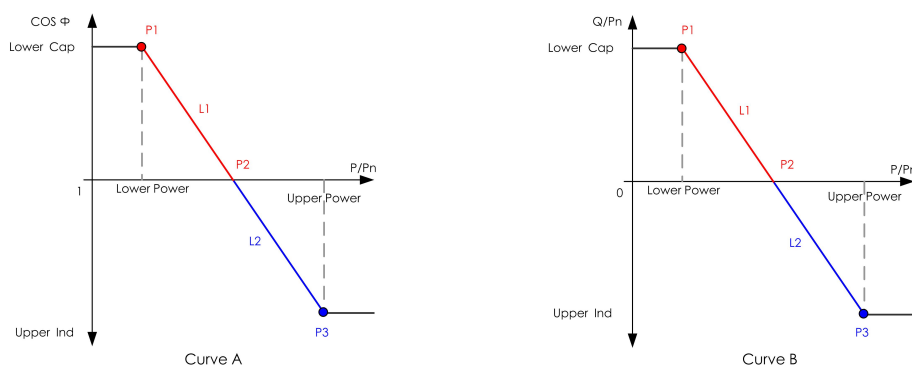

figure 8-4 Q(P) Curve

“Q(U)” Mode

The reactive power output of the inverter will vary in response to the grid voltage.

table 8-3 “Q(U)” Mode Parameter Descriptions:

Parameter	Explanation	Default		Range
		DE	AU	
Q(U) curve	Select corresponding curve according to local regulations		A	A, B, C*
Hysteresis Ratio	Voltage hysteresis ratio on the Q(U) mode curve		0	0 ~ 5%
QU_V1	Grid voltage limit at P1 on the Q(U) mode curve	93%	90%	80% ~ 100%
QU_Q1	Value of Q/Sn at P1 on the Q(U) mode curve	-60%	-30%	-60% ~ 0
QU_V2	Grid voltage limit at P2 on the Q(U) mode curve	97%	95.6%	80% ~ 110%
QU_Q2	Value of Q/Sn at P2 on the Q(U) mode curve		0	-60% ~ 60%
QU_V3	Grid voltage limit at P3 on the Q(U) mode curve	103%	AU: 108.7% NZ: 108.6%	100% ~ 120%

Parameter	Explanation	Default		Range
		DE	AU	
QU_Q3	Value of Q/Sn at P3 on the Q(U) mode curve		0	-60% ~ 60%
QU_V4	Grid voltage limit at P4 on the Q(U) mode curve	107%	AU: 115.2% NZ: 110.8%	100% ~ 120%
QU_Q4	Value of Q/Sn at P4 on the Q(U) mode curve	60%	30%	0 ~ 60%
QU_EnterPower	Active power for Q(U) function activation		80%	20% ~ 100%
QU_ExitPower	Active power for Q(U) function deactivation		10%	1% ~ 20%
QU_EnableMode	Unconditional activation/deactivation of Q(U) function		Yes	Yes / No / Yes, Limited by PF

* Curve C is reserved and consistent with Curve A currently.

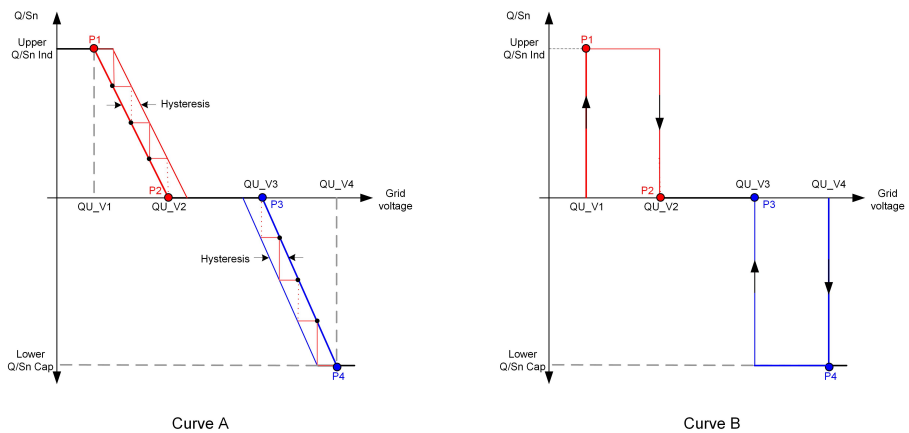

figure 8-5 Q(U) Curve



There is no need to set initialization parameters of the EV charger because it can operate automatically after being identified by iSolarCloud App.

8.6 Function Overview

The app provides the following options for viewing information about the inverter or settings parameters.

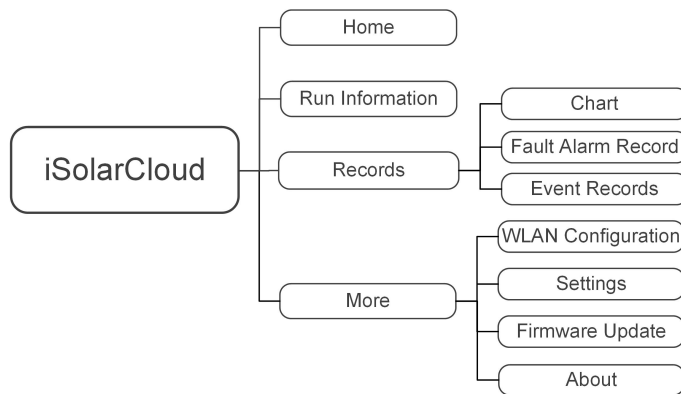

figure 8-6 App Function Tree Map

When a EV-Charger is connected, the app provides the following additional options. This section will appear automatically as soon as the EV-Charger is connected to the hybrid inverter. If the app interface does not change automatically, please logout and login again in Local Access Mode.

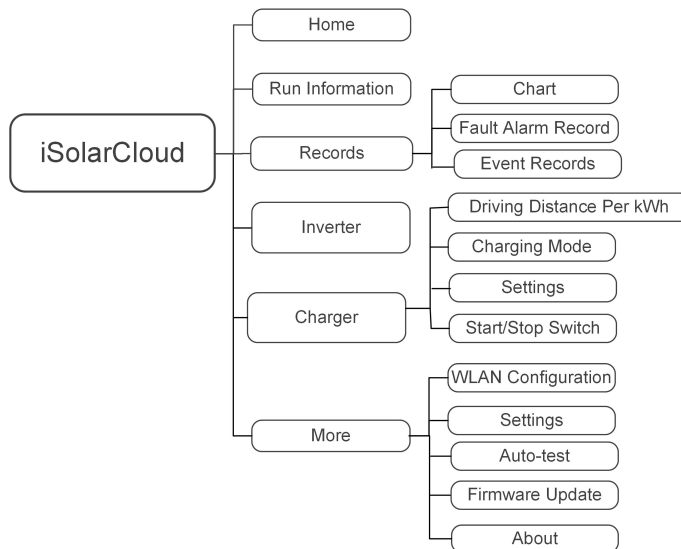

figure 8-7 EV charger-related App Function Tree Map

8.7 Home

Home page of the App is shown in the following figure.

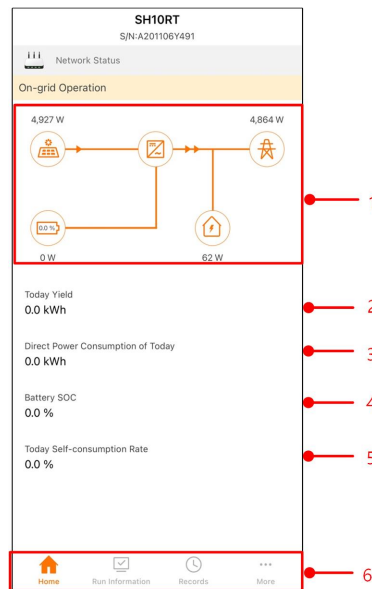



figure 8-8 Home

table 8-4 Home page description

No.	Name	Description
1	Load flow chart	Shows the PV power generation power, feed-in power, etc. The line with an arrow indicates energy flow between connected devices, and the arrow pointing indicates energy flow direction.
2	Today Yield	Shows the energy generated by the inverter today in kWh
3	Direct Power Consumption of Today	Shows the part of the PV generated energy that was directly consumed by the house loads today in kWh
4	Battery SOC	Indicates remaining battery capacity
5	Today Self-consumption Rate	Indicates the self consumption rate of the PV system today
6	Navigation bar	Includes menus of Home , Run Information , Records , and More .

If the inverter runs abnormally, the fault icon  appears on the upper left corner of the screen. Users can tap the icon to view detailed fault information and corrective measures. Home page of a system that contains the Sungrow EV-Charger is shown in the following figure.

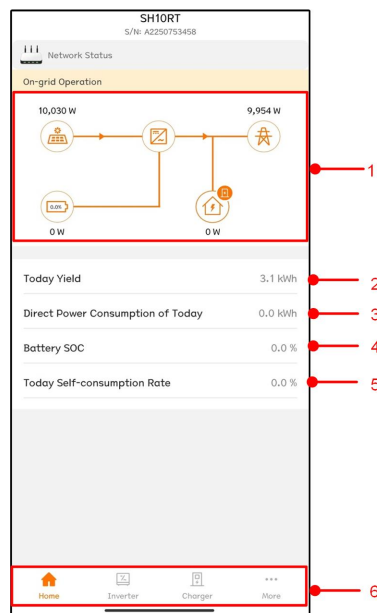

figure 8-9 EV charger Home Page

table 8-5 Home page description

No.	Name	Description
1	Load flow chart	Shows the PV power generation power, feed-in power, etc. The line with an arrow indicates energy flow between connected devices, and the arrow pointing indicates energy flow direction
2	Today yield	Shows the energy generated by the inverter today in kWh
3	Direct power consumption of today	Shows the part of the PV generated energy that was directly consumed by the house loads today in kWh
4	Battery SOC	Indicates remaining battery capacity
5	Today self-consumption rate	Indicates the self consumption rate of the PV system today
6	Navigation bar	Includes Home, Inverter, Charger, More

8.8 Run Information

Tap **Run Information** on the navigation bar to enter the corresponding screen, as shown in the following figure.

RUN INFORMATION	
PV Information ^	
String 1 Voltage	0.0 V
String 1 Current	0.00 A
String 2 Voltage	0.0 V
String 2 Current	0.00 A
Daily PV Yield	0.0 kWh
Total PV Yield	0.0 kWh
Inverter Information ^	
Running Status	Shut Down
Bus Voltage	0.0 V
Internal Air Temperature	24.9 °C
Array Insulation Resistance	0 kΩ
Country (Region) Information	Germany
Ripple Control state	No RIPP Schedule
Power Limitation Mode	Unlimited Power

figure 8-10 Run Information

The run information includes the PV information, inverter information, input, output, grid information, load information, and battery information.

8.9 Records

Tap **Records** on the navigation bar to enter the screen, as shown in the following figure.

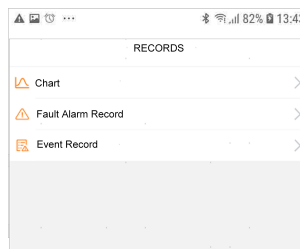

figure 8-11 Records

On **Records** screen, users can view chart and check fault alarm record.

8.9.1 Chart

Tap **Chart** to enter the screen showing daily power generation, as shown in the following figure.

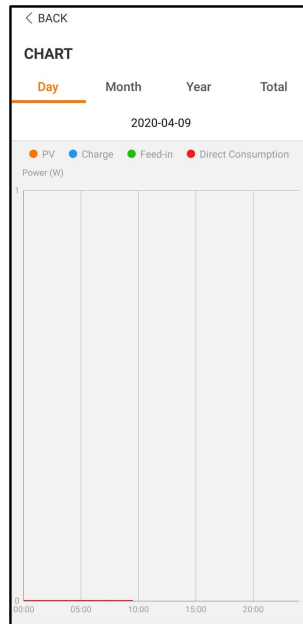

figure 8-12 Power Curve

The App displays power generation records in a variety of forms, including daily power generation graph, monthly power generation histogram, annual power generation histogram, and total power generation histogram.

table 8-6 Description of power generation records

Item	Description
Daily power generation graph	Indicates today power generation, charging, feed-in power, and direct consumption power
Monthly power generation histogram	Indicates monthly power generation, charging, feed-in power, and direct consumption power
Annual power generation histogram	Indicates annual power generation, charging, feed-in power, and direct consumption power
Total power generation histogram	Indicates total power generation, charging, feed-in power, and direct consumption power

8.9.2 Fault Alarm Record

Tap **Fault Alarm Record** to enter the screen, as shown in the following figure.

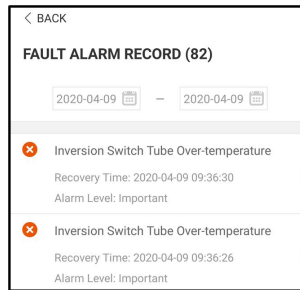

figure 8-13 Fault Alarm Record



Click "📅" to select a time segment and view corresponding records.

Select one of the records in the list and click the record, to view the detailed fault info as shown in following figure.

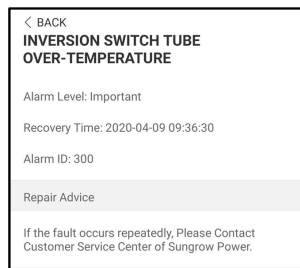

figure 8-14 Detailed fault alarm info

8.9.3 Event Records

Tap **Event Records** to enter the screen, as shown in the following figure.

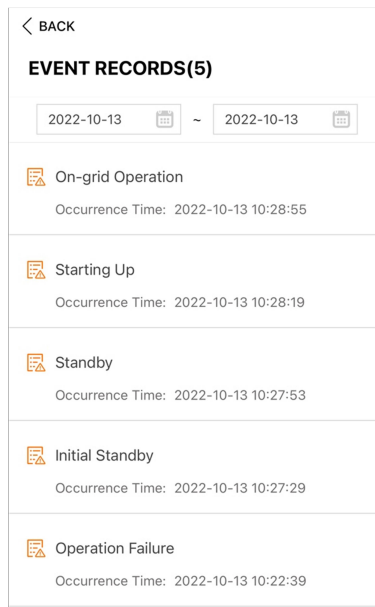

figure 8-15 Event Records

8.10 Inverter (Optional)



This section will only appear once the SUNGROW EV-Charger is connected to the hybrid inverter.

Tap **Inverter** in the navigation bar, and the inverter interface is shown below.

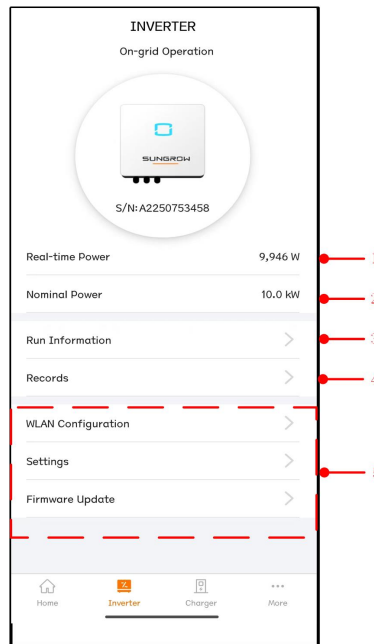

figure 8-16 Inverter

table 8-7 Inverter interface description

No.	Name	Description
1	Real-time power	The current working power of the inverter
2	Nominal power	Maximum load power borne by the inverter
3	Run information	For details, please see "8.8 Run Information"
4	Records	For details, please see "8.9 Records"
5	Inverter configuration	Includes WLAN Configuration, Settings, Firmware Update . For details, please see "8.12 More"

8.11 EV-Charger (Optional)



This section applies only in combination with the Sungrow three-phase Hybrid and SBR storage system that includes the Sungrow AC-Charger AC011E-01.

Tap **EV-Charger** in the navigation bar, and the EV-Charger interface is shown below.

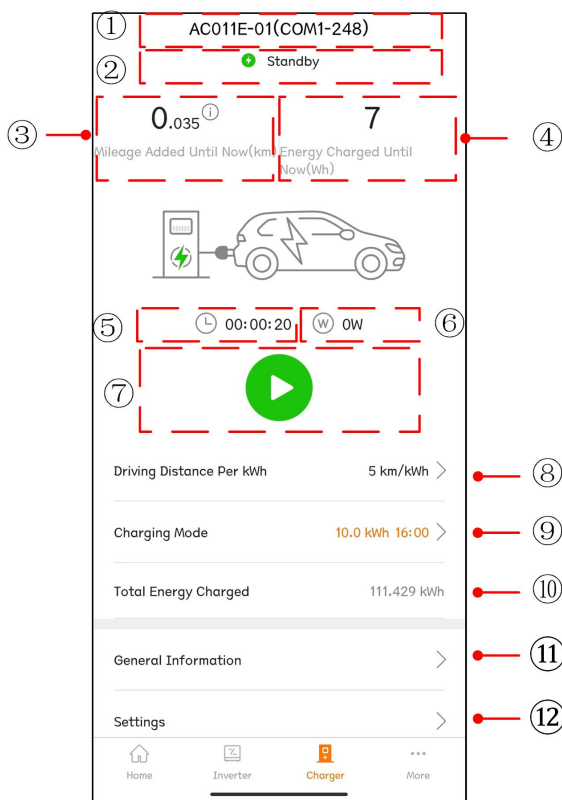

figure 8-17 EV-Charger

table 8-8 EV Charger interface description

No.	Name	Description
1	Charger name	Shows the name of the connected EV-Charger
2	Charger status	Shows the current running status of a EV charger, which includes Unplugged, Standby, Charging, Charging Complete, and Disable
3	Mileage added until now	Shows the driving distance added by this charge
4	Energy charged until now	Shows the charged energy from the start of the EV-Charger to the current moment
5	Charge duration	Shows the time from the start of the EV-Charger to the current moment
6	Charging power	Shows the charging power at the current moment
7	Start/Stop switch	Tap this button to start or stop charging. It cannot be operated if it is gray. For details, see "8.11.4 Start/Stop Switch"
8	Driving distance per kWh	For details, see "8.11.1 Driving Distance Per kWh"

No.	Name	Description
9	Charging mode	The charging modes of the EV-Charger. For details, see " 8.11.2 Charging Mode "
10	Total Energy Charged	Shows the cumulative charged energy from the initial charge to the current moment
11	General information	General operation information of the EV-Charger and the inverter, including Charger Status, Charging Power, Charge, Charging Voltage and Charging Current
12	Settings	EV-Charger parameter setting, including whether to enable the EV-Charger or not

8.11.1 Driving Distance Per kWh

Tap **Driving Distance Per kWh** to enter the corresponding interface.

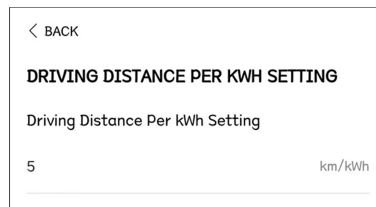

figure 8-18 Driving Distance Per kWh Setting

Driving distance per kWh is the driving distance in 1kWh of the vehicle that is being charged, and the default value is 5km/kWh. Users can set the value according to the actual vehicle condition and battery loss.

8.11.2 Charging Mode

There are four charging modes: green power charging, fast charging, preset charging, and customized charging.

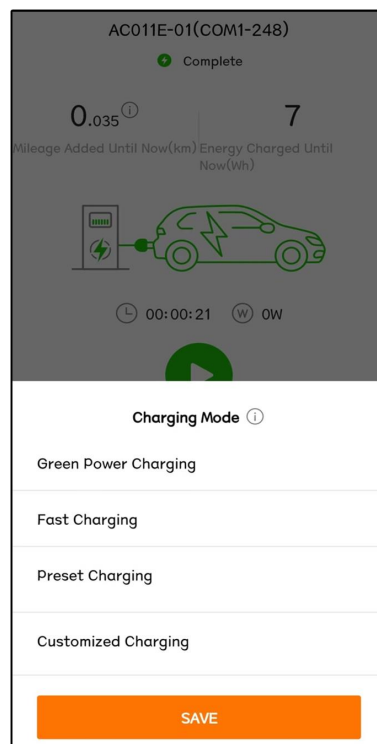



figure 8-19 Four Charging Modes



- If fail to set the mode, restart the App and try again. If the mode still cannot be set, contact the distributor first. If the problem persists, contact SUNGROW.
- The four charging modes of the EV-Charger can be used in the self-consumption mode of the inverter. When the inverter is in the external EMS mode, the EV-Charger can be used only in the preset charging mode.
- The four modes can be switched between each other during the charging process. After switching, the charging will stop. Please tap  to continue charging if necessary. If it is switched to "Customized" mode and the moment is not within the set charging time, it will prompt "**The current charge is completed and will continue according to the customized time**".

Green Power Charging

This mode is the most economical charging mode in which the EV-Charger take priority to use PV energy to charge the vehicle while not affecting the power consumption of other household appliances.

If the PV power is lower than the minimum charging power of the EV-Charger, the battery and the power grid shall supplement the power.

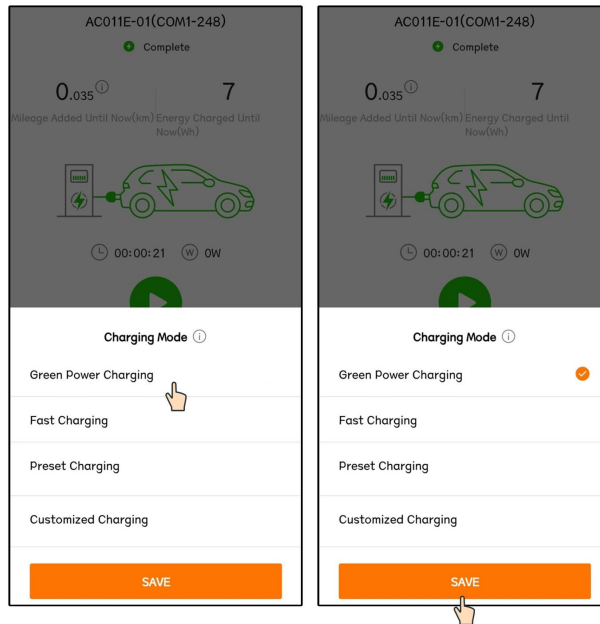

figure 8-20 Green Power Charging

Select **Green power Charging** and tap **Save**.

Fast Charging

The EV-Charger can charge the vehicle with the maximum available power in this mode while not affecting the power consumption of other household appliances. In this case, the charging power may come from PV modules, batteries, power grid or all. Users can choose this mode when they need to charge the vehicle urgently.

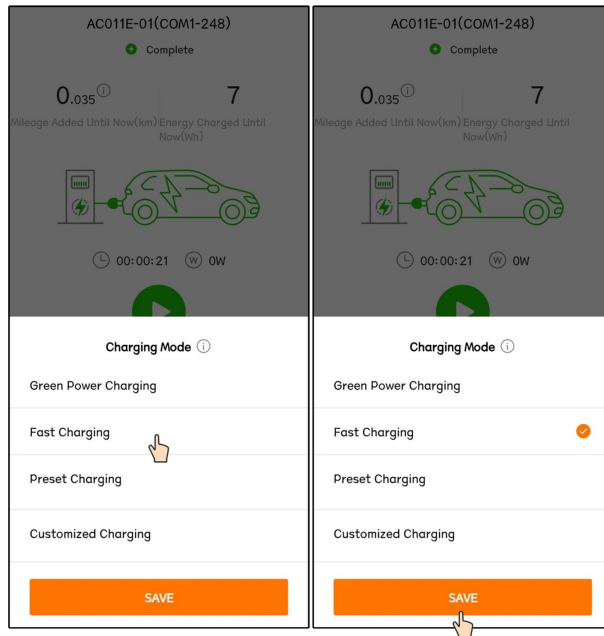

figure 8-21 Fast Charging

Select **Fast Charging** and tap **Save**.

Preset Charging

In this mode, the user can input the amount of kWh they want to charge, as well as the expected pickup time, the system will intelligently switch between in the green power charging mode and fast charging mode, so that the vehicle can be charged at the lowest cost before it is picked up by the user.

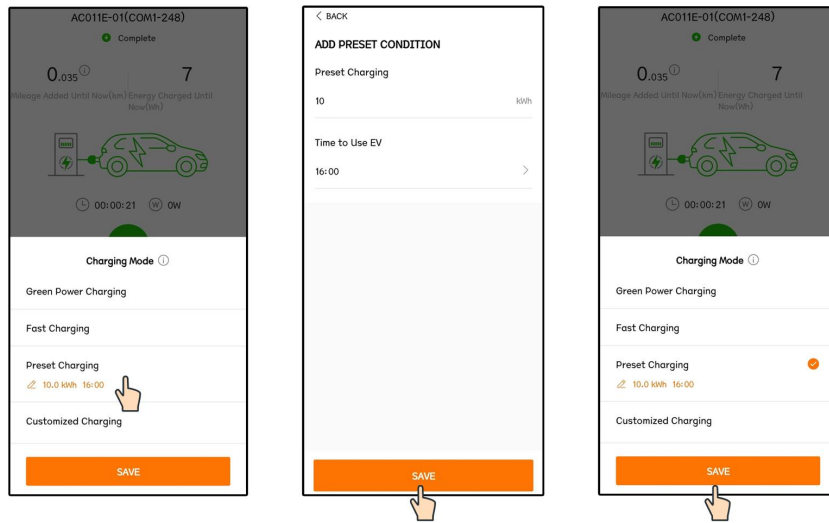

figure 8-22 Preset Charging

Tap **Preset Charging** to enter the **Add Preset Condition** interface. Input **Preset Charge** and **Time to Use EV**, and tap **Save**. It will jump to the preset charging mode interface. Tap **Save** again to finish setting.



- If the EV-Charger has delivered the set amount of energy to the EV before the preset pickup time, the charging will end in advance.
- If the EV-Charger is not able to deliver the set amount of energy before the preset pickup time, the App will prompt **"Unable to complete the charging target before you pick up the vehicle"**. Select **"Continue"** to save the settings or select **"Cancel"** to go back to the preset condition interface.

Customized Charging

In this mode, users set the times at which the EV-Charger should start and stop charging, and the max charging current. The charging power may come from PV modules, batteries, power grid or all.

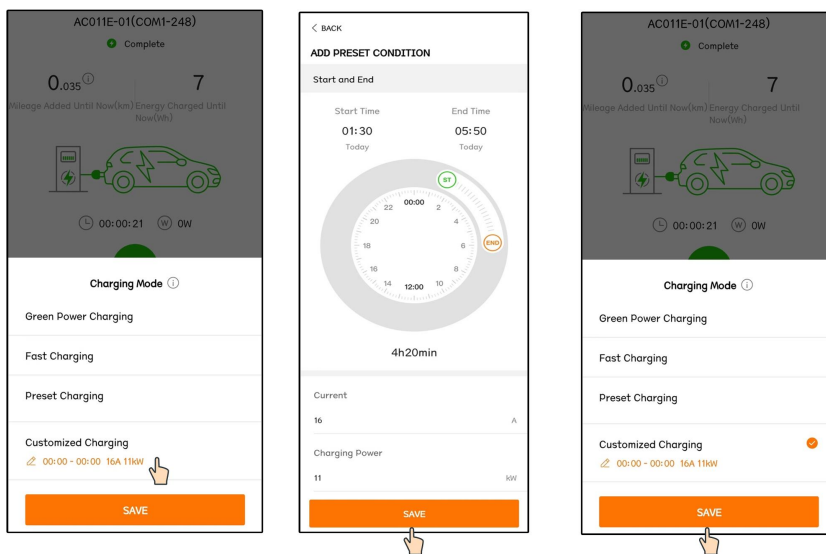

figure 8-23 Customized Charging

Select **Customized Charging** to enter the **Add Preset Condition** interface, drag to set the charging start time and end time, input **Current** and **Charging Power**, and tap **Save**. It will jump to the customized charging interface. Tap **Save** again to finish setting.

- The minimum unit of charging time is 10 minutes.
- The current is the maximum allowable current of the EV-Charger to charge the on-board system, and the charging power is the maximum allowable charging power of the EV-Charger to charge the on-board system. The current and the corresponding charging power can be set as follows:

Current (A)	6	8	10	12	14	16
Power (kW)	4.14	5.52	6.9	8.28	9.66	11

i

- In this mode, the EV-Charger starts charging automatically at the set charging time.
- If the moment is within the set charging time and the charging cable has been inserted into the EV, click "Save" on the charging mode interface and the EV-Charger will immediately start charging the EV.

8.11.3 Parameter Setting

Tap **Settings** to enter the corresponding interface.

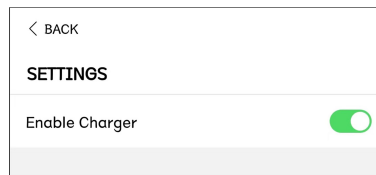



figure 8-24 Parameter Setting

Tap the switch to enable the charger.

Tap the switch again to disable the charger, in this case the charger will be in **"Disable"** status.

8.11.4 Start/Stop Switch

This switch is not visible in the installer access profile, please login with "user" to see this.

If the charging cable is inserted into the EV, and the parameters are set, the EV-Charger will be in a **"Standby"** status. Tap , the EV-Charger starts working and turns from **"Standby"** into **"Charging"**. Pull out the charging cable after the charge is completed.

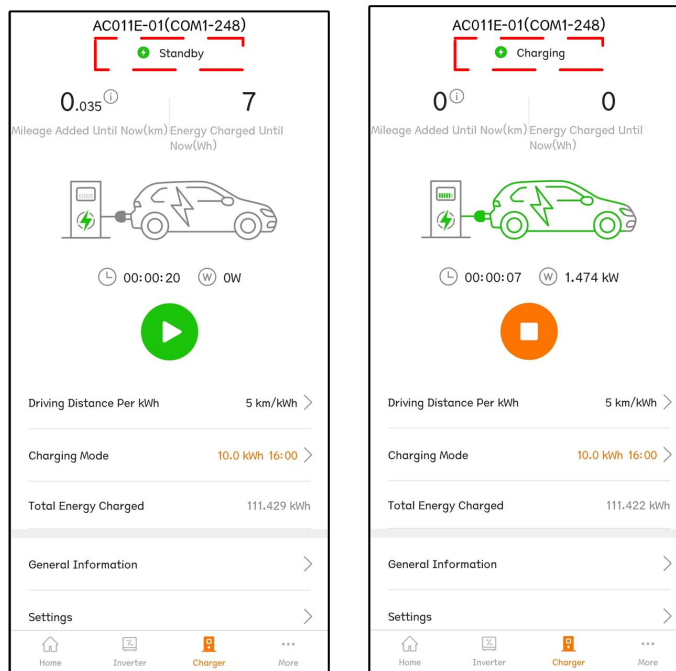

If the EV-Charger is in a **"Unplugged"** status after the charging mode is set, the charging cable may not be inserted in place. Check the connection or reconnect the cable to the EV.

To stop charging during the charging process, tap . At this time, the charging status from **"Charging"** to **"Complete"**.

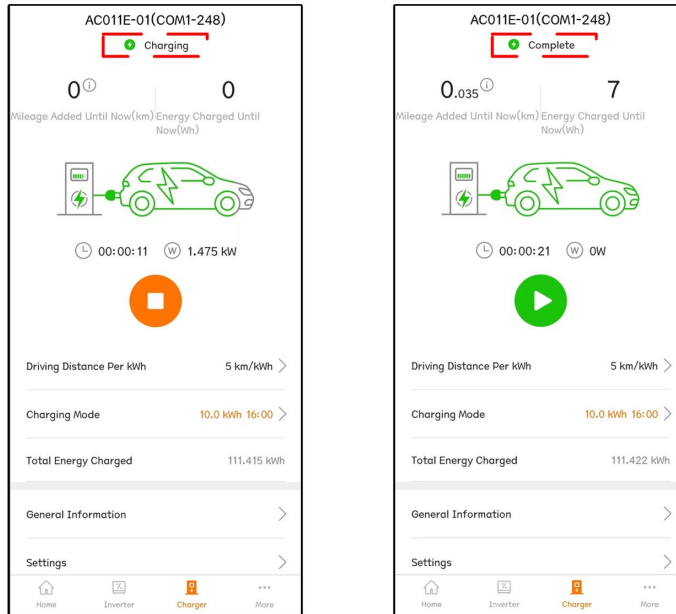

- Only the end user account has permission to turn on/off the EV-Charger.
- The EV-Charger can be started and stopped on iSolarCloud App or by the charging card. Please start and stop a charger in the same way in a single charge.

8.12 More

Tap **More** on the navigation bar to enter the screen, as shown in the following figure.

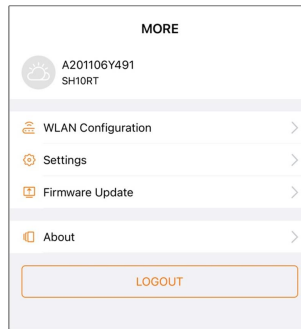
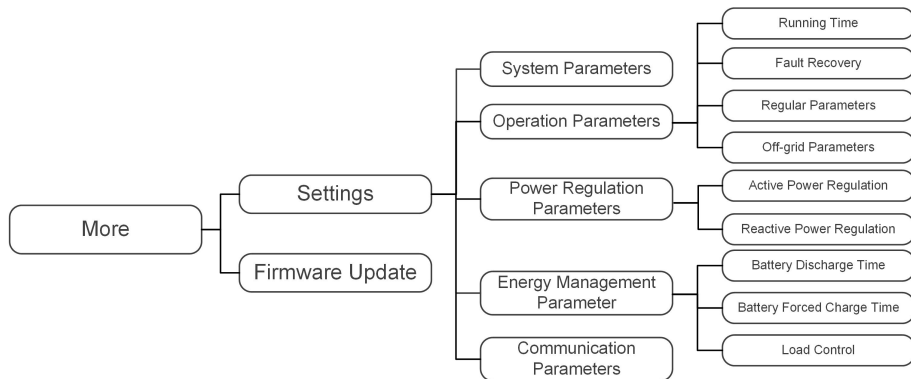

figure 8-25 More



The **More** screen supports the following operations:

- Set parameters including inverter system parameters and energy management parameter.
- Upgrade inverter firmware of the communication module.

8.12.1 System Parameters

Tap **Settings**→**System Parameters** to enter the corresponding interface, as shown in the following figure.

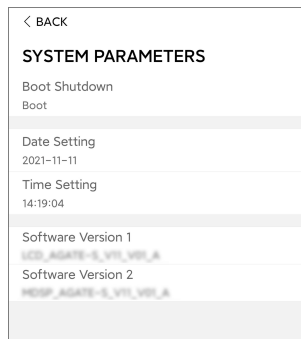

figure 8-26 System Parameters

* The image shown here is for reference only.

Boot/Shutdown

Tap **Boot/Shutdown** to send the boot/shutdown instruction to the inverter.

For Australia and New Zealand, when the DRM state is DRM0, the "Boot" option will be prohibited.

Date Setting/Time Setting

The correct system time is very important. Wrong system time will directly affect the data logging and power generation value. The clock is in 24-hour format.

Software Version

Version information of the current firmware.

8.12.2 Running Time

Tap **Settings**→**Operation Parameters**→**Running Time** to enter the corresponding screen, on which you can set **Connecting Time** and **Reconnecting Time**.

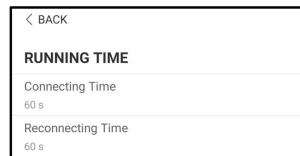

figure 8-27 Running Time

table 8-9 Description of running time parameters

Parameter	Explanation	Default	Range
Connecting Time	The time that the inverter takes to enter into the running mode from the standby mode in fault-free state	60s	10s ~ 900s
Reconnecting Time	The time that the inverter takes to recover from the fault state to normal state (the inverter is not running)	60s	0s ~ 3600s

8.12.3 Fault Recovery

Tap **Settings**→**Operation Parameters**→**Fault Recovery** to enter the corresponding screen, on which you can see the fault recovery records.

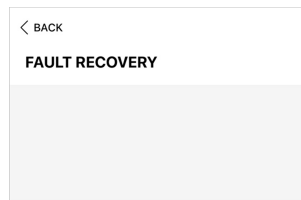

figure 8-28 Fault Recovery

8.12.4 Regular Parameters

Tap **Settings**→**Operation Parameters**→**Regular Parameters** to enter the screen, as shown in the following figure.

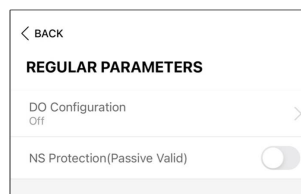

figure 8-29 Regular Parameters

After connecting the load to the DO terminals, a relay control signal will be transmitted. Users can flexibly set the control mode of DO configuration according to individual demand. NS protection is enabled, and the inverter stops in an emergency.

table 8-10 The control mode of DO configuration

Mode	Setting description
Off	-
Load Control Mode	See "8.12.10 Load Control"
Grounding Detection	See "8.12.13 Grounding Detection"

8.12.5 Off-grid Parameters

Tap **Settings**→**Operation Parameters**→**Off-grid Parameters** to enter the screen, as shown in the following figure.

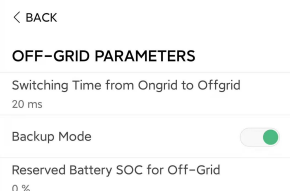

figure 8-30 Off-grid Parameters

Refer to the description in "[8.5.2 Backup Mode](#)".

8.12.6 Active Power Regulation

Tap **Settings**→**Power Regulation Parameters**→**Active Power Regulation** to enter the screen, as shown in the following figure.

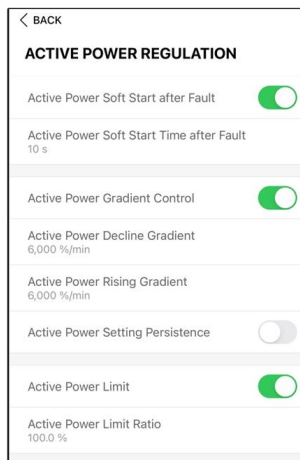

figure 8-31 Active Power Regulation

table 8-11 Description of active power regulation

Parameter	Description	Default	Range
Active Power Soft Start after Fault	Switch for activating/deactivating the function of active power soft start after a fault occurs	On	On/Off
Active Power Soft Start Time after Fault	The soft start time required for raising active power from 0 to rated value after a fault occurs	600s	1s ~ 1200s
Active Power Gradient Control	Set whether to enable active power gradient control	On	On/Off
Active Power Decline Gradient	Decline gradient of inverter active power per minute	39%/min	1%/min ~ 6000%/min
Active Power Rising Gradient	Rising gradient of inverter active power per minute		
Active Power Setting Persistence	Switch for activating/deactivating the function of active power setting persistence	Off	On/Off
Active Power Limit	Switch for limiting active power	On	On/Off
Active Power Limit Ratio	The ratio of active power limit to rated power in percentage	100.0%	0 ~ 100%

8.12.7 Reactive Power Regulation

Tap **Settings**→**Power Regulation Parameters**→**Reactive Power Regulation** to enter the screen, as shown in the following figure.

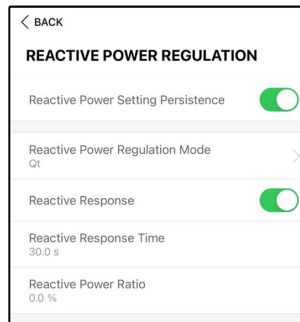

figure 8-32 Reactive Power Regulation

table 8-12 Description of reactive power regulation

Parameter	Description	Default	Range
Reactive Power Setting Persistence	Switch for activating/deactivating the function of reactive power setting persistence	On	On / Off
Reactive Power Regulation Mode	See " 8.5.3 Reactive Power Regulation Mode "	Off	Off / PF / Qt / Q(P) / Q(U)
Reactive Response	Reactive response function on and off	On	On / Off
Reactive Response Time	Reactive power response time	30.0s	0.1s — 600s
Reactive Power Ratio	Ratio of reactive power	0.0%	0.0% — 100%

8.12.8 Battery Discharge Time

Tap **Settings**→**Energy Management Parameter**→**Battery Discharge Time** to enter the corresponding screen, as shown in the following figure.

These are the times of day at which the battery is allowed to discharge to the house loads.

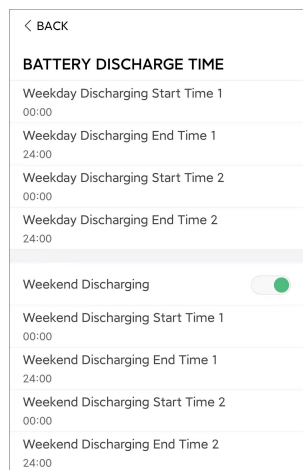

figure 8-33 Battery Discharge Time

8.12.9 Battery Forced Charge Time

Tap **Settings**→**Energy Management Parameter**→**Battery Forced Charge Time** to enter the corresponding screen.

These are the times of day at which the inverter will start charging the battery with rated AC power.

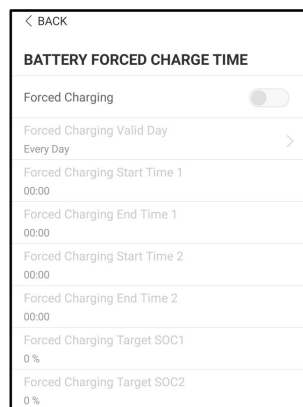

figure 8-34 Battery Forced Charge Time

When there is no PV power, the power imported from the grid charges the energy system during the time period until the target SOC is reached.

It is recommended to set the time period in off-peak tariff time. The time period 1 is in priority to the time period 2 if two periods overlap. The charging energy comes from the excess PV energy in priority and then from the grid. The inverter will take charging power from the grid in the case of PV energy shortage.

8.12.10 Load Control

Tap **Settings**→**Energy Management Parameter**→**Load Control** to enter the corresponding screen, on which you can set **Load Control Mode**. Load Control Mode includes **Timing Mode**, **Switch Mode**, and **Intelligent Mode**.

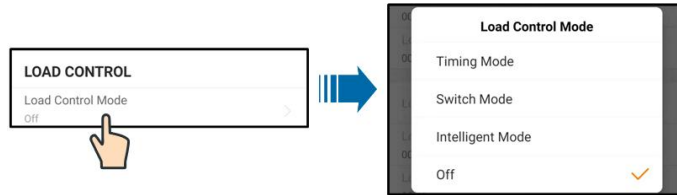

figure 8-35 Load Control

Timing Mode

In this mode, set the **Load Timing Start Time 1** and **Load Timing End Time 1**, the system will control the load operation during the interval. Take 09:00 am–09:30 am as an example.

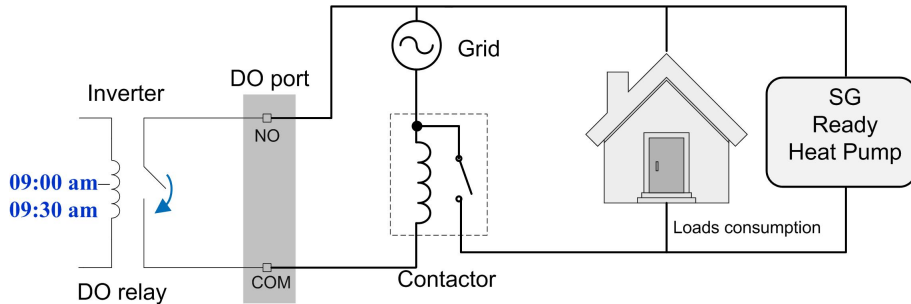

figure 8-36 DO Operation in Timing Mode

Switch Mode

In this mode, the system will control the load operation according to the setting. In the following example, the switch is set to OFF.

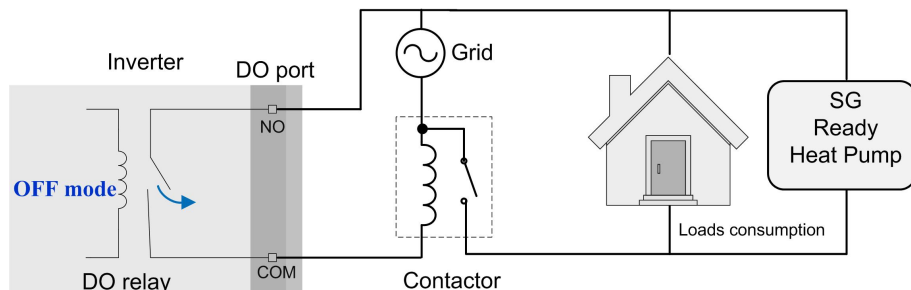

figure 8-37 DO Operation in Switch Mode

Intelligent Mode

The system will control the load operation according to the power optimization algorithm of energy management.

During the setting interval, the DO function will be enabled to power on the load if the excess PV energy exceeds the optimized power value.

Notice:

The intelligent mode is disabled in an off-grid system.

- When the inverter is installed to retrofit an existing PV system, the upper limit of optimized power is the sum of the rated power of the hybrid inverter and the rated power of the existing PV inverter.
- Once the intelligent mode is enabled, the DO relay will remain connected for 20 minutes after the DO connection.

Take 09:00 am–09:30 am and the optimized power of 1000 W as an example.

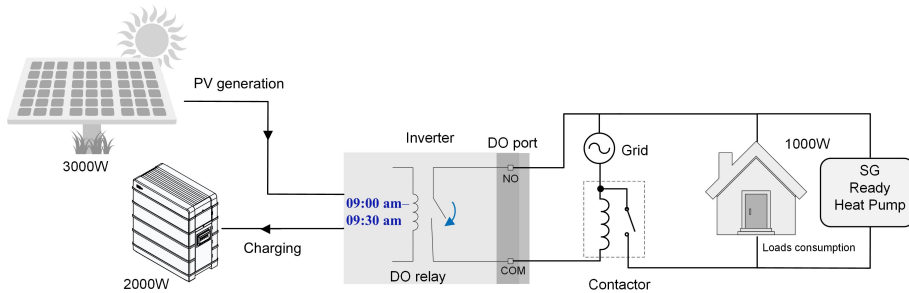

figure 8-38 DO Operation in Intelligent Mode

8.12.11 Communication Parameters

Tap **Settings**→**Communication Parameters** to enter the screen, as shown in the following figure.

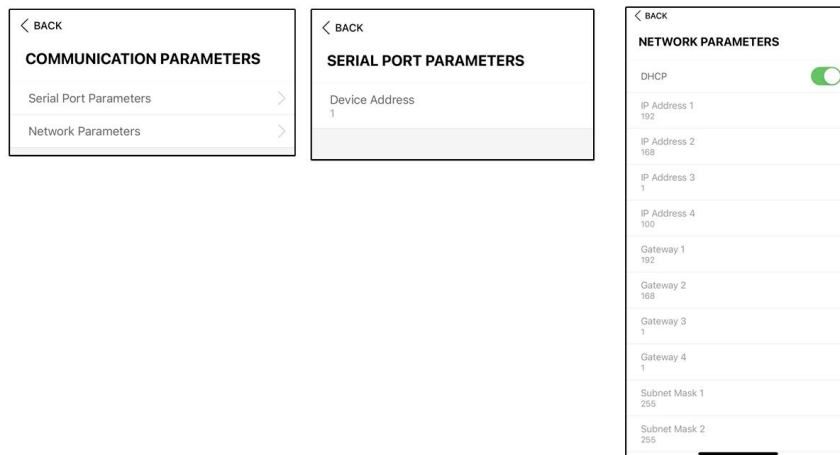



figure 8-39 Communication Parameters

- The device address ranges from 1 to 246.
- The IP address, gateway, subnet mask, preferred DNS server and alternate DNS server can be modified only when the DHCP is set to Off.
- Acquire the IP address, gateway, subnet mask, preferred DNS server and alternate DNS server from the network professional.

8.12.12 Firmware Update

To avoid download failure due to poor on-site network signal, it is recommended to download the firmware package to the mobile device in advance.

- step 1 Enable the "Mobile data" of the mobile device.
- step 2 Open the App, enter the account and password on the login screen. Tap **Login** to enter the home screen.
- step 3 Tap **More**→**Firmware Download** to enter corresponding screen on which you can view the device list.
- step 4 Select the device model before downloading the firmware. Tap the device name in the device list to enter the firmware upgrade package detail interface, and tap  behind the firmware upgrade package to download it.

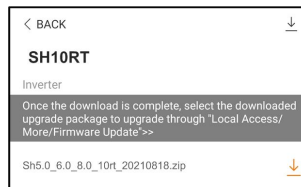

- step 5 Return to the **Firmware Download** screen, tap  in the upper right corner of the screen to view the downloaded firmware upgrade package.
- step 6 Login the App via local access mode. Refer to "8.4 Login".
- step 7 Tap **More** on the App home screen and then tap **Firmware Update**.
- step 8 Tap the upgrade package file, a prompt box will pop up asking you to upgrade the firmware with the file, tap **CONFIRM** to perform the firmware upgrade.



- step 9 Wait for the file to be uploaded. When the upgrade is finished, the interface will inform you of the upgrade completion. Tap **Complete** to end the upgrade.

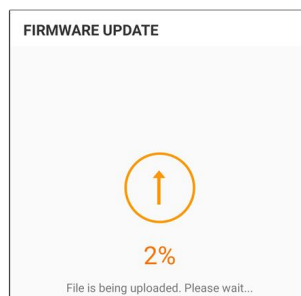

-- End

8.12.13 Grounding Detection



Contact your distributor to obtain the advanced account and corresponding password before setting the earth detection parameters. If the distributor is unable to provide the required information, contact SUNGROW.

Unauthorized personnel are not allowed to log in with this account. Otherwise, SUNGROW shall not be held liable for any damages caused.

Tap **More**→**Settings**→**Operation Parameters**→**Grounding Detection** to enter the corresponding screen.



figure 8-40 Grounding Detection

If the grounding detection is enabled, the DO relay will switch on automatically to signal the external alarm if the value exceeds the grounding detection alarm value. The buzzer inside the inverter will beep.

The PV insulation resistance fault (fault sub-code 039) will trigger the DO relay to signal the external alarm.

8.12.14 Parallel Configuration

When two or more inverters are connected in parallel, the inverter needs to be set as the master or slave.

Tap **More**→**Settings**→**Power Regulation Parameters**→**Feed-in Limitation** to enter the corresponding screen.

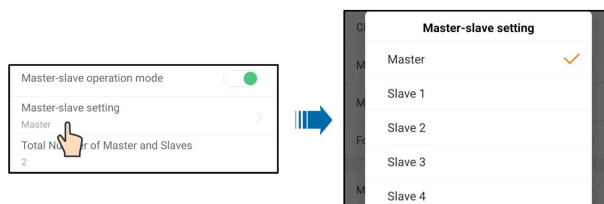

Parameter	Default value	Range
Master-slave operation mode	ON	ON / OFF
Master-slave setting	Master	Master / Slave 1 / Slave 2 / Slave 3 / Slave 4
Total Number of Master and Slaves	2	2 ~ 5

8.12.15 Frequency Shift Power Control

Tap **More**→**Settings**→**Operation Parameters**→**Other Parameters** to enter the corresponding screen.



Parameter	Default value	Range
Frequency Shift Power Control	OFF	ON / OFF
Frequency Shift Test	OFF	ON / OFF
Set Test Frequency	50.00 Hz	50.00 ~ 55.00 Hz

If PV inverters are connected on the AC side during battery-backup operation, the hybrid inverter must be able to limit their output power. This limitation becomes necessary when, for example, the hybrid inverter's battery is fully charged and the power available from the PV system exceeds the power requirement of the connected loads.

To prevent excess energy from overcharging the battery, the hybrid inverter automatically detects the problem and changes the frequency at the AC output. This frequency adjustment is analyzed by the PV inverter. As soon as the power frequency of the battery-backup grid increases beyond the value specified in **Set Test Frequency**, the PV inverter limits its output power accordingly.

Before retrofitting the existing PV system to an off-grid port, the **Frequency Shift Power Control** parameter needs to be enabled. It must be ensured that the connected PV inverters limit their power at the AC output via the hybrid inverter due to changes in frequency. The frequency-dependent active power limitation PF must be set in the PV inverter.



When the battery SOC is greater than 85%, the Hybrid inverter will standby before starting when switching off-grid, and does not support seamless switching.

8.12.16 Energy Management Mode

Tap **Settings**→**Energy Management Parameters**→**General Parameters**→**Energy Management Mode** to enter the screen, as shown in the following figure.

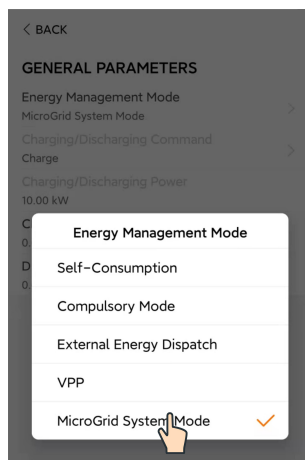

figure 8-41 Energy Management Mode

Parameter	Description
Self-Consumption Mode	The normal operation mode of the inverter, where the inverter will cover the house load with PV and battery power. If the PV is higher than the load and the battery is full, the power will be injected in the grid according to the Feed-in Limitation settings.
Compulsory Mode	The Force Charge or Force Discharge of the battery. Set the Force Charge or Discharge power and the battery will charge/discharge to the house load or the grid.
External Energy Dispatch	The inverter is controlled by an external energy management system through Modbus RTU or TCP.
VPP	The inverter receives charge and discharge commands from an external VPP system.

8.12.17 MicroGrid System Parameters

Tap **Settings** → **Energy Management Parameters** → **MicroGrid System Parameters** to enter the screen, as shown in the following figure.

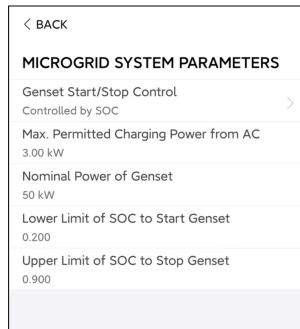

figure 8-42 MicroGrid System Parameters

table 8-13 Description of microgrid system parameters

Parameter	Description	Default	Range
Genset Start/Stop Control	Select how to start and stop the genset	Controlled by SOC	Forced Stop / Forced Start / Controlled by SOC
Max. Permitted Charging Power from AC	The allowable maximum charging power of batteries from AC side	30 kW	0 kW ~ 500 kW
Nominal Power of Genset	Nominal power of the genset, which is limited to less than 50 kW. The sum of the inverter power and the load power shall not be higher than the nominal power of the genset. Removed non-critical loads if necessary.	50 kW *	0 kW ~ 500 kW
Lower Limit of SOC to Start Genset	When the SOC reaches the lower limit, the genset is started to supply power to loads and charge batteries. It is only displayed when the genset on/off is controlled by SOC.	20%	0 ~ 100%
Upper Limit of SOC to Stop Genset	When the SOC reaches the upper limit, the genset is stopped and the inverter supplies power to loads. It is only displayed when the genset on/off is controlled by SOC.	90%	0 ~ 100%

* Set this parameter based on the actual maximum power of the genset. The recommended maximum power of the genset is twice the rated power of the inverter parallel system.

8.12.18 DO Configuration

Tap **Settings**→**Operation Parameters**→**Regular Parameters**→**DO Configuration** to enter the screen, as shown in the following figure.

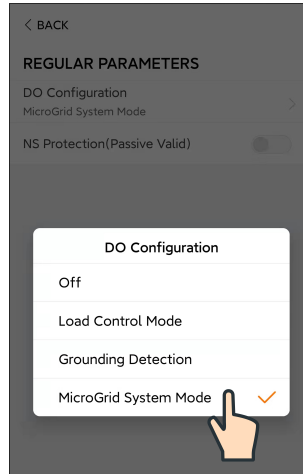

figure 8-43 DO Configuration

9 System Decommissioning

9.1 Decommissioning the Inverter

9.1.1 Disconnecting Inverter

⚠ CAUTION

Danger of burns!

Even if the inverter is shut down, it may still be hot and cause burns. Wear protective gloves before operating the inverter after it cools down.

For maintenance or other service work, the inverter must be switched off.

Proceed as follows to disconnect the inverter from the AC and DC power sources. Lethal voltages or damage to the inverter will follow if otherwise.

- step 1 Stop the inverter via the iSolarCloud App. For details, see "[8.12.1 System Parameters](#)".
- step 2 Disconnect the external AC circuit breaker and prevent it from inadvertent reconnection
- step 3 Rotate the DC switch to the "OFF" position for disconnecting all of the PV string inputs.
- step 4 Disconnect the DC circuit breaker between the battery and the inverter.

NOTICE

Do not power on the system again for 1 minute after the disconnection.

- step 5 Wait about 10 minutes until the capacitors inside the inverter completely discharge.
- step 6 Ensure that the DC cable is current-free with a current clamp.

-- End

9.1.2 Dismantling the Inverter

⚠ CAUTION

Risk of burn injuries and electric shock!

After the inverter is powered off for 10 minutes, measure the voltage and current with professional instrument. Only when there is no voltage nor current can operators who wear protective equipment operate and maintain the inverter.

Before dismantling the inverter, disconnect both AC and DC connections.

If there are more than two layers of inverter DC terminals, dismantle the outer DC connectors before dismantling the inner ones.



If the original packing materials are available, put the inverter inside them and then seal them using adhesive tape. If the original packing materials are not available, put the inverter inside a cardboard box suitable for the weight and size of this inverter and seal it properly.

- step 1 Refer to "[6 Electrical Connection](#)" for the inverter disconnection of all cables in reverse steps.
- step 2 Dismantle the inverter referring to "[5 Mechanical Mounting](#)" in reverse steps.
- step 3 If necessary, remove the wall-mounting bracket from the wall.
- step 4 If the inverter will be reinstalled in the future, please refer to "[4.3 Inverter Storage](#)" for a proper conservation.

-- End

9.1.3 Disposal of Inverter

Users take the responsibility for the disposal of the inverter.

WARNING

Please scrap the inverter in accordance with relevant local regulations and standards to avoid property losses or casualties.

NOTICE

Some parts of the inverter may cause environmental pollution. Please dispose of them in accordance with the disposal regulations for electronic waste applicable at the installation site.

9.2 Decommissioning the Battery

Decommission the battery in the system after the inverter is decommissioned. Proceed as follows to decommission a Li-ion battery.

- step 1 Disconnect the DC circuit breaker between the battery and the inverter.
- step 2 Disconnect the communication cable between the battery and the inverter.
- step 3 **(Optional)** Turn off the switch on LG Chem Li-ion battery or BYD Li-ion battery, if applicable.
- step 4 Wait for about 1 minute and then use the multimeter to measure the port voltage of the battery.
- step 5 If the battery port voltage is zero, disconnect the power cables from the battery module.

-- End



For disposal of this product, please call the phone number listed in the warranty booklet provided at the time of purchase.

10 Troubleshooting and Maintenance

10.1 Troubleshooting



Please refer to the charger user manual for the fault code of the charger.

When an alarm occurs, the alarm information can be viewed through the App.

Alarm ID and corrective measures are as follows:

Alarm ID	Alarm Name	Corrective Measures
002, 003, 014, 015	Grid Overvoltage	<p>Generally, the inverter will be reconnected to the grid after the grid returns to normal. If the fault occurs repeatedly:</p> <ol style="list-style-type: none">1. Measure the actual grid voltage, and contact the local electric power company for solutions if the grid voltage is higher than the set value.2. Check whether the protection parameters are appropriately set via the App or the LCD. Modify the overvoltage protection values with the consent of the local electric power operator.3. If the fault still exists, contact SUNGROW.
004, 005	Grid Undervoltage	<p>Generally, the inverter will be reconnected to the grid after the grid recovers. If the alarm occurs frequently:</p> <ol style="list-style-type: none">1. Measure the grid voltage, and contact the local utility grid company for solutions if the grid voltage is below the specified value.2. Check, through the App, whether the protection parameters are appropriately set.3. Check whether the AC cable is firmly in place.4. If the alarm persists, contact SUNGROW.

Alarm ID	Alarm Name	Corrective Measures
008	Grid Overfrequency	<p>Generally, the inverter will be reconnected to the grid after the grid recovers. If the alarm occurs frequently:</p> <ol style="list-style-type: none"> 1. Measure the grid frequency, and contact the local utility grid company for solutions if the grid frequency is beyond the specified range.
009	Grid Underfrequency	<ol style="list-style-type: none"> 2. Check, through the App, whether the protection parameters are appropriately set. 3. If the alarm persists, contact SUNGROW.
010	Grid Power Outage	<p>Generally, the inverter will be reconnected to the grid after the grid recovers. If the alarm occurs frequently:</p> <ol style="list-style-type: none"> 1. Check whether the grid supplies power reliably. 2. Check whether the AC cable is firmly in place. 3. Check whether the AC cable is correctly connected (whether the live wire and the N wire are in correct place). 4. Check whether the AC switch or circuit breaker is disconnected. 5. If the alarm persists, contact SUNGROW.
012	Excessive Leakage Current	<ol style="list-style-type: none"> 1. The alarm can be caused by poor sunlight or damp environment, and the inverter will be reconnected to the grid after the environment is improved. 2. If the environment is normal, check whether the AC and DC cables are well insulated. 3. If the alarm persists, contact SUNGROW.
013	Grid Abnormal	<p>Generally, the inverter will be reconnected to the grid after the grid recovers. If the alarm occurs frequently:</p> <ol style="list-style-type: none"> 1. Measure the grid frequency, and contact the local utility grid company for solutions if the grid frequency exceeds the specified value. 2. If the alarm persists, contact SUNGROW.

Alarm ID	Alarm Name	Corrective Measures
017	Grid Voltage Unbalance	<p>Generally, the inverter will be reconnected to the grid after the grid returns to normal. If the fault occurs repeatedly:</p> <ol style="list-style-type: none"> 1. Measure the actual grid voltage. If grid phase voltages differ greatly, contact the electric power company for solutions. 2. If the voltage difference between phases is within the permissible range of the local power company, modify the grid voltage imbalance parameter through the App. 3. If the fault still exists, contact SUNGROW.
028, 029	PV Reverse Connection Fault	<ol style="list-style-type: none"> 1. Check whether the corresponding string is of reverse polarity. If so, disconnect the DC switch and adjust the polarity when the string current drops below 0.5 A. 2. If the fault still exists, contact SUNGROW. <p>*The code 28 to code 29 are corresponding to PV1 to PV2 respectively.</p>
037	High Ambient Temperature	<p>Generally, the inverter will resume operation when the internal or module temperature returns to normal. If the fault persists:</p> <ol style="list-style-type: none"> 1. Check whether the ambient temperature of the inverter is too high; 2. Check whether the inverter is in a well-ventilated place; 3. Check whether the inverter is exposed to direct sunlight. Shield it if so; 4. Check whether the fan is running properly. Replace the fan if not; 5. If the fault still exists, contact SUNGROW.

Alarm ID	Alarm Name	Corrective Measures
039	Low System Insulation Resistance	<p>Wait for the inverter to return to normal. If the fault occurs repeatedly:</p> <ol style="list-style-type: none"> 1. Check whether the ISO resistance protection value is excessively high via the app, and ensure that it complies with the local regulations. 2. Check the resistance to ground of the string and DC cable. Take corrective measures in case of short circuit or damaged insulation layer. 3. If the cable is normal and the fault occurs on rainy days, check it again when the weather turns fine. 4. If there are batteries, check whether battery cables are damaged and whether terminals are loose or in poor contact. If so, replace the damaged cable and secure terminals to ensure a reliable connection. 5. If the fault still exists, contact SUNGROW.
106	Grounding Cable Fault	<ol style="list-style-type: none"> 1. Check whether the AC cable is correctly connected. 2. Check whether the insulation between the ground cable and the live wire is normal. 3. If the fault still exists, contact SUNGROW.
051	Off-grid Load Overpower	<ol style="list-style-type: none"> 1. Reduce the power of loads connected at the off-grid port, or remove some loads. 2. If the alarm persists, contact SUNGROW.
714	BMS Communication Fault	<ol style="list-style-type: none"> 1. Check whether the communication cable and the terminals are abnormal. If so, correct them to ensure reliable connection. 2. Reconnect the communication cable of the meter. 3. If the fault still exists, contact SUNGROW.
932–935, 937, 939	Battery Alarm	<p>Generally, the battery can automatically recover. In case the alarm persist for a long time:</p> <ol style="list-style-type: none"> 1. If the alarm is caused by ambient temperature, such as over temperature alarm or low temperature alarm, take measures to change the ambient temperature, such as improving heat dissipation conditions. 2. If the fault persists, contact battery manufacturer.

Alarm ID	Alarm Name	Corrective Measures
703, 711, 712, 715, 732–736, 739, 832– 833, 835– 837	Battery Abnormal	<ol style="list-style-type: none"> 1. In case of abnormal battery voltage, check whether the battery power cable connection is abnormal (reverse connection, loose, etc.). If so, connect the battery power cable correctly. 2. Check whether the battery real-time voltage is abnormal if the battery power cable is correctly connected. If so, contact the battery manufacturer. If not, contact SUNGROW. 3. In case of abnormal battery temperature, take measures to change the ambient temperature, such as improving heat dissipation conditions. 4. If the fault persists, contact battery manufacturer.
502-504, 507, 508, 510, 513, 516–518	System Alarm	<ol style="list-style-type: none"> 1. The inverter can continue running. 2. Check whether the related wiring and terminal are abnormal, check whether there are any foreign materials or other environmental abnormalities, and take corresponding corrective measures when necessary. 3. If the alarm persists, please contact SUNGROW.
006, 007, 011, 019 , 021 , 025, 038, 040– 042, 048– 050, 052– 054, 056 , 064–067, 100–102, 105, 107, 113, 117, 200–205, 300 , 303– 305, 308– 316 , 320, 600 , 601, 605, 608, 612, 616, 620, 624	System Fault	<ol style="list-style-type: none"> 1. Wait for the inverter to return to normal. 2. Disconnect the AC and DC switches, and disconnect the battery side switches if there are batteries. Close the AC and DC switches in turn 15 minutes later and restart the system. 3. If the fault still exists, contact SUNGROW.



Contact the distributor if the measures listed in the “Troubleshooting Method” column have been taken but the problem persists. Contact SUNGROW if the distributor fails to solve the problem.

10.2 Maintenance

10.2.1 Maintenance Notices

The DC switch can be secured with a lock in the OFF position or a certain angle beyond the OFF position.(For countries “AU” and “NZ”)

DANGER

Risk of inverter damage or personal injury due to incorrect service!

- **Be sure to use special insulation tools when perform high-voltage operations.**
- **Before any service work, first disconnect the grid-side AC circuit breaker and check the inverter status. If the inverter indicator is off, please wait until night to disconnect the DC switch. If the inverter indicator is on, directly disconnect the DC switch.**
- **After the inverter is powered off for 10 minutes, measure the voltage and current with professional instrument. Only when there is no voltage nor current can operators who wear protective equipment operate and maintain the inverter**
- **Even if the inverter is shut down, it may still be hot and cause burns. Wear protective gloves before operating the inverter after it cools down.**
- **When maintaining the product, it is strictly prohibited to open the product if there is an odor or smoke or if the product appearance is abnormal. If there is no odor, smoke, or obvious abnormal appearance, repair or restart the inverter according to the alarm corrective measures. Avoid standing directly in front of the inverter during maintenance.**

CAUTION

To prevent misuse or accidents caused by unrelated personnel: Post prominent warning signs or demarcate safety warning areas around the inverter to prevent accidents caused by misuse.

NOTICE

Restart the inverter only after removing the fault that impairs safety performance. As the inverter contains no component parts that can be maintained, never open the enclosure, or replace any internal components.

To avoid the risk of electric shock, do not perform any other maintenance operations beyond those described in this manual. If necessary, contact your distributor first. If the problem persists, contact SUNGROW. Otherwise, the losses caused is not covered by the warranty.

NOTICE

Touching the PCB or other static sensitive components may cause damage to the device.

- **Do not touch the circuit board unnecessarily.**
- **Observe the regulations to protect against electrostatic and wear an anti-static wrist strap.**

10.2.2 Routine Maintenance

Item	Method	Period
General status of the system	<ul style="list-style-type: none"> • Visual check for any damage or deformation of the inverter. • Check any abnormal noise during the operation. • Check each operation parameter. • Be sure that nothing covers the heat sink of the inverter. 	Every 6 months
Electrical connection	Check whether there is damage to the cables, especially the surface in contact with metal.	6 months after commissioning and then once or twice a year

10.2.3 Replacing the Button Cell** DANGER**

Disconnect the inverter from the grid first, then the PV strings and the battery before any maintenance work.

Lethal voltage still exists in the inverter. Please wait at least 10 minutes and then perform maintenance work.

There is a button cell on the inner PCB board. Contact SUNGROW for replacement when the relevant fault alarm occurs.

Check the fastener, appearance, voltage, and resistance quarterly and annually.

11 Appendix

11.1 Technical Data

Parameters	SH5.0RT	SH6.0RT
PV Input		
Recommended max. PV input power	7500 W	9000 W
Max. PV input voltage	1000 V	1000 V
Startup voltage	180 V	250 V
Rated input voltage	600 V	600 V
MPP voltage range	150 V - 950 V	200 V - 950 V
MPP voltage range for rated power	210 V - 850 V	250 V - 850 V
No. of MPPTs	2	
Max. number of PV strings per MPPT	1 / 1	
Max. PV input current	25 A (12.5 A / 12.5 A)	
Max. current for input connector	30 A	
Short-circuit current of PV input	32 A (16 A / 16 A) for other countries 36 A (18 A / 18 A) for Australia	
Battery Data		
Battery type	Li-ion battery	
Battery voltage	150 V - 600 V	
Max. charge / discharge current	30 A * / 30 A *	
Max. charge / discharge power	7500 W / 6000 W	9000 W / 7200 W
AC Input and Output Data		
Rated AC output power	5000 W	6000 W
Rated AC output current	7.3 A	8.7 A
Max. AC input power from grid	12500 W	15000 W
Max. AC output power	5000 VA	6000 VA
Rated AC output apparent power	5000 VA	6000 VA

Parameters	SH5.0RT	SH6.0RT
Max. AC output current	7.6 A	9.1 A
Rated AC voltage	3 / N / PE, 220 / 380 V; 230 / 400 V; 240 / 415 V	
AC voltage range	270 - 480 Vac	
Rated grid frequency/Grid frequency range	50Hz / 45 - 55Hz, 60Hz / 55 - 65Hz	
THD	< 3 % (of rated power)	
DC current injection	< 0.5 % In	
Power factor	> 0.99 / 0.8 leading to 0.8 lagging	
Protection&Function		
LVRT	Yes	
Anti-islanding protection	Yes	
AC short circuit protection	Yes	
Leakage current protection	Yes	
DC switch (solar)	Yes	
DC Overcurrent Protection (battery)	Yes	
Over-voltage category	III [Mains], II [PV] [Battery]	
SPD	DC Type II / AC Type II	
Battery input reverse polarity protection	Yes	
Parallel operation on grid port / Max. No. of inverters	Master-slave mode / 5 ** (need same inverters type)	
Protective Class	I	
Overvoltage Category	DC II/AC III	
Active Anti-Islanding Method	Frequency Shift	
System Data		
Max. efficiency	98.0 %	98.2 %
European efficiency	97.2 %	97.5 %
Isolation method (solar / battery)	Transformerless / Transformerless	
Degree of protection	IP65	
Operating ambient temperature range	-25 °C - 60 °C	
Allowable relative humidity range (Non-condensing)	0 - 100 %	
Cooling method	Natural convection	
Max. operating altitude	4000 m (> 3000 m derating)	
Noise (Typical)	30 dB(A)	

Parameters	SH5.0RT	SH6.0RT
Display	LED	
Communication	RS485, WLAN, Ethernet, CAN, 4 × DI, 1 × DO	
DC connection type	MC4 (PV) / Sunclix (Battery)/Evo2 Compatible (Battery)	
AC connection type	Plug and play connector	
Country of manufacture	China	
Mechanical Data		
Dimensions (W x H x D)	460 mm x 540 mm x 170 mm	
Mounting method	Wall-mounting bracket	
Weight	27 kg	
Backup Data		
Rated voltage	3 / N / PE, 220 Vac / 230 Vac / 240 Vac	
Frequency range	50 Hz / 60 Hz	
Total harmonic factor output voltage(Linear load)	2%	
Switch time to emergency mode	< 20 ms	
Rated output power	5000 W / 5000 VA	6000 W / 6000 VA
Peak output power ***	6000 W / 6000 VA , 5min	7200 W / 7200 VA,5min
	10000 W / 10000 VA , 10 s	10000 W / 10000 VA,10 s
Peak output power on single phase ****	2000 VA (≥9.6kWh)	2200 VA (≥128kWh)
Rated output current for backup load during on grid mode	3 x 18.5 A	

* Depending on the connected battery.

** Germany is available for 2 inverters parallel in maximum if no ripple control is used in system.

*** Can be reached only if PV and battery power is sufficient. Detail compatibility for backup under off-grid scenario can be referred to the user manual.

**** Peak power only for Resistive loads. Detail refer to SHRT backup output power document.

Parameters	SH8.0RT	SH10RT
PV Input		
Recommended max. PV input power	12000 W	15000 W
Max. PV input voltage	1000 V	
Startup voltage	250 V	
Rated input voltage	600 V	

Parameters	SH8.0RT	SH10RT
MPP voltage range	200 V - 950 V	
MPP voltage range for rated power	330 V - 850 V	280 V - 850 V
No. of MPPTs	2	
Max. number of PV strings per MPPT	1 / 1	1 / 2
Max. PV input current	25 A (12.5 A / 12.5 A)	37.5 A (12.5 A / 25 A)
Max. current for input connector	30 A	
Short-circuit current of PV input	32 A (16 A / 16 A) for other countries 36 A (18 A / 18 A) for Australia	48 A (16 A / 32 A) for other countries 54 A (18 A / 36 A) for Australia
Battery Data		
Battery type	Li-ion battery	
Battery voltage	150 V - 600 V	
Max. charge / discharge current	30 A * / 30 A *	
Max. charge / discharge power	10600 W / 10600 W	
AC Input and Output Data		
Rated AC output power	8000 W	10000 W 9999 W for Australia
Rated AC output current	11.6 A	14.5 A
Max.AC input power from grid	18600 W	20600 W
Max. AC output power	8000VA	10000VA 9999VA for Australia
Rated AC output apparent power	8000 VA	10000 VA 9999VA for Australia
Max. AC output current	12.1 A	15.2 A
Rated AC voltage	3 / N / PE, 220 / 380 V; 230 / 400 V; 240 / 415 V	
AC voltage range	270 - 480 Vac	
Rated grid frequency/Grid frequency range	50Hz / 45 - 55Hz, 60Hz / 55 - 65Hz	
THD	< 3 % (of rated power)	
DC current injection	< 0.5 % I _n	
Power factor	> 0.99 / 0.8 leading to 0.8 lagging	

Parameters	SH8.0RT	SH10RT
Protection&Function		
LVRT		Yes
Anti-islanding protection		Yes
AC short circuit protection		Yes
Leakage current protection		Yes
DC switch (solar)		Yes
DC Overcurrent Protection (battery)		Yes
Over-voltage category	III [Mains], II [PV] [Battery]	
SPD	DC Type II / AC Type II	
Battery input reverse polarity protection		Yes
Parallel operation on grid port / Max. No. of inverters	Master-slave mode / 5 ** (need same inverters type)	
Protective Class	I	
Overvoltage Category	DC II/AC III	
Active Anti-Islanding Method	Frequency Shift	
System Data		
Max. efficiency	98.4 %	98.4 %
European efficiency	97.9 %	97.9 %
Isolation method (solar / battery)	Transformerless / Transformerless	
Degree of protection	IP65	
Operating ambient temperature range	-25 °C - 60 °C	
Allowable relative humidity range (non-condensing)	0 - 100 %	
Cooling method	Natural convection	
Max. operating altitude	4000 m (> 3000 m derating)	
Noise (Typical)	30 dB(A)	
Display	LED	
Communication	RS485, WLAN, Ethernet, CAN, 4 × DI, 1 × DO	
DC connection type	MC4 (PV) / Sunclix (Battery)/Evo2 Compatible (Battery)	
AC connection type	Plug and play connector	
Country of manufacture	China	
Mechanical Data		
Dimensions (W x H x D)	460 mm x 540 mm x 170 mm	
Mounting method	Wall-mounting bracket	

Parameters	SH8.0RT	SH10RT
Weight	27 kg	
Backup Data		
Rated voltage	3 / N / PE, 220 Vac / 230 Vac / 240 Vac	
Frequency range	50 Hz / 60 Hz	
Total harmonic factor output voltage(Linear load)	2%	
Switch time to emergency mode	< 20 ms	
Rated output power	8000 W / 8000 VA	10000 W / 10000 VA 9999 W / 9999 VA for Australia
Peak output power ***	12000 W / 12000 VA,5min	
Peak output power on single phase ****	2700 VA (≥128kWh)	3400 VA (≥128kWh)
Rated output current for backup load during on grid mode	3 x 18.5 A	

* Depending on the connected battery.

** Germany is available for 2 inverters parallel in maximum if no ripple control is used in system.

*** Can be reached only if PV and battery power is sufficient.Detail compatibility for backup under off-grid scenario can be referred to the user manual.

**** Peak power only for Resistive loads. Detail refer to SHRT backup output power document.

Parameters	SH5.0RT-20	SH6.0RT-20
PV Input		
Recommended max. PV input power	7500 W	9000 W
Max. PV input voltage	1000 V	1000 V
Min. PV input voltage / Start-up voltage	150 V / 180 V	200 V / 250 V
Rated input voltage	600 V	600 V
MPP voltage range	150 V - 950 V	200 V - 950 V
MPP voltage range for rated power	210 V - 850 V	250 V - 850 V
No. of MPPTs	2	
Max. number of PV strings per MPPT	1 / 1	

Parameters	SH5.0RT-20	SH6.0RT-20
Max. PV input current	27 A (13.5 A / 13.5 A)	
Max. current for input connector	30 A	
Short-circuit current of PV input	36 A (18 A / 18 A)	
Battery Data		
Battery type	Lithium battery	
Battery voltage	150 V - 600 V	
Max. charge / discharge current	30 A * / 30 A *	
Max. charge / discharge power	7500 W / 6000 W	9000 W / 7200 W
AC Input and Output Data		
Max. AC input power to battery	11600W	14000W
Max. AC input power from grid	12500 W	15000 W
Rated AC output power	5000 W	6000 W
Rated AC output apparent power	5000 VA	6000 VA
Rated AC output current	7.6 A	9.1 A
Rated AC voltage	3 / N / PE, 220 / 380 V; 230 / 400 V; 240 / 415 V	
AC voltage range	270 - 480 Vac	
Rated grid frequency	50Hz	
Grid frequency range	45 – 55Hz	
Harmonic THD	< 3 % (of rated power)	
DC current injection	< 0.5 % In	
Power factor at Rated power / Adjustable power factor	> 0.99 / 0.8 leading to 0.8 lagging	
Feed-in phases/connection phases	3 / 3	
Protection&Function		
Grid monitoring	Yes	
Anti-islanding protection	Yes	
DC reverse polarity protection	Yes	
DC switch (solar)	Yes	

Parameters	SH5.0RT-20	SH6.0RT-20
DC Overcurrent Protection (battery)		Yes
Surge Protection		DC Type II / AC Type II
Parallel operation on grid port / Max. No. of inverters		Master-slave mode / 5 **
Battery input reverse polarity protection		Yes
Protective Class		I
Overvoltage Category		DC II/AC III
Active Anti-Islanding Method		Frequency Shift
System Data		
Max. efficiency	98.0 %	98.2 %
European efficiency	97.2 %	97.5 %
Topology (solar / battery)	Transformerless / Transformerless	
Degree of protection	IP65	
Operating ambient temperature range	-25 °C - 60 °C	
Allowable relative humidity range (Non-condensing)	0 - 100 %	
Cooling method	Natural convection	
Max. operating altitude	4000 m	
Noise (Typical)	30 dB(A)	
Display	LED	
Communication	RS485, WLAN, Ethernet, CAN, 4 × DI, 1 × DO	
DC connection type	MC4 (PV) / Evo2 Compatible (Battery)	
AC connection type	Plug and play connector	
Country of manufacture	China	
Mechanical Data		
Dimensions (W x H x D)	460 mm x 540 mm x 170 mm	
Mounting method	Wall-mounting bracket	
Weight	27 kg	
Backup Data		
Rated voltage	3 / N / PE, 220 Vac / 230 Vac / 240 Vac	
Frequency range	50 Hz / 60 Hz	
Total harmonic factor output voltage (Linear load)	2%	
Switch time to emergency mode	< 20 ms	

Parameters	SH5.0RT-20	SH6.0RT-20
Rated output power	5000 W / 5000 VA	6000 W / 6000 VA
Peak output power ***	6000 W / 6000 VA , 5min 10000 W / 10000 VA , 10 s	7200 W / 7200 VA,5min 10000 W / 10000 VA,10 s
Peak output power on single phase ****	2000 VA (≥9.6kWh)	2200 VA (≥12.8kWh)
Rated output current for backup load during on grid mode	3 x 18.5 A	

* Depending on the connected battery.

** Germany is available for 2 inverters parallel in maximum if no ripple control is used in system.

*** Can be reached only if PV and battery power is sufficient. Detail compatibility for backup under off-grid scenario can be referred to the user manual.

**** Peak power only for Resistive loads. Detail refer to SHRT backup output power document.

Parameters	SH8.0RT-20	SH10RT-20
PV Input		
Recommended max. PV input power	12000 W	15000 W
Max. PV input voltage	1000 V	1000 V
Min. PV input voltage / Start-up voltage	200 V / 250 V	200 V / 250 V
Rated input voltage	600 V	600 V
MPP voltage range	200 V - 950 V	200 V - 950 V
MPP voltage range for rated power	330 V - 850 V	280 V - 850 V
No. of MPPTs	2	
Max. number of PV strings per MPPT	1 / 1	
Max. PV input current	27 A (13.5 A / 13.5 A)	
Max. current for input connector	30 A	
Short-circuit current of PV input	36 A (18 A / 18 A)	54 A (18 A / 36 A)
Battery Data		
Battery type	Lithium battery	
Battery voltage	150 V - 600 V	

Parameters	SH8.0RT-20	SH10RT-20
Max. charge / discharge current	30 A * / 30 A *	
Max. charge / discharge power	10600 W / 10600 W	10600 W / 10600 W
AC Input and Output Data		
Max. AC input power to battery	18600 W	20600 W
Max. AC input power from grid	18600 W	20600 W
Rated AC output power	8000 W	10000 W 9999W for Australia
Rated AC output apparent power	8000 VA	10000 VA 9999W for Australia
Rated AC output current	12.1 A	15.2 A
Rated AC voltage	3 / N / PE, 220 / 380 V; 230 / 400 V; 240 / 415 V	
AC voltage range	270 - 480 Vac	
Rated grid frequency	50Hz	
Grid frequency range	45 – 55Hz	
Harmonic THD	< 3 % (of rated power)	
DC current injection	< 0.5 % In	
Power factor at Rated power / Adjustable power factor	> 0.99 / 0.8 leading to 0.8 lagging	
Feed-in phases/connection phases	3 / 3	
Protection&Function		
Grid monitoring	Yes	
Anti-islanding protection	Yes	
DC reverse polarity protection	Yes	
DC switch (solar)	Yes	
DC Overcurrent Protection (battery)	Yes	
Surge Protection	DC Type II / AC Type II	
Parallel operation on grid port / Max. No. of inverters	Master-slave mode / 5 **	
Battery input reverse polarity protection	Yes	

Parameters	SH8.0RT-20	SH10RT-20
Protective Class	I	
Overvoltage Category	DC II/AC III	
Active Anti-Islanding Method	Frequency Shift	
System Data		
Max. efficiency	98.4 %	98.4 %
European efficiency	97.9 %	97.9 %
Topology (solar / battery)	Transformerless / Transformerless	
Degree of protection	IP65	
Operating ambient temperature range	-25 °C - 60 °C	
Allowable relative humidity range (Non-condensing)	0 - 100 %	
Cooling method	Natural convection	
Max. operating altitude	4000 m	
Noise (Typical)	30 dB(A)	
Display	LED	
Communication	RS485, WLAN, Ethernet, CAN, 4 × DI, 1 × DO	
DC connection type	MC4 (PV) / Evo2 Compatible (Battery)	
AC connection type	Plug and play connector	
Country of manufacture	China	
Mechanical Data		
Dimensions (W x H x D)	460 mm x 540 mm x 170 mm	
Mounting method	Wall-mounting bracket	
Weight	27 kg	
Backup Data		
Rated voltage	3 / N / PE, 220 Vac / 230 Vac / 240 Vac	
Frequency range	50 Hz / 60 Hz	
Total harmonic factor output voltage(Linear load)	2%	
Switch time to emergency mode	< 20 ms	
Rated output power	8000 W / 8000 VA	10000 W / 10000 VA 9999 W / 9999 VA for Australia
Peak output power ***	12000 W / 12000 VA , 5min	12000 W / 12000 VA,5min

Parameters	SH8.0RT-20	SH10RT-20
Peak output power on single phase ****	2700 VA ($\geq 12.8\text{kWh}$)	3400 VA ($\geq 12.8\text{kWh}$)
Rated output current for backup load during on grid mode	3 x 18.5 A	

* Depending on the connected battery.

** Germany is available for 2 inverters parallel in maximum if no ripple control is used in system.

*** Can be reached only if PV and battery power is sufficient. Detail compatibility for backup under off-grid scenario can be referred to the user manual.

**** Peak power only for Resistive loads. Detail refer to SHRT backup output power document.

11.2 The Compatibility for Backup under Off-grid Scenario

The information below is about the compatibility for backup of SUNGROW SH5.0–10RT / SH5.0–10RT-20 inverter under off-grid scenario. Please refer to this information before you use the back-up model of the four inverters under off-grid situation.

Main electrical panel

Type	Load Power			
	SH5.0RT/ SH5.0RT-20	SH6.0RT/ SH6.0RT-20	SH8.0RT/ SH8.0RT-20	SH10RT/ SH10RT-20
Dust collector	1 kW	1 kW	1 kW	1.3 kW
Water heater / Kettle / Iron / Oven / Toaster / Geothermal blanket / Rice cooker	1.5 kW	1.8 kW	2.4 kW	3 kW (2.5 kW with SBR096)
Microwave oven	1 kW	1 kW	1.3 kW	1.5 kW
Refrigerator	1 kW	1 kW	1 kW	1 kW
TV / Computer	1 kW	1 kW	1 kW	1 kW
Bath heater	1 kW	1.5 kW	2 kW	2.5 kW
Fluorescent / LED lights	1 kW	1 kW	1 kW	1.3 kW
Electric fan / Ceiling fan	1 kW	1.2 kW	1.6 kW	2 kW

Additional large appliances

Type	SH5.0RT/ SH5.0RT-20	SH6.0RT/ SH6.0RT-20	SH8.0RT/ SH8.0RT-20	SH10RT/ SH10RT-20
Conditioner (Frequency conversion)	1P	1P	1P	1.5P



The data of the compatibility for backup of SH5.0–10RT / SH5.0–10RT-20 are based on the test with SUNGROW SBR096/128/160/192/224/256 batteries (-20 ~ 53 °C, 5~100% SOC). For the actual application, please refer to the maximum output capacity of the battery used.

For those loads that not covered in this document, please contact SUNGROW to make sure the compatibility of the specific loads under off-grid scenario. SUNGROW will not be held responsible for the usage of any load without confirmation. We will keep updating this document, please contact SUNGROW if there are any relevant issues.

11.3 Quality Assurance

When product faults occur during the warranty period, SUNGROW will provide free service or replace the product with a new one.

Evidence

During the warranty period, the customer shall provide the product purchase invoice and date. In addition, the trademark on the product shall be undamaged and legible. Otherwise, SUNGROW has the right to refuse to honor the quality guarantee.

Conditions

- After replacement, unqualified products shall be processed by SUNGROW.
- The customer shall give SUNGROW a reasonable period to repair the faulty device.

Exclusion of Liability

In the following circumstances, SUNGROW has the right to refuse to honor the quality guarantee:

- The free warranty period for the whole machine/components has expired.
- The device is damaged during transport.
- The device is incorrectly installed, refitted, or used.
- The device operates in harsh conditions beyond those described in this manual.
- The fault or damage is caused by installation, repairs, modification, or disassembly performed by a service provider or personnel not from SUNGROW.
- The fault or damage is caused by the use of non-standard or non-SUNGROW components or software.

- The installation and use range are beyond stipulations of relevant international standards.
- The damage is caused by unexpected natural factors.

For faulty products in any of above cases, if the customer requests maintenance, paid maintenance service may be provided based on the judgment of SUNGROW.

11.4 Contact Information

In case of questions about this product, please contact us.

We need the following information to provide you the best assistance:

- Model of the device
- Serial number of the device
- Fault code/name
- Brief description of the problem

For detailed contact information, please visit: <https://en.sungrowpower.com/contactUS>