

User Manual

Home Energy Manager

iHomeManager

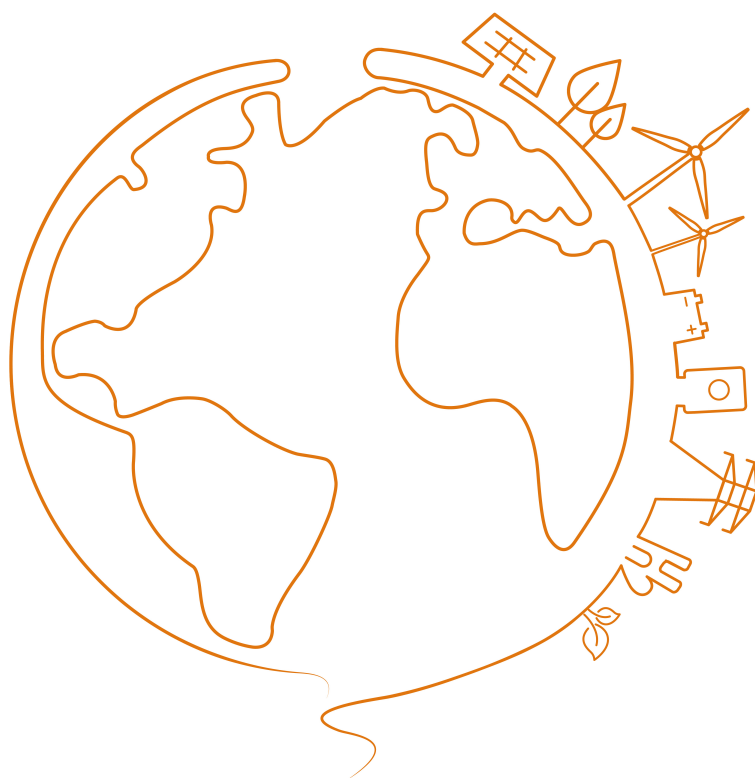

All Rights Reserved

All Rights Reserved

No part of this document can be reproduced in any form or by any means without the prior written permission of Sungrow Power Supply Co., Ltd (hereinafter "SUNGROW").

Trademark

SUNGROW and other Sungrow trademarks used in this manual are owned by SUNGROW. All other trademarks or registered trademarks mentioned in this manual are owned by their respective owners.

Software Licenses

- It is prohibited to use data contained in firmware or software developed by SUNGROW, in part or in full, for commercial purposes by any means.
- It is prohibited to perform reverse engineering, cracking, or any other operations that compromise the original program design of the software developed by SUNGROW.

Contents

- All Rights Reserved..... I
- 1 About This Manual**..... 1
- 2 Revision History**.....3
- 3 Safety Instructions**.....4
 - 3.1 Understanding Safety Signs..... 4
 - 3.2 General Safety Instructions..... 4
 - 3.3 Packaging, Transportation, and Storage Safety..... 6
 - 3.4 Installation Safety..... 7
 - 3.5 Electrical Connection Safety.....7
 - 3.6 Operation and Maintenance Safety..... 8
 - 3.7 Disposal Safety.....9
- 4 Product Overview**..... 11
 - 4.1 About iHomeManager..... 11
 - 4.2 Application Scenarios..... 12
 - 4.3 External Design..... 17
- 5 Unpacking and Storage**..... 19
 - 5.1 Scope of Delivery.....19
 - 5.2 Unpacking and Inspection..... 20
 - 5.3 Nameplate..... 20
 - 5.4 Storage Requirements.....21
- 6 Mechanical Mounting**.....23
 - 6.1 Installation Requirements..... 23
 - 6.2 Installation Tools..... 23
 - 6.3 Installation Methods.....24
 - 6.3.1 Mounted on a Wall..... 24
 - 6.3.2 Mounted on a Guide Rail..... 27
 - 6.4 Antenna Installation.....28
- 7 Electrical Connection**.....30
 - 7.1 Wiring Notice..... 30
 - 7.2 Terminal Description..... 30
 - 7.3 Cable Requirements..... 33
 - 7.4 Power Supply and CT Connection.....34
 - 7.5 Inverter Connection via RS485.....36
 - 7.6 (Optional) CT Connection for Third-Party Inverter.....38

7.7 Heat Pump Connection via DO.....	39
7.8 Router Connection.....	41
7.9 DI Connection.....	41
8 Commissioning.....	44
8.1 Inspection Before Powering on.....	44
8.2 Power-on Process.....	45
9 iHomeManager Configuration with iSolarCloud.....	46
9.1 About iSolarCloud App.....	46
9.2 Preparation.....	46
9.2.1 Install iSolarCloud.....	46
9.2.2 Local Access.....	47
9.3 App Overview.....	49
9.4 Quick Setting.....	51
9.4.1 Network Configuration.....	52
9.4.2 Device Management.....	56
9.4.3 Parameter Settings.....	59
9.4.4 System Self-test.....	60
9.4.5 Create Plant.....	61
9.4.6 View Plant Information.....	63
9.4.7 View Device Information.....	63
9.5 EV Charger Settings (Optional)(Optional).....	63
9.5.1 ECO Charging.....	65
9.5.2 Fast Charging.....	67
9.5.3 Scheduled Charging.....	69
9.5.4 Customized Charging.....	71
9.6 Energy Management by iHomeManager.....	73
9.6.1 Self-Consumption.....	74
9.6.1.1 Demand Control.....	75
9.6.1.2 Custom Month Span.....	77
9.6.2 Time Plan.....	78
9.6.3 Forced Mode.....	80
9.6.4 AI Mode.....	81
9.6.4.1 Maximize Revenue.....	83
9.6.4.2 Maximize PV Energy Usage.....	83
9.6.4.3 View Energy Analysis Curve Results.....	83
9.7 Power Control.....	85
9.7.1 DI Power Regulation.....	85
9.7.1.1 Ripple Control.....	85
9.7.1.2 Control via EnWG 14a.....	87
9.7.1.3 Emergency Stop Function.....	87

9.7.2 Grid-Connected Power Control.....	88
9.8 Intelligent Load.....	90
9.8.1 Scheduled Mode (Heat Pump Control).....	90
9.8.2 Instant Mode (Heat Pump Control).....	92
9.8.3 ECO Mode (Heat Pump Control).....	92
9.9 Device Settings.....	94
9.9.1 iHomeManager Settings.....	94
9.9.2 Inverter Grid-connection Settings.....	97
9.10 Device List.....	97
9.10.1 Add Device.....	99
9.10.2 Add Third-Party Device.....	101
9.10.2.1 Add Shelly Smart Plug.....	101
9.10.2.2 Add Shelly Relay.....	106
9.10.2.3 Add EEBUS Heat Pump.....	114
9.10.3 Delete Device.....	121
9.11 Other Functions.....	122
9.11.1 Firmware Update.....	122
9.11.2 Download Logs.....	122
9.11.3 Network Configuration.....	123
9.11.4 Server Settings.....	123
9.11.5 Certificate Management.....	124
9.11.6 Communication Settings.....	127
9.11.7 User Management.....	128
9.11.7.1 Change Account Password.....	128
9.11.7.2 Logout.....	128
10 Troubleshooting.....	130
10.1 Fault List.....	130
10.2 Fault Description.....	130
10.3 FAQs.....	131
11 Maintenance.....	133
11.1 Maintenance Notices.....	133
11.2 Routine Maintenance.....	134
12 Appendix.....	136
12.1 Technical Data.....	136
12.2 Quality Assurance.....	137
12.3 Contact Information.....	138

1 About This Manual

The manual mainly contains the product information, as well as guidelines for installation, operation, and maintenance. The manual does not include complete information about the photovoltaic (PV) system. Readers can get additional information at www.sungrowpower.com or on the webpage of the respective component manufacturer.

Validity

This manual is valid for the following models:

- iHomeManager

Type Description

Type	Product Aliases	Communication Manner
iHomeManager	Home Energy Manager, device, product	Supports WLAN, ETH, RS485, DI, and DO

Target Group

This manual is intended for professional technicians who are responsible for installation, operation, and maintenance of inverters, and users who need to check inverter parameters.

The product must only be installed by professional technicians. The professional technician is required to meet the following requirements:

- Know electronic, electrical wiring and mechanical expertise, and be familiar with electrical and mechanical schematics.
- Have received professional training related to the installation and commissioning of electrical equipment.
- Be able to quickly respond to hazards or emergencies that occur during installation and commissioning.
- Be familiar with local standards and relevant safety regulations of electrical systems.
- Read this manual thoroughly and understand the safety instructions related to operations.

How to Use This Manual

Please read this manual carefully before using the product and keep it properly at a place for easy access.

All contents, pictures, marks, and symbols in this manual are owned by SUNGROW. No part of this document may be reprinted by the non-internal staff of SUNGROW without written authorization.

Contents of this manual may be periodically updated or revised, and the actual product purchased shall prevail. Users can obtain the latest manual from support.sungrowpower.com or sales channels.

Security Declaration

For details on the product's network security vulnerability response process and vulnerability disclosure, please visit the following website: <https://en.sungrowpower.com/security-vulnerability-management>.

Symbols

This manual contains important safety instructions, which are highlighted with the following symbols, to ensure personal and property safety during usage, or to help optimize the product performance in an efficient way.

Please carefully understand the meaning of these warning symbols to better use the manual.

DANGER

Indicates high-risk potential hazards that, if not avoided, may lead to death or serious injury.

WARNING

Indicates moderate-risk potential hazards that, if not avoided, may lead to death or serious injury.

CAUTION

Indicates low-risk potential hazards that, if not avoided, may lead to minor or moderate injury.

NOTICE

Indicates potential risks that, if not avoided, may lead to device malfunctions or financial losses.



“NOTE” indicates additional information, emphasized contents or tips that may be helpful, e.g., to help you solve problems or save time.

2 Revision History

The revision history lists the major updates for each software version in the document. The latest version includes all updates from previous versions.

Date	Software Version	Changes
2026-01	iHomeManager-SV930.001.00.P014	<ul style="list-style-type: none">Added: 9.11.6 Communication SettingsUpdated: 9.7.2 Grid-Connected Power Control
2025-12	iHomeManager-SV930.001.00.P013	<ul style="list-style-type: none">Added: 9.10.2 Add Third-Party DeviceUpdated: 9.5 EV Charger Settings (Optional) (Optional)

3 Safety Instructions

When installing, commissioning, operating, and maintaining the product, strictly observe relevant safety instructions. Improper use or misoperation may result in:

- Injury or death to the operator or a third party.
- Damage to the product or the property of the operator or a third party.

Strictly follow the safety instructions stated in the manual to avoid the hazards mentioned above.



- The safety instructions in this manual are only supplements and cannot cover all the precautions that should be followed. Perform operations considering actual on-site conditions.
- SUNGROW shall not be held liable for any damage caused by violation of general safety operation requirements, general safety standards, or any safety instruction in this manual.
- When installing, operating, and maintaining the device, comply with local laws and regulations. The safety precautions in this manual are only supplements to local laws and regulations.

3.1 Understanding Safety Signs

Symbol	Description
	Read the instructions before performing any operations on the product.
	Do not dispose of the equipment as household waste.

3.2 General Safety Instructions

Regulatory Requirements

- All operations related to the product must comply with relevant laws and regulations of the country or region.
- Obtain permission from the local power department before grid-connected operation.

- Ensure all safety labels on the product remain clear and visible throughout the entire product life cycle. Do not remove, paint over, block or damage any labels or nameplates on the product.
- Ensure that the materials used comply with relevant environmental protection and health and safety standards.
- Take appropriate fire safety measures in accordance with applicable fire safety requirements, such as using flame-retardant materials and installing fire alarm systems.

Personnel Requirements

⚠ DANGER

Operators are strictly prohibited from wearing watches, rings, necklaces or other conductive items, which may cause electric shock burns.

⚠ WARNING

If any condition or malfunction that may endanger personal safety or damage equipment is found during operations related to the product, stop operations immediately and do not continue using the product.

- Only trained and authorized personnel may operate and maintain the product.
- Operators must understand the correct use of tools and be familiar with all safety precautions mentioned in this manual.
- All operations related to the product must be performed by qualified personnel wearing personal protective equipment.
- All equipment and tools used during product operation and maintenance must be inspected regularly.

Environmental Requirements

⚠ DANGER

Do not use or place the product in flammable, explosive or corrosive gas environments.

⚠ WARNING

Do not operate the product in severe weather such as thunderstorms, rain, snow, Level 6 or stronger winds, including but not limited to transportation, installation, electrical connection, power-on, maintenance and high-altitude operations.

⚠ WARNING

In case of fire, evacuate the building or product area and call the fire department. Do not re-enter the burning area.

NOTICE

Dust and moisture may damage the product!

- **Take appropriate measures such as keeping the product clean and dry if installation or electrical connection needs to be interrupted.**
- Ensure there are no heat sources or flames near the product to prevent overheating or malfunctions.
- Ensure there are no obstructions around the product, maintaining enough ventilation and heat dissipation space.
- Ensure there are no liquids around the product and it is far from areas where liquids may be present to avoid risks of short circuits and electrical faults.
- Avoid using equipment in environments with smoke, dust or other particulate matter.
- Ensure that the product does not interfere with other devices or is affected by interference when operating in an electromagnetic field environment.
- Ensure the working environment temperature and humidity for the product are within specified ranges.

3.3 Packaging, Transportation, and Storage Safety

⚠ CAUTION

Improper handling may cause personal injury!

- **When manually handling the product, the operator must wear personal protective equipment.**
- **When handling the product, consider its weight and keep the balance to prevent it from tilting or falling.**

NOTICE

Improper transportation may cause personal injury or product damage!

- **Select suitable transportation tools based on the product dimensions and weight.**
- **Products should be placed horizontally during transportation, with suitable packaging materials to fix the product in place or prevent impact.**
- **Avoid collisions or severe vibrations during transportation.**

NOTICE

Improper storage may cause product damage!

- **Do not store the product without packaging.**
- **Do not store the product outdoors or in direct sunlight.**

NOTICE

Products stored for over six months should undergo strict protection and necessary inspections. If necessary, install the product only after it has been tested by qualified personnel.

3.4 Installation Safety

⚠ DANGER

Improper installation may cause fire hazards!

- Make sure the product has no electrical connections before installation.
- Prevent foreign objects from entering the interior of the product during installation.

⚠ WARNING

Modification of the product without authorization is strictly prohibited. Unauthorized modifications may lead to serious safety risks, damage product performance, and even cause personal injury.

⚠ CAUTION

When wall drilling is required during installation, ensure that there are no electric cables and water pipes in the wall.

NOTICE

Keep the installation area clean.

- Clean up materials and tools used after product installation.
- Clean empty packaging materials such as cardboard boxes, foam, plastic and zip ties in the operation area.

3.5 Electrical Connection Safety

⚠ DANGER

Before electrical connections, please make sure that the product is not damaged. Otherwise, it may cause danger!

Before electrical connections, please make sure that the product switch and all switches connected to the product are set to "OFF", otherwise electric shock may occur!

⚠ DANGER

- Be sure to use special insulation tools during cable connections.
- Note and observe the warning labels on the product, and perform operations strictly following the safety instructions.
- Respect all safety precautions listed in this manual and other pertinent documents.

⚠ WARNING

Damage to the product caused by incorrect wiring is not covered by the warranty.

- Electrical connection must be performed by professionals.
- Check the power cord and confirm that the identifier is correct before connecting it.
- All cables used shall comply with the requirements of local laws and regulations, and must be firmly attached, properly insulated, and adequately dimensioned.

NOTICE

Comply with the regulations related to the local grid during wiring.

3.6 Operation and Maintenance Safety

⚠ DANGER

High voltage exists during product operation, and improper operation may endanger personal safety or damage the product!

- Do not touch the enclosure, as there may be risks of electric shock.
- Do not touch energized components, as there may be risks of electric shock.
- Do not touch hot components, as there may be risks of burns.
- Do not dismantle any parts of the product, as there may be risks of electric shock.

⚠ DANGER

Damaged product or system failures may cause electric shock or fire!

- Visually inspect the product for damage or other hazards before troubleshooting.
- Ensure all connections are secure.

⚠ DANGER

Improper maintenance may cause personal injury or product damage!

- Before maintenance, switch off all power connections to the product, including internal power supply.
- Ensure the product will not be powered on accidentally.
- Maintenance must be performed by qualified personnel wearing protective equipment and ensuring there are no voltage or current.
- Place prominent warning signs or safety tape around the area to prevent unauthorized access or accidents.
- If there are parts in the operation area that may carry voltage, cover them with insulated cloth for insulation shielding.

⚠ WARNING

Improper maintenance may cause personal injury or product damage!

- Check the warning labels on the enclosure and follow label requirements.
- Confirm that the product, associated external devices, or circuit connections are safe.
- For products that have been powered off for an extended period, a comprehensive inspection must be carried out before powering on, and they can only be put back into use after being checked and tested by qualified personnel.

3.7 Disposal Safety

⚠ CAUTION

Disposed products may contain hazardous substances or potential hazards!

- When disposing of products, comply with local, national, and international regulations and standards.
- During the transportation, storage, and disposal of discarded products, ensure proper measures are taken to prevent the leakage and contamination of hazardous substances, protecting soil, water sources, and air quality.
- Ensure that operators have the necessary training and personal protective equipment, and follow safety procedures. If necessary, entrust a professional team to handle the disposal of products.

NOTICE

Before disposing of products, ensure proper measures are taken to protect data security during the disposal process. This includes using methods such as data erasure, destruction, or encryption to prevent sensitive information from being leaked or misused.

NOTICE

Before disposing of products, ensure safety markings, warning labels, and nameplates are clearly visible.

4 Product Overview

4.1 About iHomeManager

The iHomeManager is a smart home energy management device capable of forecasting the PV plant's energy production and analyzing the load profile. It helps users to optimize energy usage based on local electricity prices, thus maximizing clean energy utilization and lowering electricity expenses. Additionally, it can store energy automatically in advance of severe weather and serve as a backup power source for users.

The iHomeManager can also be accessed to cloud. It can upload the collected data to the iSolarCloud so that users can easily view and monitor the operating status of devices attached to it in real time. Besides, it allows users to set the parameters for the attached devices and offers other functions such as log export, and power control.

Key Features

- Easy Installation
 - Allows wired or wireless network connection for easier communication;
 - Equipped with smart metering capabilities, requiring no additional power supply or RS485 communication wiring for an external energy meter.



The iHomeManager is not an energy meter for power consumption in the sense of the EU directive 2004/22/EG (MID). The iHomeManager may not be used for billing purposes. The data collected by the iHomeManager relating to the power generated by your PV system may deviate from the data of the main energy meter, which is used for billing purposes.

- Easy networking
 - Supports RS485, Ethernet, and WLAN communications;
 - Supports networking with the charger, battery, and multiple inverters.
- Easy O&M
 - Intelligent AI-based scheduling helps to increase clean energy usage and lower electricity cost;
 - Intelligent prediction enables the battery to charge in advance automatically ahead of severe weather, thus eliminating the concerns of power outages;
 - Energy management is made simpler with real-time yield tracking and at-a-glance consumption analysis.

4.2 Application Scenarios

NOTICE

- Establishing a network connection using both the RS485 communication and the WiNet communication module is not supported.
- By default, the iHomeManager communicates with the WiNet-S2 or the EV charger via Modbus TCP Port 516, with the port secured using SSL encryption.
- All communication devices need to be connected to the same home router. Only one iHomeManager is supported to be connected under a home router. To ensure stable communication between devices, all communication devices and the home router should be installed on the same layer. For devices not on the same layer, an Ethernet cable should be added for connection.

Residential PV-ESS-EV charging system (WiNet)

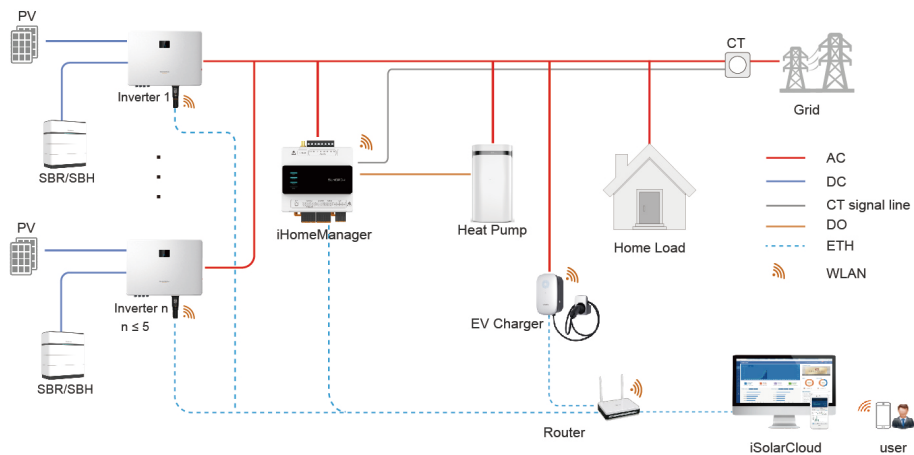

In this scenario, the iHomeManager communicates with the inverter via WiNet, thereby simplifying the wiring process.

The compatible devices are listed below.

Inverter	Battery RACK	Charger
SH5.0~10RT-20	SBR	AC22E-01
SH5.0~10RT	SBH	
SH5-25T		
SH3.0~6.0RS	SBR	
	SBS	

Residential PV-ESS-EV charging system (RS485)

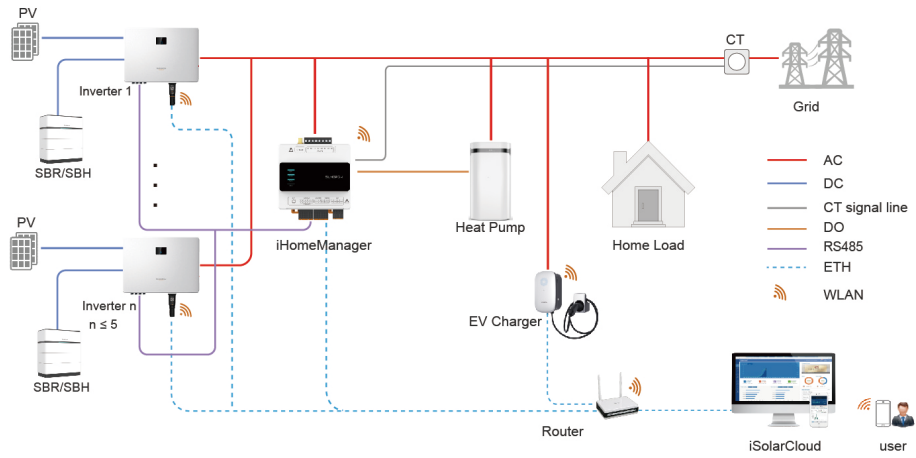

In this scenario, the iHomeManager communicates with the inverters and the inverters communicate with each other over RS485. The maximum distance for RS485 wiring is 1000m (baud rate: 9600bps). The inverter can only be connected via RS485 if the feed-in power limitation function is required.

The compatible devices are listed below.

Inverter	Battery RACK	Charger
SH5.0~10RT-20	SBR	AC22E-01
SH5.0~10RT	SBH	
SH5-25T		
SH3.0~6.0RS	SBR	
	SBS	

Retrofit system with third-party inverter (WiNet)

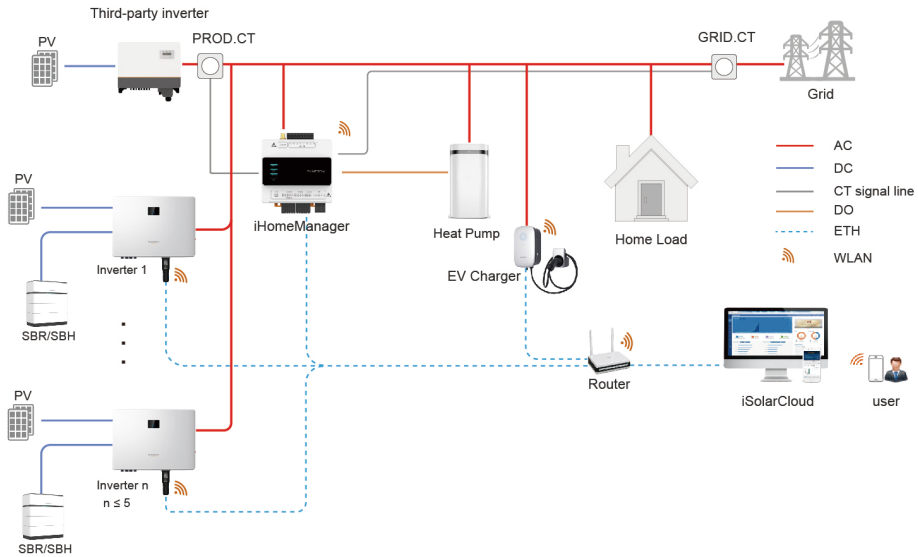

The compatible devices are listed below.

Inverter	Battery RACK	Charger
SH5.0~10RT-20	SBR	AC22E-01
SH5.0~10RT	SBH	
SH5-25T		
SH3.0~6.0RS	SBR	
	SBS	

Retrofit system with third-party inverter (RS485)

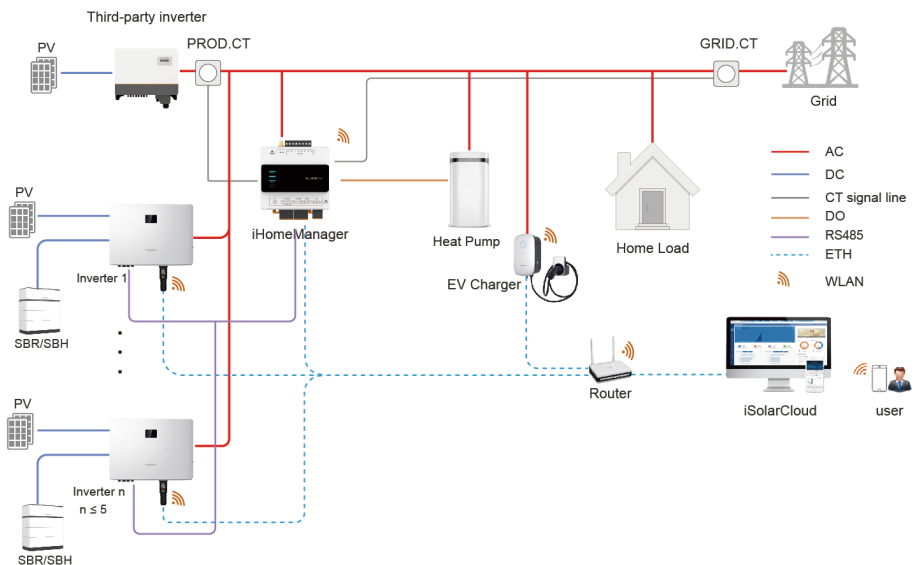

The compatible devices are listed below.

Inverter	Battery RACK	Charger
SH5.0~10RT-20 SH5.0~10RT SH5-25T	SBR SBH	AC22E-01
SH3.0~6.0RS	SBR SBS	

Retrofit system with SUNGROW inverter (WiNet)

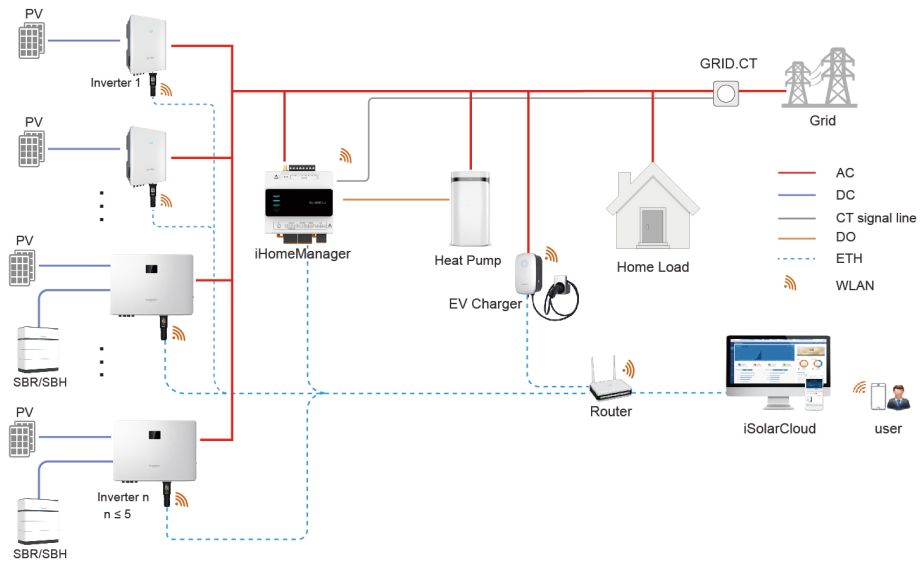

The compatible devices are listed below.

Inverter	Battery RACK	Charger
SH5.0~10RT-20 SH5.0~10RT SH5-25T	SBR SBH	AC22E-01
SG5.0-20RT SG5.0-20RT-P2	/	
SH3.0~6.0RS	SBR SBS	

Retrofit system with SUNGROW inverter (RS485)

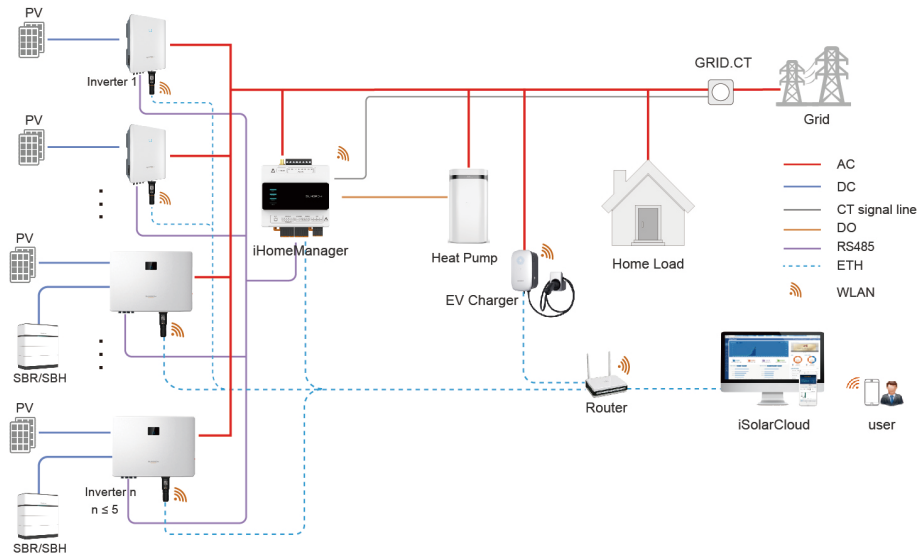

The compatible devices are listed below.

Inverter	Battery RACK	Charger
SH5.0~10RT-20	SBR	
SH5.0~10RT	SBH	
SH5-25T		
SG5.0-20RT	/	AC22E-01
SG5.0-20RT-P2		
SH3.0~6.0RS	SBR	
	SBS	

i See the user manual for the inverter for its compatible battery RACKS.

4.3 External Design

iHomeManager External Design

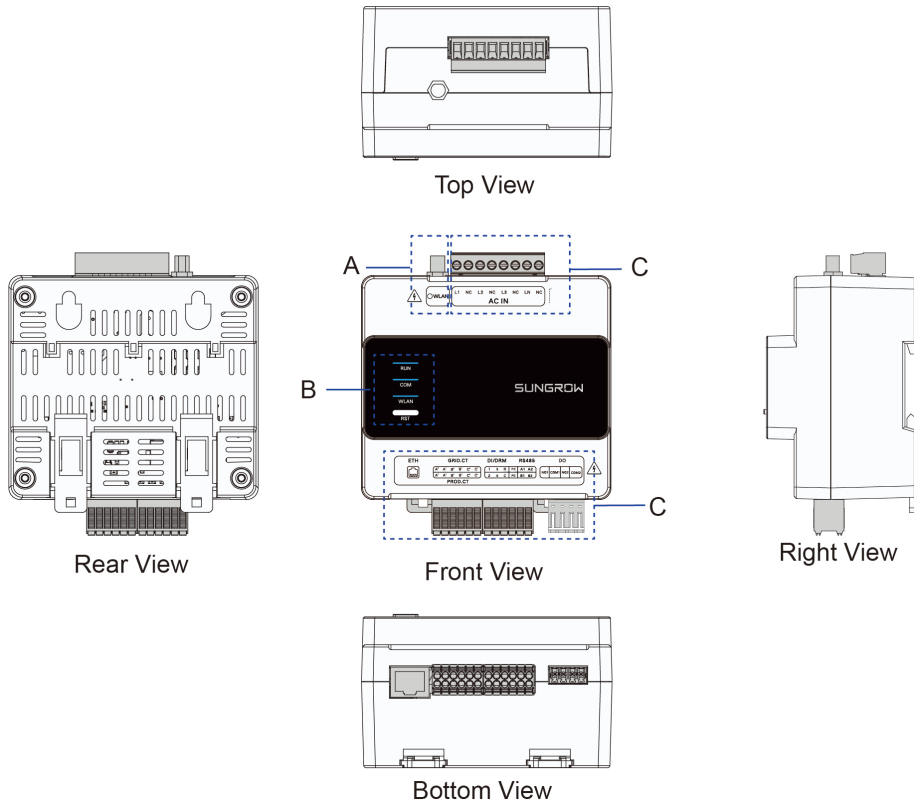

No.	Definition	Description
A	WLAN antenna connector	-
B	Indicators	Indicate the current status of the iHomeManager.
C	Terminals for connection	See Table 7-1 Terminal Description for details.

Indicators

Indicator	Color	Status	Description
RUN	Blue	Off	Not connected to power.
		Blinking	Operating normally.
COM	Blue	Off	No device is online.
		Steady on	All devices are online.

Indicator	Color	Status	Description
WLAN	Blue	Blinking	Some devices are online.
		Off	Not connected to cloud server.
		Steady on	Connected to cloud server.
		Blinking	Data interaction in progress.

RST Key

Operation	Description
Short press 3 times	Turn on the AP hotspot.
Press and hold for 3–10s	Restart the device.
Press and hold for over 30s	Reset to factory settings.

Product Dimensions

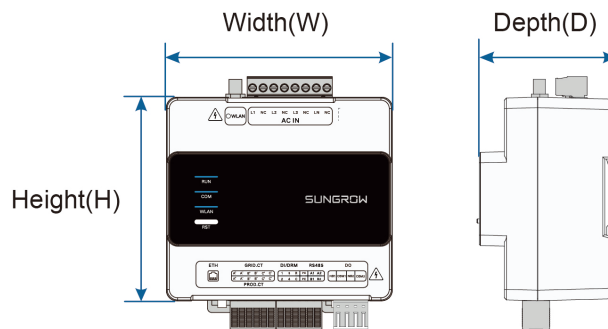

Width (W)	Height (H)	Depth (D)
108mm	95mm	65mm

Signs on the Product

Sign	Description
	Danger to life due to hazardous high voltages! Installation and operation must only be performed by qualified technical persons.

5 Unpacking and Storage

5.1 Scope of Delivery

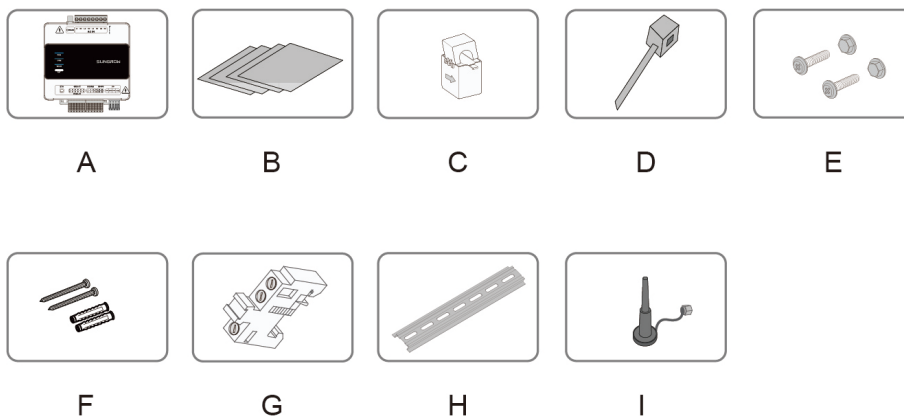

No.	Item	Description
A	Home Energy Manager	iHomeManager.
B	Documents	Quick Installation Guide, factory inspection report, packing list, warranty card, and quality certificate.
C	External CT	100A * 3 pcs (standard equipment).
D	Nylon cable tie	6 pcs; used to secure the cables.
E	Fastener assembly	M4X16, 4 sets in total; used to mount the device on a metal wall.
F	Expansion bolt	ST4.8X19, 4 sets in total; used to mount the device on a concrete wall.
G	End bracket	E/UK-1201442, 2 sets; mounted on the guide rail at the two sides of iHomeManager.
H	Guide rail	148mm in length.
I	WLAN antenna	External suction base antenna.

5.2 Unpacking and Inspection

The product has been thoroughly inspected and securely packaged before it leaves the factory. However, as it may still get damaged during transport, please carry out a thorough inspection before signing the delivery receipt.

- Check the delivered items for quantity and see if the delivery matches the order placed according to the packing list.
- Unpack and inspect the items inside for any damages.
- Check that the model of the product delivered to you is the one you have ordered.
- Check that the safety signs, warning labels, and nameplate on the product are all legible.



In case of any damage, do not install the device. Contact your transport service provider or SUNGROW, and provide relevant photos for further assistance.

5.3 Nameplate

The nameplate shows the model and key technical data of the product.

iHomeManagerThe iHomeManager has a nameplate on its side, as shown below.

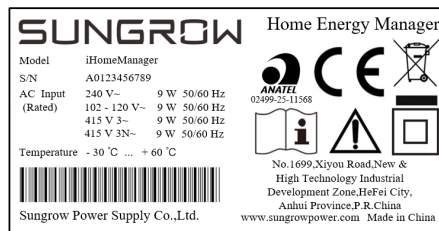







Table 5-1 Nameplate

Parameter	Definition
Model	Product model.
S/N	Product serial number.
AC Input	AC input requirements.
Temperature	Operating temperature range.
	Do not dispose of this product as household waste.
	CE compliance mark.

Parameter	Definition
	ANATEL mark of conformity.
	Please read the user manual.
	Equipment protected throughout by reinforced insulation.

Product over-voltage rating □ OVERVOLTAGE CATEGORY II.

Product Pollution Class □ POLLUTION DEGREE 2.

5.4 Storage Requirements

After receiving and inspecting the product, if you do not install or use it immediately, please store it properly.

⚠ CAUTION

Losses resulting from storage not in accordance with the instructions specified in this manual will not be covered by the warranty.

- To put the packaged products in stacks, ensure the maximum stack does not exceed 8 levels and proper protective measures are taken.
- Put the product in its original packaging and store it indoors in a ventilated, dry, and clean environment.
- The support structure on which the product is stored should be solid enough to bear the weight of the product and its packaging.
- Ensure the product is stored in a well-ventilated and moisture-proof place, without accumulation of water.
- The ambient temperature in the place where the product is stored should be between -40°C and +70°C, and the relative humidity should be between 0 and 95%, non-condensing.
- Avoid damages to the product caused by severe environmental conditions such as sudden temperature changes or collisions.
- Carry out regular inspections, generally at least once a week. Inspect the packaging for damages, and make sure there is no damage caused by pests and animals. Re-package the product immediately if its packaging gets damaged.



A thorough inspection should be performed on the product before installing it after a long storage, to make sure it is in a good state. If necessary, ask qualified personnel to test it before installation.

6 Mechanical Mounting

WARNING

Respect all local standards and requirements during mechanical installation.

6.1 Installation Requirements

An ideal installation position is critical to the safe operation, longer service life, and sound performance of the iHomeManager.

Take the following requirements into account when selecting the installation position:

- The device must only be installed indoors.
- Ambient temperature: -30°C to +60°C.
- Allowable humidity: ≤ 95%, non-condensing.
- The device should be protected against moisture, dampness, and corrosives.



Overly high humidity may cause damage to the internal components of the iHomeManager.



Losses resulting from installation not in accordance with the instructions specified in this manual will not be covered by the warranty.

6.2 Installation Tools

Installation tools to be used include but are not limited to those listed below. If necessary, use other auxiliary tools at the site.



Installation tools are not included in the scope of delivery and should be prepared by the installer.

6.3 Installation Methods

The iHomeManager must be installed in a power distribution box that has an SPD inside. It can be mounted on a wall or a guide rail, based on the user's needs.

⚠ CAUTION

Be sure to avoid the water pipes and electricity wires in the wall before drilling.

6.3.1 Mounted on a Wall

Prerequisite

The iHomeManager is mounted on a wall using the mounting holes.



The wall should be flat and solid.
The operators should wear safety goggles and dust masks, to prevent dust from getting into their eyes or mouths.
The iHomeManager can be mounted on a concrete or metal wall, based on the actual situation at the site.

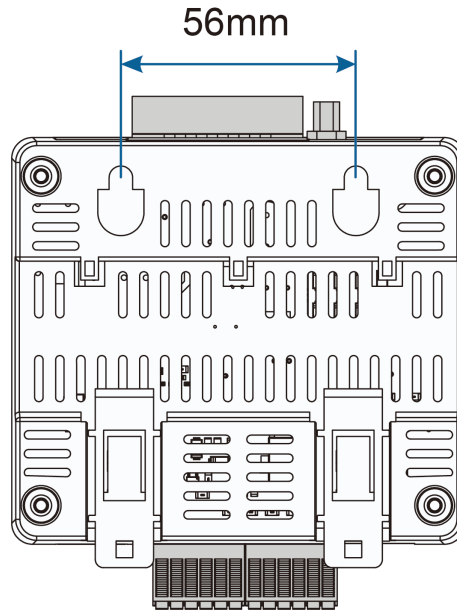
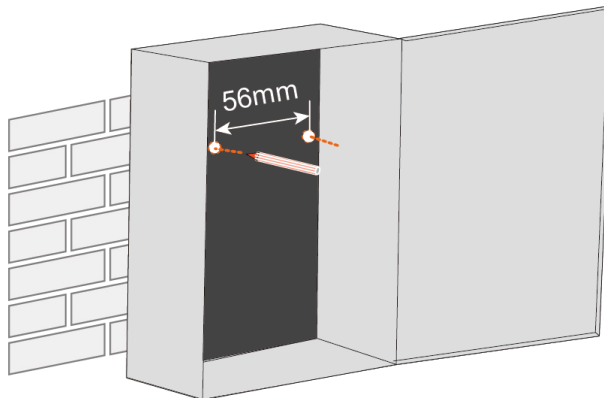

Figure 6-1 Mounting Holes

Step 1 Select an appropriate installation position.

Step 2 Measure and determine the positions of the two mounting holes using a tape measure. The distance between them is 56mm. Then, use a marker to mark the hole positions for drilling on the wall.



Step 3 Drill holes at the marked positions using a hammer drill.

- Hole diameter on a metal wall: 5mm;
- Hole diameter on a concrete wall: 6mm;

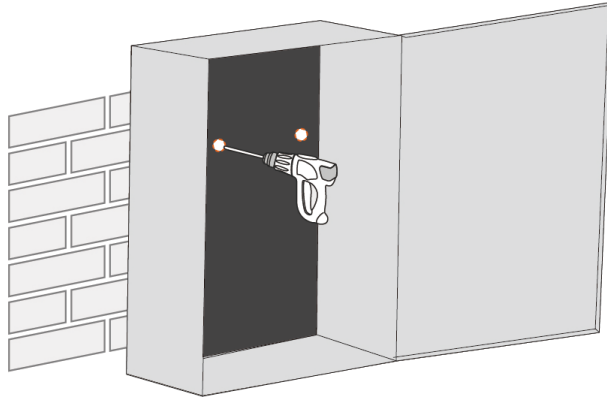

Step 4 Fit all the expansion sleeves into the holes using a rubber mallet.

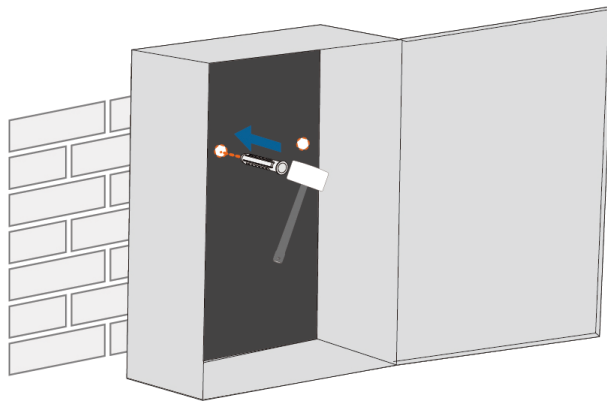

Skip this step if the device is mounted on a metal wall.

Step 5 Fix the expansion bolts or fasteners into the wall, approximately 5mm higher than the wall surface. Then, hang the iHomeManager to the bolts on the concrete or metal wall by the mounting holes on its back.

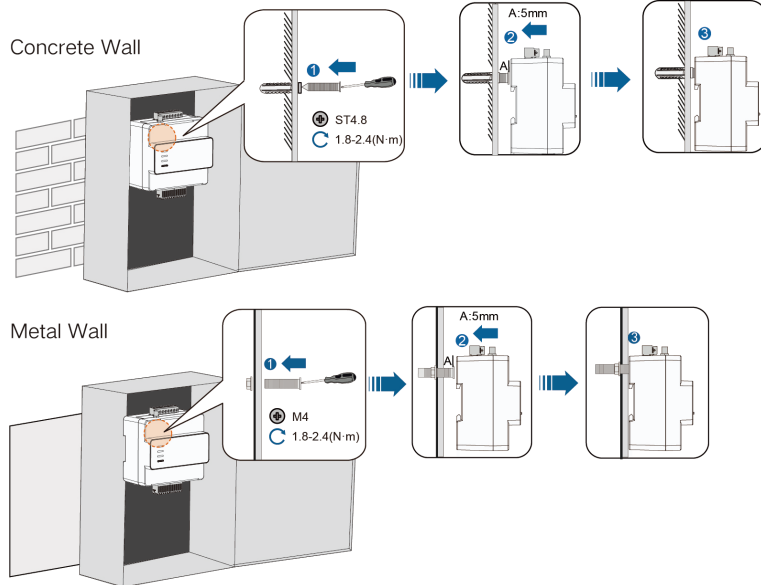

Step 6 Gently shake the iHomeManager to make sure the installation is secure.
 --End

6.3.2 Mounted on a Guide Rail

Prerequisite

The iHomeManager has clips on the back, which are used to attach it to the guide rail.

Step 1 Mount the guide rail in a proper position and fix it properly.

Step 2 Insert the tip of a Phillips screwdriver into the opening on the bottom clips of iHomeManager, then slightly drag downward to pull out the clips.

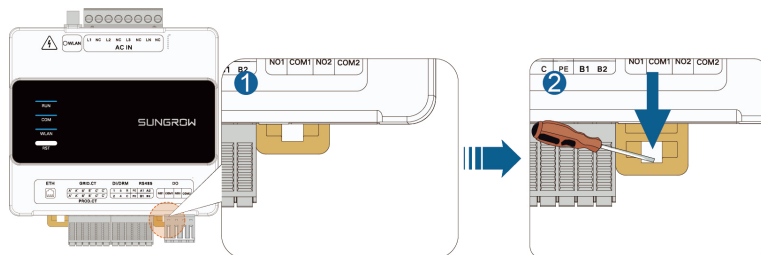

Step 3 Slightly tip the iHomeManager to have its clips latch onto the guide rail.

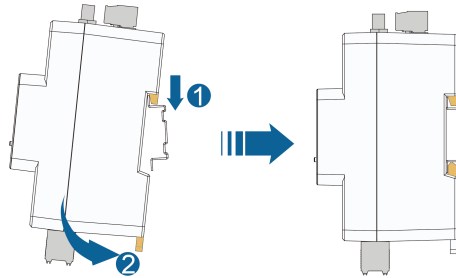

Step 4 Push the bottom clips upward. Make sure the iHomeManager firmly fits on the guide rail.

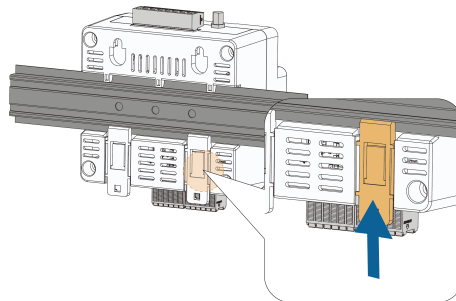

Step 5 Install the end brackets on the guide rail at both sides of the iHomeManager to restrict it in a fixed position.

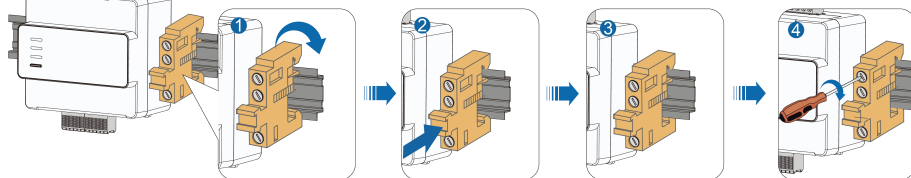

Step 6 Gently shake the iHomeManager to make sure the installation is secure.

--End

6.4 Antenna Installation



If the iHomeManager is installed in a metal enclosure or on a metal wall, put the antenna suction base outside of the enclosure or wall, to avoid impacts on signal transmission.

An external antenna is used by default. If no external antenna is connected, change the antenna settings on the iSolarCloud App. For details, see [9.9.1 iHomeManager Settings](#) in **Select Antenna**.

Requirements

- You have fixed the suction base in a position outside the metal enclosure or the metal wall.
- You have reserved an opening for the antenna (hole diameter: 20mm).

Step 1 Lead the nut end of the antenna cable to the iHomeManager.

Step 2 Rotate the nut clockwise to tighten it onto the WLAN antenna connector on the iHomeManager.

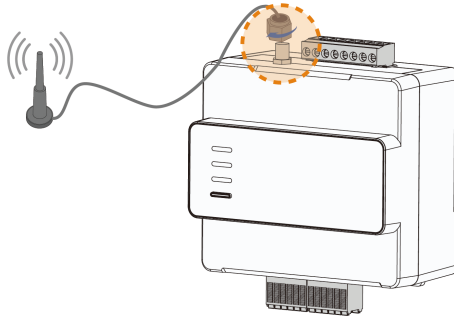

To ensure signal strength, it is recommended to install the antenna vertically.

--End

7 Electrical Connection

7.1 Wiring Notice

WARNING

Risk of product damage or personal injury due to improper wiring!

- A product can be wired only if it is intact without any signs of damage.
- The specification of cables used should meet the relevant requirements, and the cables should be well-insulated and firmly connected.

CAUTION

Risk of device damage due to improper wiring!

- The specification of cables used should meet the relevant requirements, and the cables should be well-insulated and firmly connected.
- During electrical connection, do not forcibly pull any wires or cables, as this may diminish their insulation performance.
- Ensure that all cables and wires have sufficient space for any bends.
- Adopt necessary auxiliary measures to reduce the stress applied to cables and wires.
- Keep a sufficient distance between the cables and the heat-generating components, to prevent the cable insulation layer from aging or getting damaged due to high temperature.

CAUTION

Damages resulting from wiring not in accordance with the instructions specified in this manual will not be covered by the warranty.

7.2 Terminal Description

External Interface

External wiring areas are set at the top and bottom of the iHomeManager.

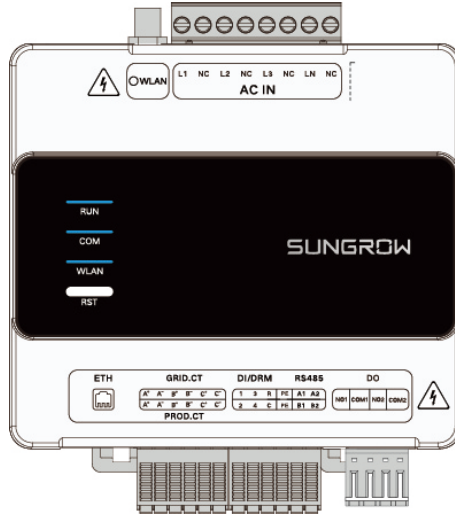

Table 7-1 Terminal Description

Name	Signal	Function
AC IN	L1	AC power supply L1
	L2	AC power supply L2
	L3	AC power supply L3
	LN	AC power supply N
ETH	/	Ethernet port. It can be connected to a router for data communication.
GRID.CT	A+, A-	Used for phase L1 current detection on the grid-connection side.
	B+, B-	Used for phase L2 current detection on the grid-connection side.
	C+, C-	Used for phase L3 current detection on the grid-connection side.
PROD.CT	A+, A-	Used for phase L1 current detection of the third-party inverter.

Name	Signal	Function
DI/DRM	B+, B-	Used for phase L2 current detection of the third-party inverter.
	C+, C-	Used for phase L3 current detection of the third-party inverter.
	1, 2, 3, 4	Used for DI power regulation.
	R, C	Used for emergency stop function (via short-circuiting connection).
RS485	A1, B1, PE	RS485 communication port; used to connected to the inverter.
	A2, B2, PE	
DO	NO1, COM1	Used for heat pump control.
	NO2, COM2	Reserved.

Service ports

This section describes the functions and default status of the product's service ports.

Table 7-2 Port Description

Port	Description
502	Used to connect SUNGROW devices or third-party management systems to iHomeManager via Modbus Transmission Control Protocol (Modbus TCP). By default, the port is enabled and SSL-encrypted by default.
503, 504	Used to connect SUNGROW devices or third-party management systems to iHomeManager via Modbus TCP. By default, ports 503 and 504 are disabled and are not SSL-encrypted. To use this port, tap More > iHomeManager settings > Forwarding channel settings to enable it.

Port	Description
516	Used to connect SUNGROW devices or third-party management systems to iHomeManager via Modbus Transmission Control Protocol (Modbus TCP). By default, the port is enabled and SSL-encrypted by default.
22	Used to connect to the server via Secure File Transfer Protocol (SFTP) for transferring data such as log files.
21	Used to connect to third-party devices via File Transfer Protocol (FTP). This port is disabled by default and is enabled only when required by the connected thirdparty device.
443	Used to connect to the local embedded Web or local App via Hypertext Transfer Protocol Secure (HTTPS).
67	Used to obtain IP addresses via Dynamic Host Configuration Protocol (DHCP).
5353	Used for fast network configuration via Multicast DNS (mDNS).
49152~65535	Used for the HTTP server to dynamically apply for a port for internal message communication.

7.3 Cable Requirements

Cable type	Specifications	Description
RS485 communication cable	Recommended cross-sectional area: 0.75mm ²	<ul style="list-style-type: none"> • Communication distance < 1000m • Outdoor-type anti-UV twisted-pair cable with a shielding layer
RJ45 Ethernet cable	Network cable of Cat5e or higher	Communication distance < 100m

Cable type	Specifications	Description
DI signal cable	Recommended cross-sectional area: 0.75mm ²	Communication distance < 10m
DO signal cable	Recommended cross-sectional area: 0.75–1.5mm ²	Communication distance < 10m
AC power supply cable	Recommended cross-sectional area: 2.5mm ²	Outdoor-type copper-core cable

7.4 Power Supply and CT Connection

Requirements

You have prepared the AC cable as required by [7.3 Cable Requirements](#).

⚠ DANGER

Accidentally touching the live terminals may result in fatal electric shocks.

- Before wiring, make sure the device is completely powered off.
- Before wiring, make sure the wiring terminals are voltage-free.

Step 1 Use wire strippers to strip off the protective layer of the AC cable by approximately 80mm–90mm, and the insulation layer by 12mm. It is suggested to crimp cold-pressed terminals on the cable wires. Install appropriate cord end terminals on the communication cables after removing the protective layer, and use a crimping tool to securely crimp them.

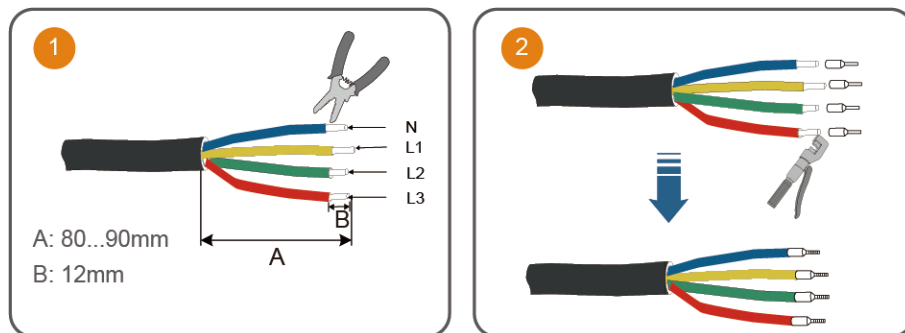

Step 2 Connect one end of the AC cable to the iHomeManager, with its wires connected to L1, L2, L3, and LN respectively.



For a single-phase system, connect one end of the AC cable to L1 and LN on the iHomeManager.

Step 3 Connect the other end of the AC cable to the corresponding position on the household circuit breaker.

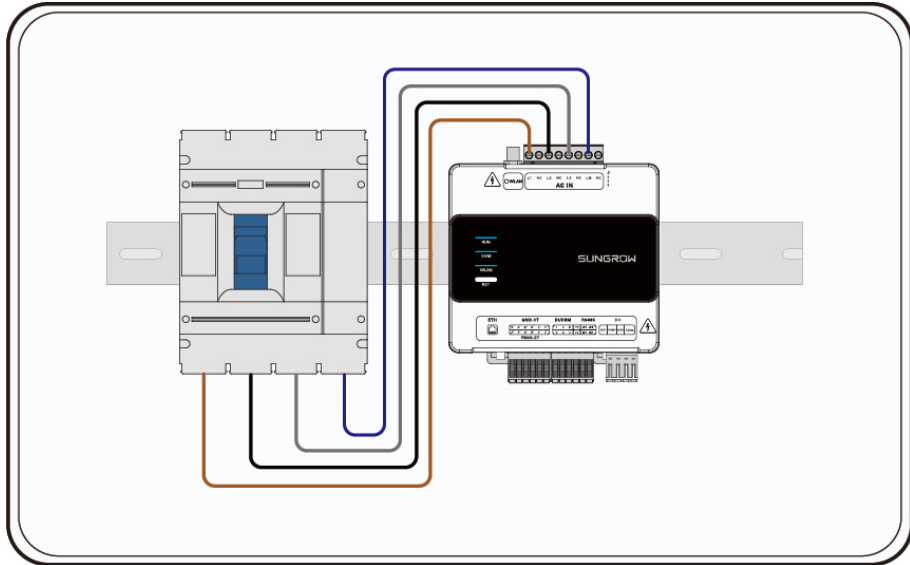

Step 4 Connect the CT wires to the GRID.CT terminal, and clamp the CT to the AC cable with the arrow pointing in the direction of the load.

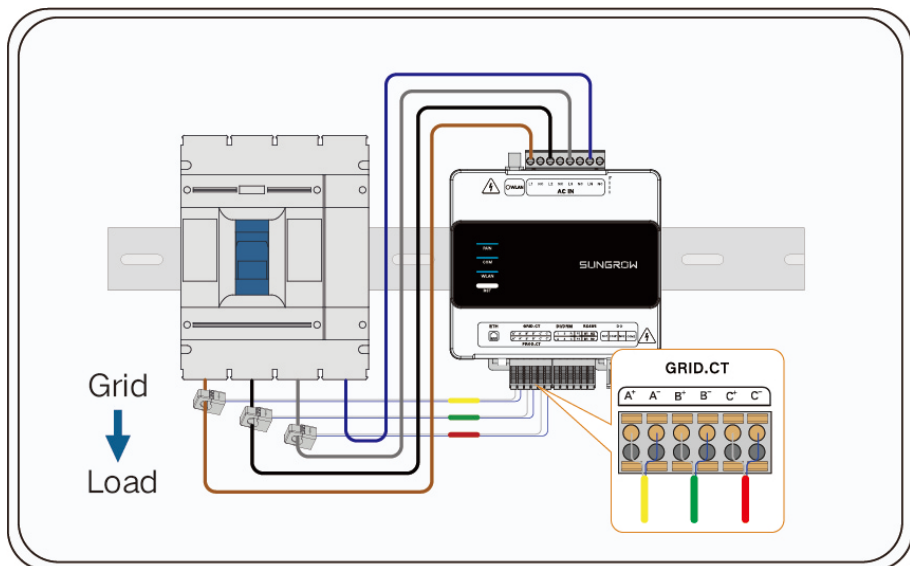

For a single-phase system, connect the CT wires to the phase A terminals (A+ and A-) in the GRID.CT terminal.

--End

7.5 Inverter Connection via RS485

Prerequisite

The iHomeManager is connected to the inverter via RS485 connection in the scenario of [Residential PV-ESS-EV Charging System \(via RS485\)](#).

Requirements

You have prepared the RS485 communication cable as required by [7.3 Cable Requirements](#).

⚠ DANGER

Accidentally touching the live terminals may result in fatal electric shocks!

- **Before wiring, make sure the device is completely powered off.**
- **Before wiring, make sure the wiring terminals are voltage-free.**

⚠ CAUTION

The RS485 communication cable must be a shielded twisted-pair cable and its shielding layer must be connected to the PE terminal for grounding.

Step 1 Lead the RS485 communication cable from the inverter to the wiring area on the iHomeManager.

Step 2 Use wire strippers to strip off the protective layer of the cable by approximately 15mm, and the insulation layer by 8mm–10mm.

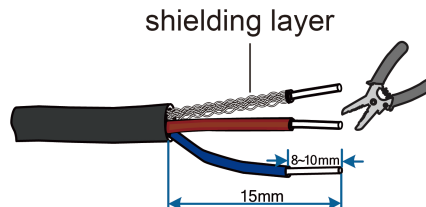

Step 3 Choose wiring terminals with the proper size, and crimp the terminals onto the wires of the RS485 cable. Then, connect the wires to the corresponding positions in the RS485 port of the iHomeManager.

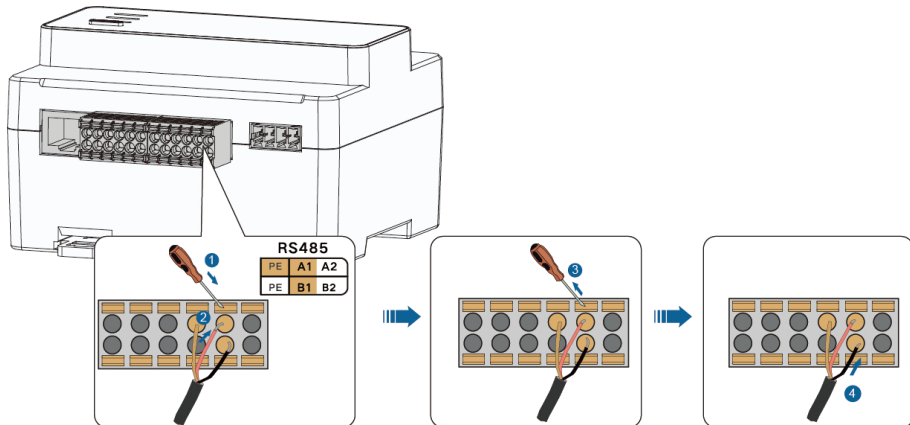

i Connect RS485A to point A and RS485B to point B.

i If a multi-core RS485 cable is used, choose European terminals with the proper size, and crimp the terminals onto the cable wires. Then, connect the wires to the corresponding positions in the RS485 port of the iHomeManager.

Step 4 Connect the other end of the communication cable to the RS485 port on the inverter. The connection port of the inverter model shown below is taken as an example. Please refer to the actual port of the used device model.

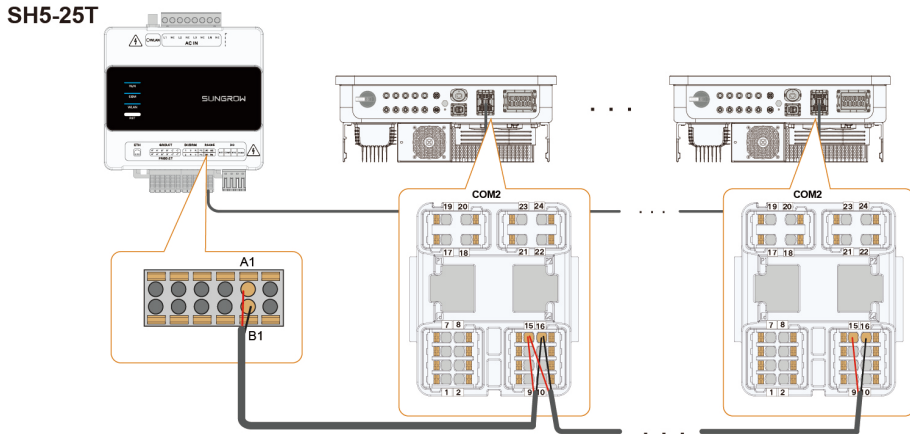

SH5.0~10RT-20

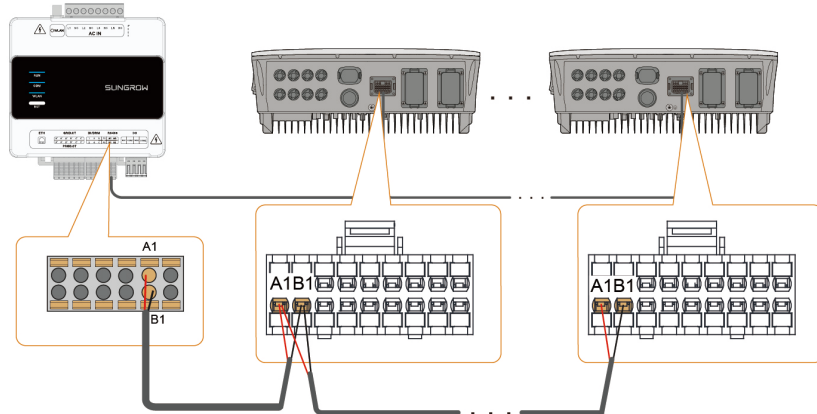

SH3.0~6.0RS

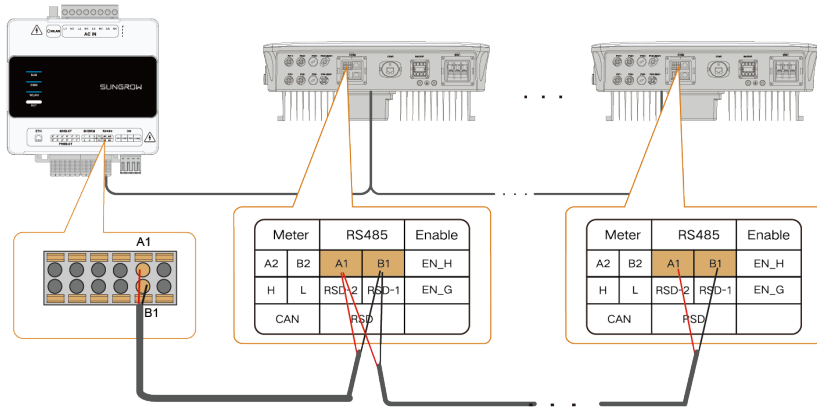

In a system with different models of SUNGROW inverters, the inverters can all be connected with each other through RS485 cables. Refer to the diagrams above for connection points.



In multi-inverter scenarios, it is recommended to connect models SG5.0-20RT and SG5.0-20RT-P2 via the Ethernet or WLAN using WiNet-S2.

--End

7.6 (Optional) CT Connection for Third-Party Inverter

Prerequisite

If the third-party inverter is used at the site, add CTs at the AC output of the inverter.

⚠ DANGER

Accidentally touching the live terminals may result in fatal electric shocks.

- Before wiring, make sure the device is completely powered off.
- Before wiring, make sure the wiring terminals are voltage-free.

Step 1 Connect the CT wires to the PROD.CT terminal and clamp the CT to the AC cable, with the arrow pointing in the direction of inverter.

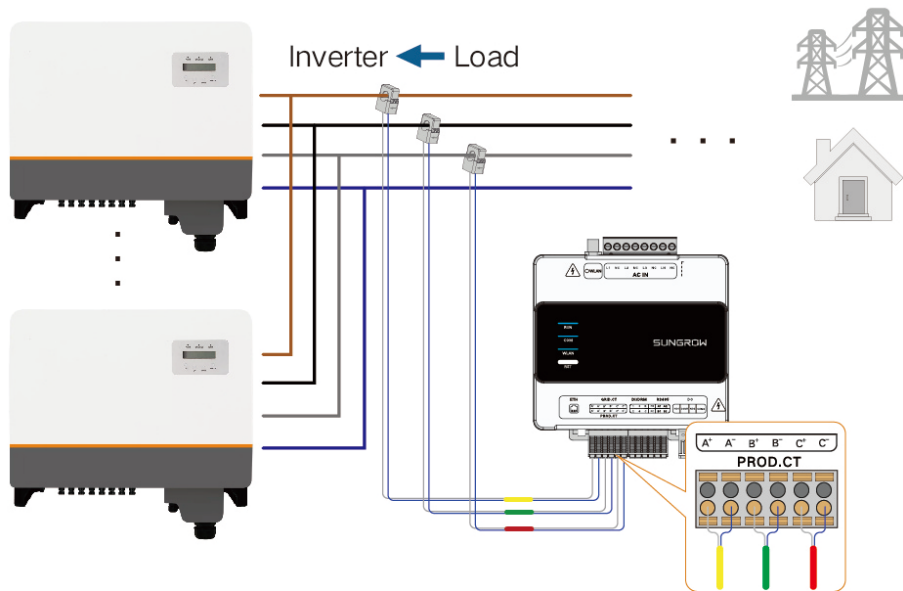

--End

7.7 Heat Pump Connection via DO

Prerequisite

The iHomeManager controls the start and stop of the heat pump via DO signals. One heat pump can be connected.

Requirements

You have prepared the DO signal cable as required by [7.3 Cable Requirements](#).

⚠ DANGER

Accidentally touching the live terminals may result in fatal electric shocks.

- Before wiring, make sure the device is completely powered off.
- Before wiring, make sure the wiring terminals are voltage-free.



- A DC signal of max 30V/3A or an AC contactor must be installed between the inverter and the load. It is forbidden to connect the load directly to the DO port.
- The current of the DO dry contact should not be larger than 3 A.
- The DO node is not controlled once the inverter is powered off. Connect the AC contactor by the manual switch, so as to control the loads.

Step 1 Lead the DO signal cable from the heat pump to the wiring area on the iHomeManager.

Step 2 Use wire strippers to strip off the protective layer of the cable by approximately 15mm, and the insulation layer by 8mm–10mm.

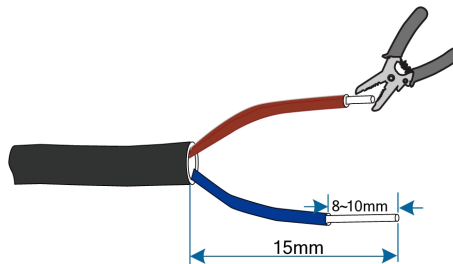

Step 3 Connect one end of the cable to the communication port on the iHomeManager, and the other end to the communication port on the heat pump.

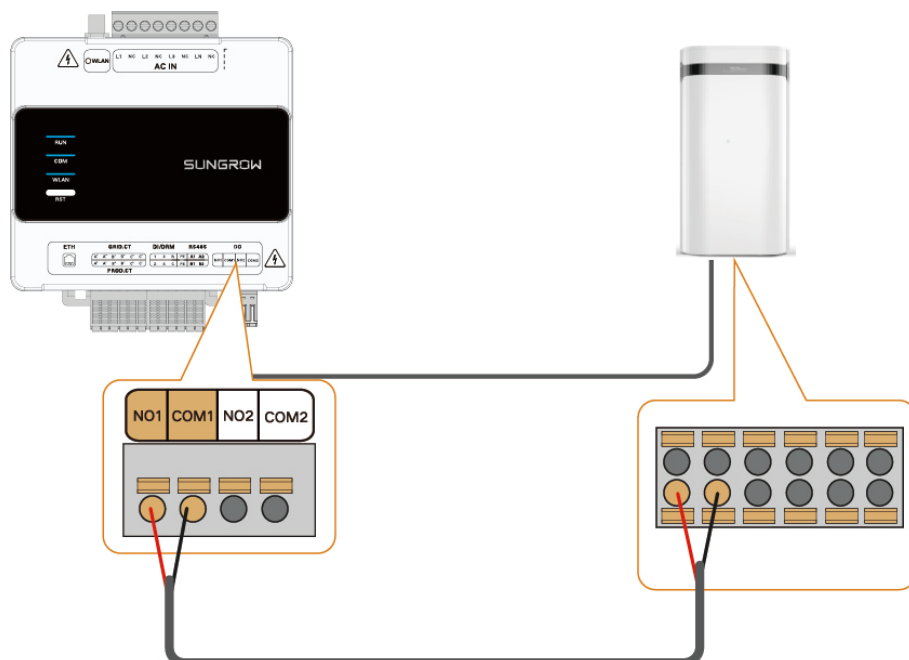

The heat pump and connection points shown in the above figure are for illustration only. For the connection points to be used in actual wiring, please refer to the user manual for the heat pump.

--End

7.8 Router Connection

DANGER

Accidentally touching the live terminals may result in fatal electric shocks.

- Before wiring, make sure the device is completely powered off.
- Before wiring, make sure the wiring terminals are voltage-free.



Before connection, make sure the router has connected to an external network.

Network cable connection

iHomeManager can be connected to a router with a network cable.

1. Prepare a network cable with an appropriate length.
2. Connect the network cable to the LAN port of the router on one side, and to the ETH port of the iHomeManager on the other side.
3. Complete Ethernet parameter settings. See [9.4.1 Network Configuration](#) for details.

WLAN connection

iHomeManager can also be connected to a router over WLAN.

1. Open the iSolarCloud App, tap **Local Access** at the bottom of the login screen, and scan the QR code on the device enclosure.
2. Go to **Identity Verification**, and enter your account name and password.
3. On the **Home** screen, tap  in the upper right corner to go to **Network Configuration**.
4. Select an available WLAN, enter the correct password, and connect to the WLAN network. See [9.4.1 Network Configuration](#) for details.

7.9 DI Connection

Prerequisite

Users can connect an external device to the DI port on the iHomeManager for DI power regulation.

Prerequisites

You have prepared the DI signal cable as per the specifications requirements in [7.3 Cable Requirements](#).

⚠ DANGER

Accidentally touching live terminals may result in fatal electric shocks!

- **Before wiring, make sure the device is completely powered off.**
- **Before wiring, make sure the wiring terminals are voltage-free.**

Step 1 Use wire strippers to strip off the protective layer of the DI communication cable by approximately 15 mm, and insulation layer by 8 mm–10 mm, as shown in the figure below.

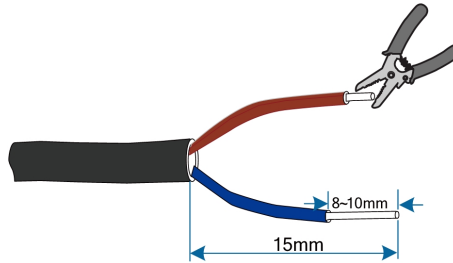

Step 2 Connect the external device to DI port for ripple control. The ripple control function needs to be configured on the iSolarCloud App.

- Ripple Control: Connect the external device to points 1, 2, 3, 4, and C of the DI port for ripple control.

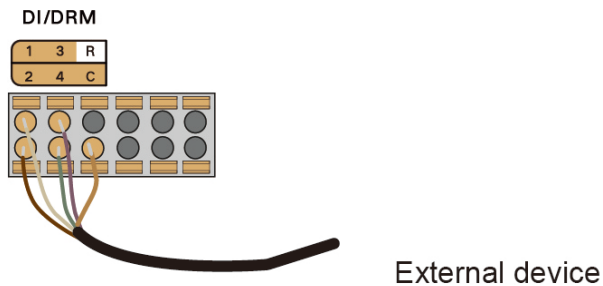

- EnWG 14a: Connect the external device to points 4 and C of the DI port for EnWG 14a.

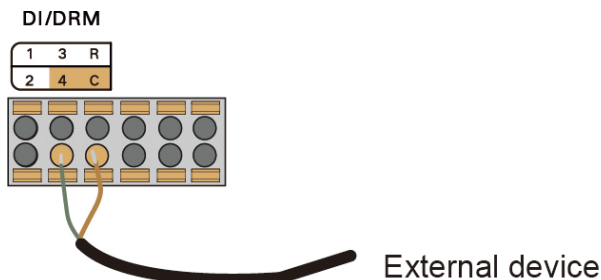

Step 3 Connect the signal wire from the emergency stop device to the points R and C of the DI port. This is used to allow emergency stop control of the inverter.

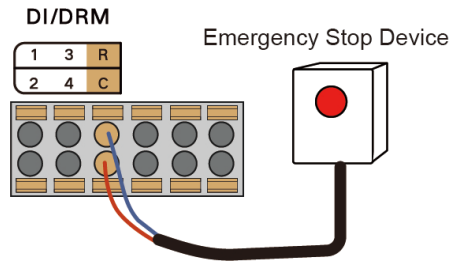

--End

8 Commissioning

It is recommended to complete device commissioning by following the flowchart below.

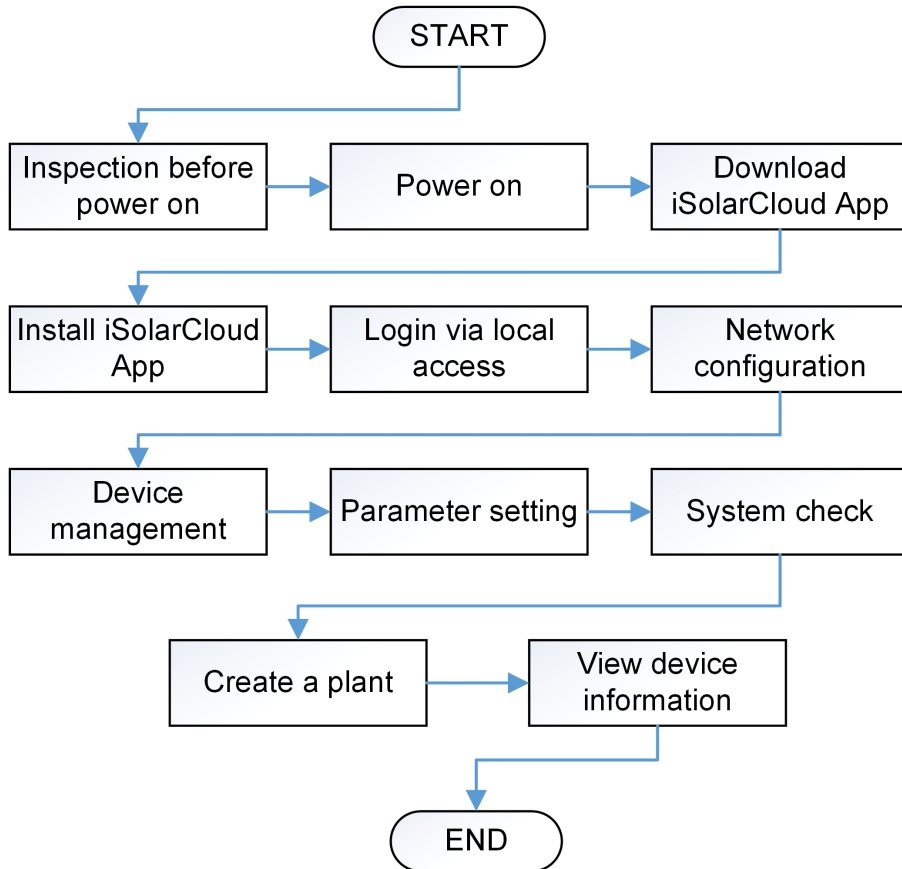

8.1 Inspection Before Powering on

⚠ DANGER

To power on the device, wear specialized protective equipment and use specialized insulated tools properly, so as to avoid electric shocks or short-circuits in the device.

No.	Inspection item	Result
1	The iHomeManager is installed correctly.	<input type="checkbox"/>
2	Check that all cables are intact, well-insulated, and properly sized.	<input type="checkbox"/>

No.	Inspection item	Result
3	Check that all cables are properly and securely connected.	<input type="checkbox"/>
4	The power line and signal line are laid in compliance with the requirements for strong and weak electricity wiring.	<input type="checkbox"/>
5	The cables are organized and secured properly and neatly, with the cable ties evenly spaced, moderately tight, and oriented in the same direction.	<input type="checkbox"/>
6	No excess tape or ties are left on the cables.	<input type="checkbox"/>

8.2 Power-on Process

No.	Steps	Result
1	Inspection before powering on.	<input type="checkbox"/>
2	Close the battery switch.	<input type="checkbox"/>
3	Close the inverter's DC switch.	<input type="checkbox"/>
4	Close the switch between the inverter and the grid.	<input type="checkbox"/>
5	Close the switch between the iHomeManager and the grid.	<input type="checkbox"/>
6	Check the status of the indicator on the iHomeManager, by referring to Indicators .	<input type="checkbox"/>
7	Set the operation parameters for the device on the iSolarCloud App by following the instructions in 9.4 Quick Setting .	<input type="checkbox"/>

9 iHomeManager Configuration with iSolarCloud

9.1 About iSolarCloud App

The iSolarCloud App is a mobile application used for new energy power plant management. It is designed with functions such as plant operation data display, quick plant access, remote parameter setting, quick fault location and notification, as well as production and revenue analysis. Easy and efficient, the iSolarCloud App offers plant operation analysis service and allows intelligent end-to-end mobile O&M for users.

9.2 Preparation

9.2.1 Install iSolarCloud

Prerequisite

This section introduces how to download and install the iSolarCloud App.

Procedure

Step 1 Search for **iSolarCloud** in App Store, Google Play or other App stores, or scan the QR code below with a mobile phone and download the App by following the onscreen instructions.



Step 2 Tap the downloaded installation package and follow the onscreen instructions to complete the installation. The icon of iSolarCloud will then appear on the screen.



--End

9.2.2 Local Access

Step 1 Open the iSolarCloud App, and tap **Local Access** in the lower left corner of the login screen.

Step 2 Scan the QR code on the enclosure of the iHomeManager.

Step 3 Enter the account name and password, and tap **Verification**. The default account name and password are shown in the table below:

User type	Username	Password	Permissions
General user	user	pw1111	Granted access to monitoring and general settings. For instance, Overview, Device Monitoring, and some of the History Data.
O&M user	admin	pw8888	Operations mentioned in this manual.
Developer Account	develop	Dynamic password	Login with a developer account is allowed only after authorization by an O&M user account.

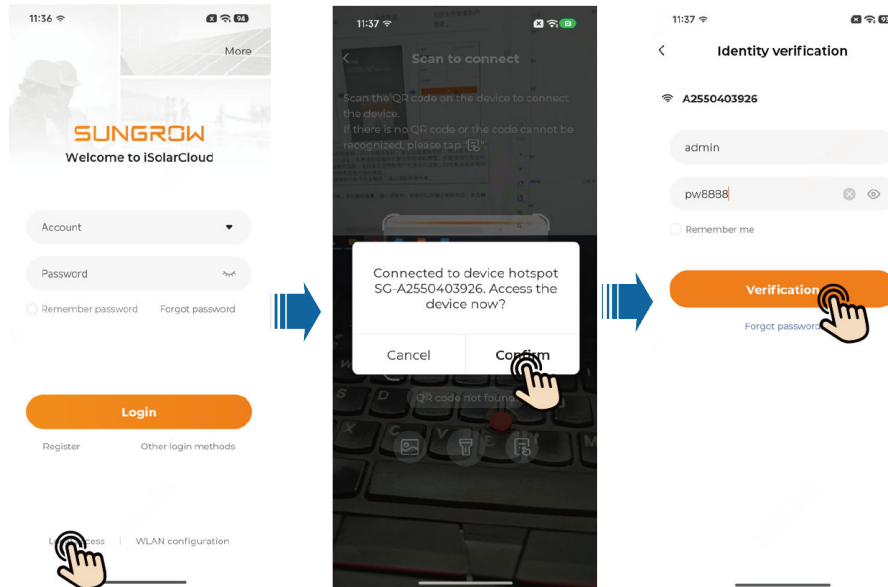

At your first login, please use the default password and change the password as soon as possible. To keep your account secure, it is recommended to update your password regularly and always make sure you remember the new one. You may see a password leak if you do not change the default password, or an increased risk of the account getting hacked or compromised if you use the default password for a long time. Besides, you may not be able to access the device if you have lost your password. All these situations may cause losses for the plant, and such losses shall be borne by users. Functions available to the **User** and the **Installer** accounts may differ.

Step 4 A message will show on the screen asking you to change your password. Tap **Go to set**. Then, enter the original password and new password, confirm the new password, and tap **Confirm**.

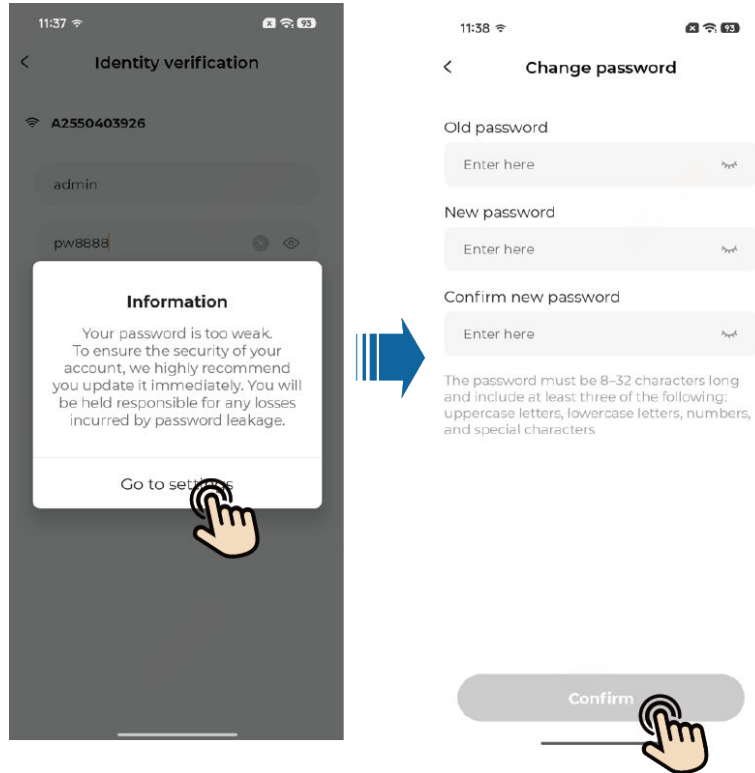

The password should be 8–32 characters long and contain at least three of the following four character types: uppercase letters, lowercase letters, numbers, and special characters.

Step 5 Log in again with the new password.

--End

9.3 App Overview

After logging in, you will go to the **Home** screen by default, as shown in the figure below.

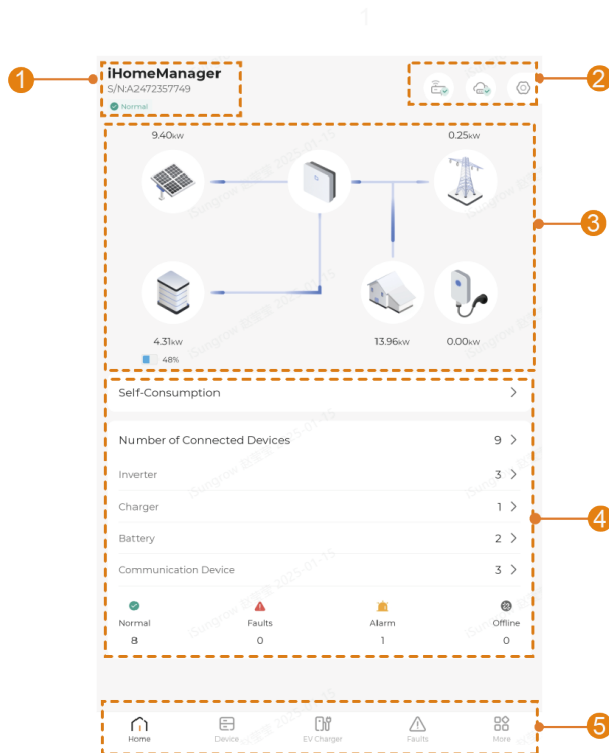

No.	Definition	Description
1	Device name	Shows the model, S/N, and status of the current device.
2	Toolbar	Provides access to network settings, cloud server selection, and quick settings.
3	Plant operation information	Shows the key plant data, such as the total PV power, feed-in/energy purchasing power, and load power. Battery charging/discharging power will also be shown if a battery has been added to the plant.
4	Device operation information	Shows the type, number, and running status of the devices that have been added to the plant. You can tap on the device type or running status to go to the list of the corresponding devices.

No.	Definition	Description
5	Navigation bar	<ul style="list-style-type: none"> • Home: View the operation information of the plant and the devices. • Device: Check and maintain the connected devices. • EV Charger: Check and set the working mode, running status, and charging parameters for the charger. This tab is available only if an EV charger is added. • Faults: View the fault information of the connections between iHomeManager and the connected devices. • More: Set the energy management, power control, intelligent load, and device parameters.



The navigation bar and available functions may slightly differ by account permission. In such cases, the App you actually use should take precedence. The instructions below are provided based on a Retailer/Installer account, unless otherwise specified.



After logging in for the first time, you will go to [9.4 Quick Setting](#) by default.

9.4 Quick Setting



For the AC22E-01 firmware version lower than LE-01.1E1.001.101.34, please refer to this document https://support.sungrowpower.com/PdfDetail?id=1942479071067181058&language_id=1, and follow the AC22E-01 firmware upgrade process to upgrade to a version compatible with iHomeManager.

"Quick Setting" offers simplified network connection settings, grid connection settings, and cloud access configuration. You can also set the device parameters here.

- First login
After logging in for the first time, you will go to "**Quick Setting**" automatically. You can complete device initialization by following the steps below.



Network
Configuration



Device
Management



Parameter
Settings



System
Self-test

- Subsequent login

If it is not your first login, tap  in the upper right corner of the **Home** screen to go to **“Quick Setting”**.



- During quick setting, do not power off or restart the router or the inverter, communication module, and charger connected to the iHomeManager.
- For a retrofit system using SUNGROW inverter, the inverter and communication module will undergo a firmware update and factory reset. Please wait for device initialization to complete first before proceeding with quick setting.

9.4.1 Network Configuration



If multiple routers are used at the site, ensure the iHomeManager, communication module, and charger are connected to the same local area network (LAN) and can communicate with each other properly.

Connecting the iHomeManager to the home router via Ethernet cable is preferred. If using the WLAN connection, ensure that the router's WLAN gets full bars in signal strength and operates at 2.4 GHz.

You can check the WLAN signal strength in the following two ways. If the signal bars are not full, it is recommended to adopt Ethernet communication.

1. Choose **Network > WLAN connection** to check the signal strength of the router's WLAN.
2. Choose **More > System Information** to check the signal strength of the router's WLAN to which the device is currently connected.



System Information

Interface Information	Meter Information
DI ^	
D11	Disconnected
D12	Disconnected
D13	Disconnected
D14	Disconnected
DO ^	
DO1	Disconnected
DO2	Disconnected
Emergency Stop Status	Disconnected
Antenna Status	External
WLAN Signal Strength	



- To connect a mobile phone directly to the device, ensure the phone is within the coverage of the device's WLAN signal.
- To connect the device to the router via WLAN, ensure the device is within the coverage of the router's WLAN signal and the signal is good and stable.
- The router should support WLAN (IEEE 802.11/B/G/N, 2.4 GHz) and the WLAN signal should cover the inverter.
- WPA, WPA2, and WPA/WPA2 encryptions are recommended for the router; enterprise-level encryption (e.g., airport WLAN and other public networks that require authentication) is not supported; while WEP and WPA TKIP encryptions are not recommended because of their severe security defects. If WEP is adopted and the connection fails, go to the router configuration page and change the encryption to WPA2 or WPA/WPA2.

• WLAN Connection

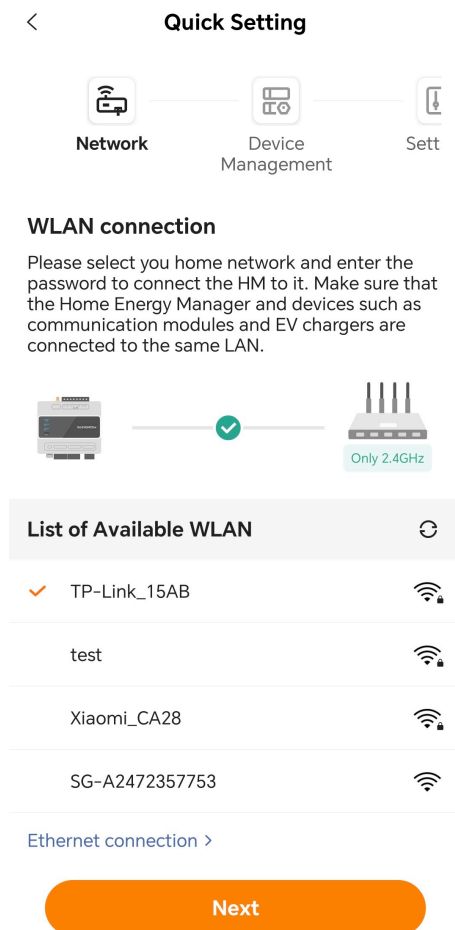

1. Select the target home network in the list of available WLANs.
2. Enter the password and tap **Confirm**.

- DNS1
- DNS2



If you manually turned on **Automatically Obtain IP Settings (DHCP)**, tap **Confirm** to establish an Ethernet connection.

3. If there are devices connected to the router via WLAN at the site, turn on **WLAN Sharing**. This function allows you to share your WLAN username and password with other wirelessly connected devices and complete network settings in one click.
4. Select the target home network in the list of available WLANs.
5. Enter the password and tap **Confirm**.
6. Tap **Next** after a successful connection to go to [9.4.2 Device Management](#).

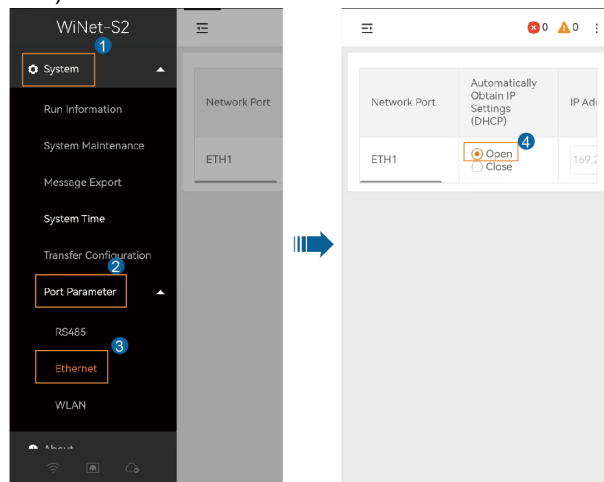

If the communication module is connected to the router with an Ethernet cable, log in to the module's built-in Web system and turn on "Automatically Obtain IP Settings (DHCP)" in advance.



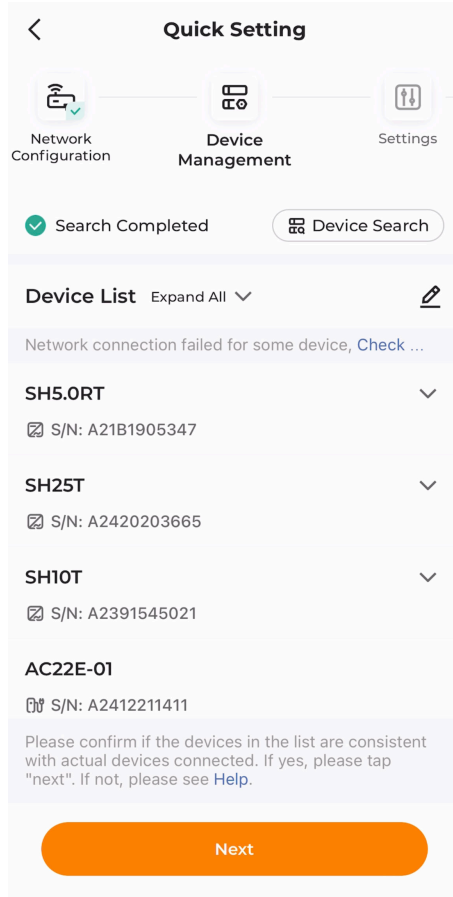

9.4.2 Device Management

After the network configuration is completed, go to **"Device Management"**. The system will scan for nearby devices automatically. Once the scan is finished, verify that the devices in the list match the actual networked devices. This step can be temporarily skipped. For future maintenance and management, see [9.10 Device List](#) for details.





- If there are fewer devices in the list than actual networked devices, check that the communication is normal and then tap **Device Search** in the upper right corner or [Add devices manually](#).
- If there are more devices than the actual networked devices, tap  to go to the **Edit Device List** screen, then tap  to delete the unnecessary ones.

Add devices manually

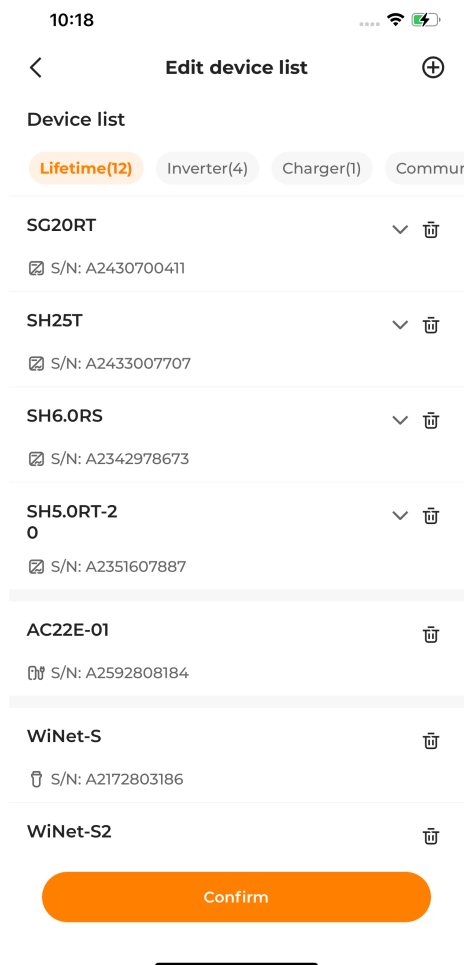
On the **Device Management** screen, tap  to go to the **Edit Device List** screen. Tap .



- Choose **Add Module**:
 1. Option 1: Scan the QR code on the communication device and tap **Confirm**.
 2. Option 2: Tap  to upload a picture of the communication device's QR code and tap **Confirm**.
 3. Option 3: Tap , select the type of the communication device, enter the device S/N, and tap **Confirm**.
- Select **Add Charger**:
Enter the charger S/N, and tap **Continue**.

Once the device is added, tap **Confirm** to go back to “**Device Management**”, and then tap **Next** to go to [Device initialization](#).

Device initialization

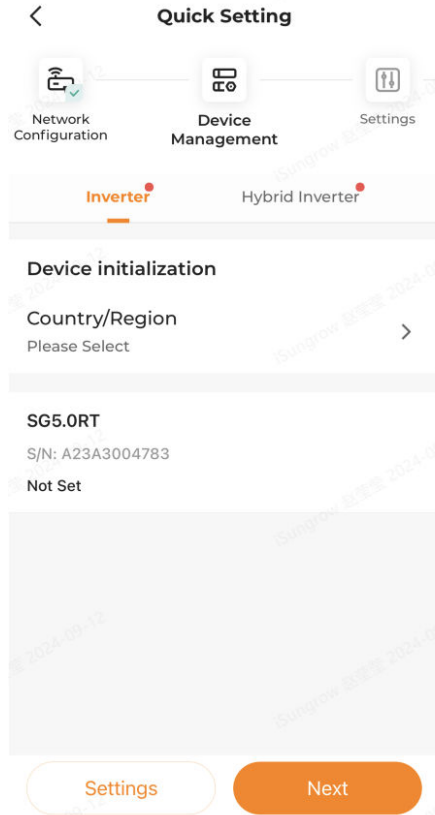

1. Tap **Country/Region**, select the country/region where the device is located or the standard for grid connection, and tap **Confirm** in the upper right corner.
2. Go back to “**Device Management**” and tap **Set** to apply the settings.
3. After all devices are set up successfully, tap **Next** to go to [9.4.3 Parameter Settings](#).



If both the PV inverter and the hybrid inverter are used, complete the settings for both in their respective tabs upon first setup. If settings in a tab is missing, you'll need to return to the tab later to finalize them.

9.4.3 Parameter Settings

You can set the energy management mode and power control parameters for the device in “**Settings**”. This step cannot be skipped.

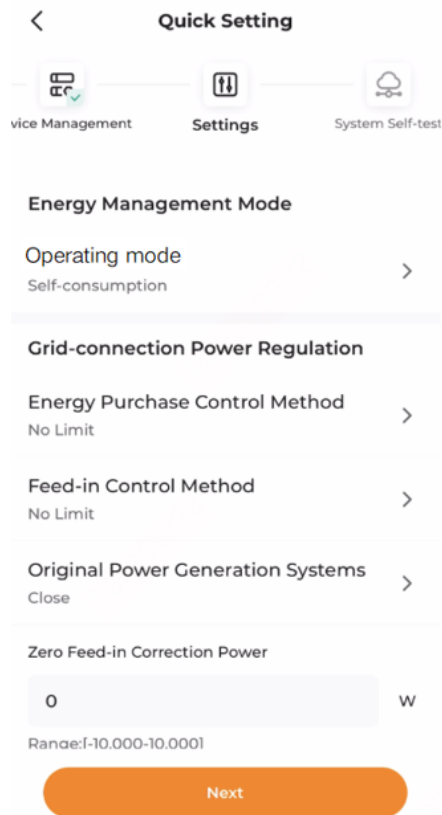

Energy management mode

The system provides various energy management modes to ensure effective energy management and maximization of energy utilization.

1. On the **Settings** screen, tap **Operating mode**.
2. Select a working mode for the device.

Grid-connected power regulation

Energy management mode allows users to set power limits on energy purchase and feed-in.

Set the grid-connected power regulation parameters.

After completing the settings, tap **Next** to go to [9.4.4 System Self-test](#).

9.4.4 System Self-test

A connection check will be performed by the system automatically once you go to "**System Self-test**". You can then check whether the communication between devices is normal.

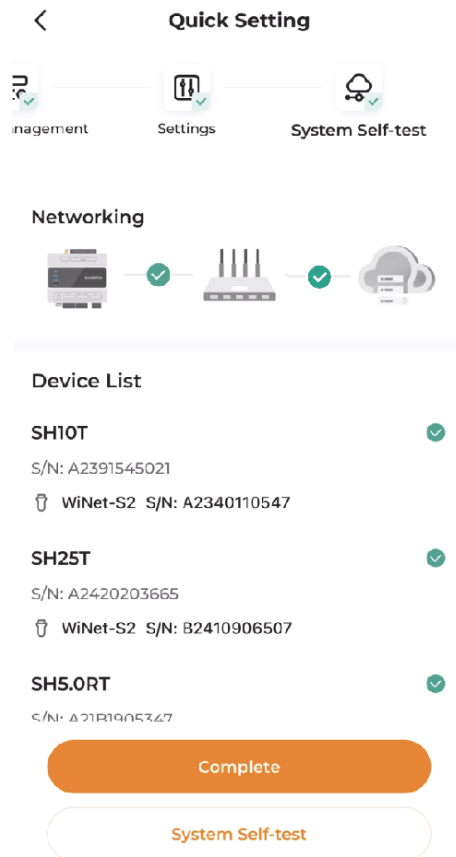

1. If the communication is abnormal, perform an inspection by following the onscreen instructions.
2. Tap **System Self-test** at the bottom of the screen.
3. If the system check is finished without detecting anything abnormal in the devices, tap **Complete**.
4. Choose whether to create a plant now.
 - Tap **Continue** to go to [9.4.5 Create Plant](#).
 - Tap **Not Now** to go to the **Home** screen.

9.4.5 Create Plant



To enter the **Create Plant** screen, please switch to the mobile data or connect your mobile device to a home network, and then go back to the App.

1. Fill in the **Basic Plant Information**:

Parameter	Description
Plant Name*	Name the plant.

Parameter	Description
Installed PV Power (kWp)*	Enter the installed power.
Plant Type*	Select the type of the plant: <ul style="list-style-type: none"> Residential PV plant Residential energy storage plant
City*	The city where the plant is located.
Postal Code	The postal code of the place where the plant is located.
Country/Region*	The country/region where the plant is located.
Time Zone*	Completed automatically according to the country/region you have selected.
Grid-connection Type*	Select the type of grid connection for the plant: <ul style="list-style-type: none"> 100% Feed-in Self-consumption Zero-export Off-grid
Grid-connection Date	Shows the current date by default. You can tap  to set the grid-connection date as needed.



* indicates required fields.

2. Fill in the **Retailer/Installer Information:**

Enter the **Retailer/Installer Email Address**. You can select the **Notifying the installer via email** checkbox as needed. The retailer/installer can log in to the App using the email address and check the plant in the plant list.

3. Fill in the **Owner Information:**

Enter the **Owner's Address**. You can select the **Notifying the property owner via email** checkbox as needed. The owner can log in to the App using the email address and check the plant in the plant list.

4. Set tariffs.

a. Set your preferred currency in **Unit**.

b. Set the **Feed-in Tariff** and the **Consumption Tariff**, and select the **Tariff Type**:

- Fixed tariff:** Rate charged for electricity consumed at different times of day is the same.
- Time-of-Use Tariff:** You can set different rates for electricity consumed in different time windows of the day. The time windows cannot overlap.

5. Tap **Save and Continue.**

9.4.6 View Plant Information

After a plant is created, users can log in to the system, using the previously provided retailer/installer email address or owner email address, and view the information about the plant.

9.4.7 View Device Information

After completing the quick settings, go back to “**Home**”. You can then tap the number of connected devices, device type, or device status to open the list of the corresponding devices. For detailed instructions, see [9.10 Device List](#).

9.5 EV Charger Settings (Optional)(Optional)

If a charger has been added to the plant, the **Charger** tab will appear in the navigation bar of the App.

iHomeManager is compatible with the following models of Sungrow chargers:

- AC22E-01



The **User** can set the charging mode and other parameters in the **Charger** page, while the **Retailer/installer** can view the data only but cannot take any action.



Charging modes and parameter setting instructions below are provided with a **User** account as an example.



Start Charging

1. Plug the charging connector into the charging port on the EV.
2. Set the Charging mode.
3. Set the Multi-charger control strategy.
4. Specify a value of Mileage per kWh.
5. Check that the charger status changes to **Standby**.
6. Tap **Start charging**. Check that the charger status changes to **Charging**.
7. After charging is completed, pull out the charging connector.



If the charger status shows **Unplugged**, the charging connector may not be plugged into the EV correctly. In this case, check the connection, or pull out and plug the charging connector in again.

Stop Charging

1. Tap **Stop charging** during the charging process.
2. Check that the charger status changes to **Charging complete**.



You can start or stop charging on the App or using a charging card. Please start or stop charging in the same way for the same complete charging session.

9.5.1 ECO Charging

ECO charging is the most economical charging mode. In this mode, the system supplies other loads first with PV output and, when there is excess feed-in power, directs the charger to charge the EV. If the PV output power cannot meet the charging demand, the system uses energy stored in the battery for the charger. If the battery capacity is insufficient, the system purchases energy from the grid to cover the charging demand.

Procedure

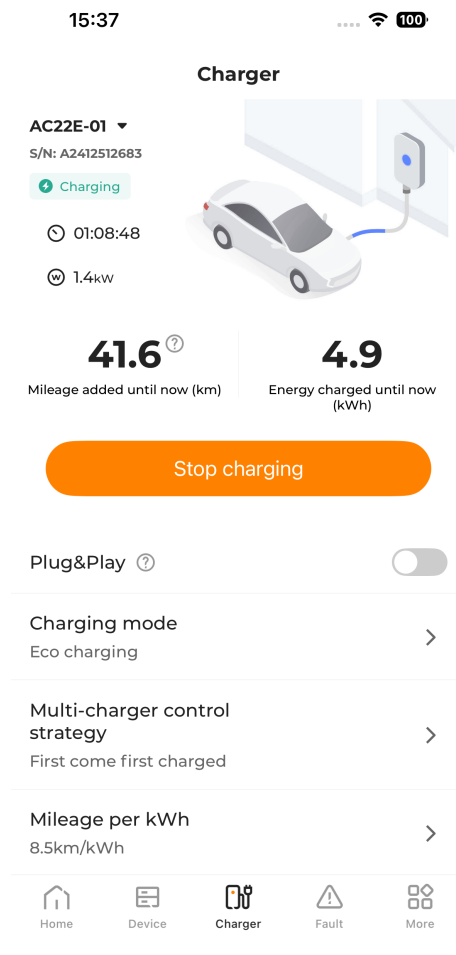

1. Go to the **Charger** page.
2. Enable or disable **Plug&Play** as needed.
 - Enable: Charging begins once the charging connector is plugged into the EV.

- Disable: Charging begins when the user taps **Start charging** after the charging connector is plugged into the EV.
3. Tap **Charging mode**, check **ECO charging**, complete the settings for **Energy purchase** and **Discharge prohibition SOC threshold**, then tap **Confirm**.

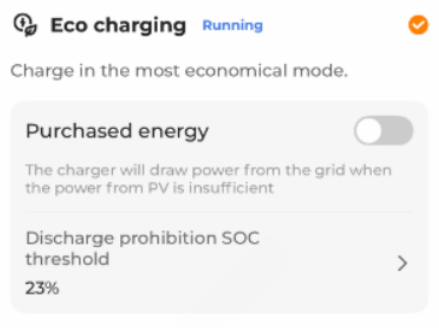

- a. Enable or disable **Energy purchase** as needed.
- Enable: The default option. When the PV output and battery energy are insufficient, the EV can be charged with energy purchased from the grid.
 - Disable (Default): Charging EVs with energy purchased from the grid is not allowed.
- b. Set the **Discharge prohibition SOC threshold**. It can be set only when **Energy purchase** is disabled.
- If the PV output power is not sufficient for the charger to work, battery energy is used to serve the charger. The rules are:
- The battery is allowed to discharge to supply the charger when the system SOC is above this threshold.
 - The battery is not allowed to discharge to supply the charger when the system SOC is below this threshold.

 The charging mode will be applied to all chargers under this plant.

4. In the **Multi-charger control strategy** drop-down list, select a multi-charger control strategy to distribute power across chargers based on the preset strategy to meet the varying demands of different users. The default option is First come first charged. Up to 3 chargers can be connected.
- **First come first charged**: The default option. Based on charger sequence and grid power limits, allocate power according to EV needs, prioritizing earlier-sequence EVs for quicker charging.
 - **Power distributed evenly**: Allocate charging power evenly according to the quantity of EVs and grid power limits.

 This function is available on iHomeManager-SV930.001.00.P013 or later.

5. Tap and set **Mileage per kWh**. This parameter indicates how far a vehicle can travel on 1kWh of energy and depends on the actual road conditions, the vehicle model, the weight of the vehicle and its load, and the speed of the vehicle.

You can start charging once the settings are completed.



If the EV supports both three-phase and single-phase charging, the iHomeManager will instruct the three-phase charger to switch between single-phase and three-phase charging modes to enhance clean energy utilization. When the charging power falls within the range of 1.38–4.14 kW, the charger switches to single-phase charging mode; when the charging power rises above 4.14 kW again, the charger switches back to three-phase mode. A temporary power drop to 0 W during this transition is normal.

9.5.2 Fast Charging

In the Fast charging mode, the charger charges the EV at the maximum available power. Users can select this mode to get the EV ready quickly in case of an urgent travel need. In this mode, when the PV output is not sufficient to meet the charging demand, the system supplies energy stored in the battery to the charger. If the battery capacity is insufficient, the system purchases energy from the grid to cover the charging demand.

Procedure

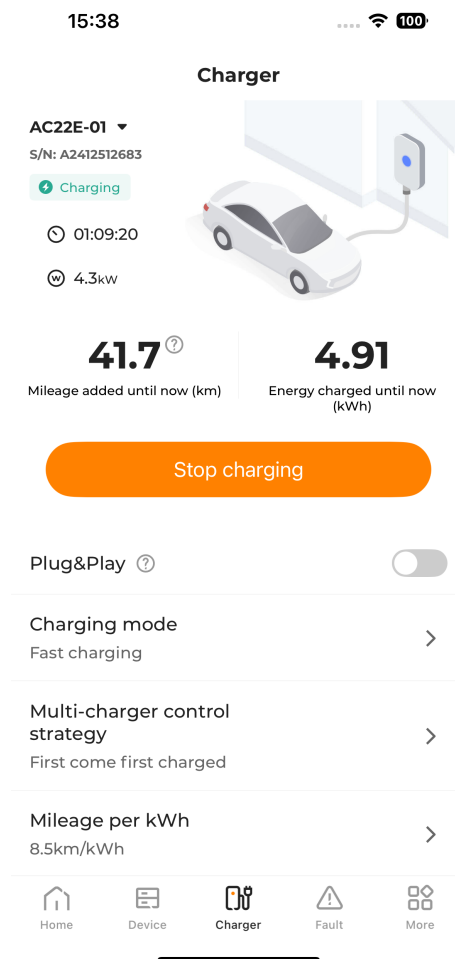

1. Go to the **Charger** page.
2. Enable or disable **Plug&Play** as needed.
 - Enable: Charging begins once the charging connector is plugged into the EV.
 - Disable: Charging begins when the user taps **Start charging** after the charging connector is plugged into the EV.
3. Tap **Charging mode**, select **Fast charging**, and tap **Save**.



The charging mode will be applied to all chargers under this plant.

4. In the **Multi-charger control strategy** drop-down list, select a multi-charger control strategy to distribute power across chargers based on the preset strategy to meet the varying demands of different users. The default option is First come first charged. Up to 3 chargers can be connected.
 - **First come first charged:** Based on charging sequence and grid power limits, allocate power according to EV needs, prioritizing earlier-sequence EVs for quicker charging.

- **Power distributed evenly:** Allocate charging power evenly according to the quantity of EVs and grid power limits.



This function is available on iHomeManager-SV930.001.00.P013 or later.

5. Tap and set **Mileage per kWh**. This parameter indicates how far a vehicle can travel on 1kWh of energy and depends on the actual road conditions, the vehicle model, the weight of the vehicle and its load, and the speed of the vehicle.

You can start charging once the settings are completed.

9.5.3 Scheduled Charging

In the Scheduled charging mode, based on the setting of **Charging target** and **Need to use vehicle at**, the system automatically switches between ECO charging and Fast charging, and completes charging at the minimum electricity cost before the user picks up the car.



Charging target sets the amount of energy expected to be delivered to the EV, without considering the remaining available energy in the EV battery.

Procedure

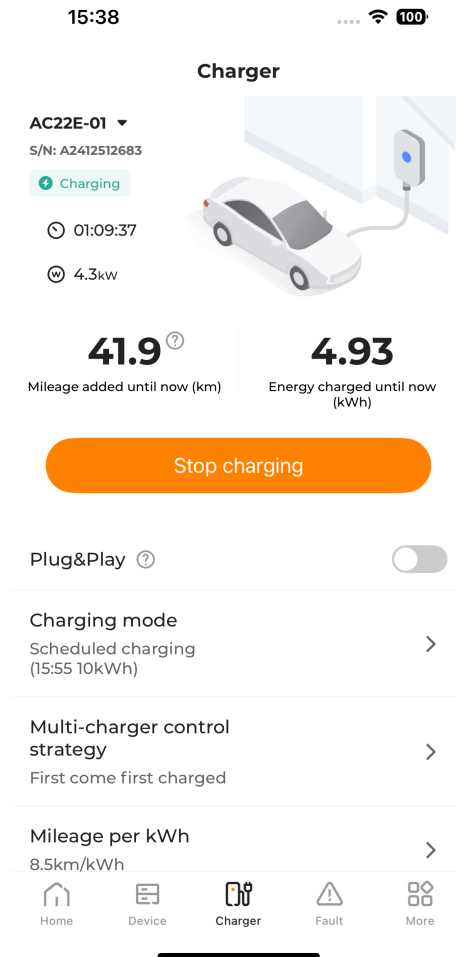

1. Go to the **Charger** page.
2. Enable or disable **Plug&Play** as needed.
 - Enable: Charging begins once the charging connector is plugged into the EV.
 - Disable: Charging begins when the user taps **Start charging** after the charging connector is plugged into the EV.
3. Tap **Charging mode**, check **Scheduled charging**, complete **Charging target** and **Need to use vehicle at**, then tap **Confirm**.



- Charging will stop once the **Charging target** is reached, even if the **Need to use vehicle at** has not yet arrived.
- The screen will display **Unable to complete the charging target before you pick up the vehicle** if the charger cannot meet the **Charging target** before the pickup time set in **Need to use vehicle at**. Tap **Confirm** to save the above settings. Tap **Cancel** to go back to **Add preset conditions** and set the parameters again.

i The charging mode will be applied to all chargers under this plant.

- In the **Multi-charger control strategy** drop-down list, select a multi-charger control strategy to distribute power across chargers based on the preset strategy to meet the varying demands of different users. The default option is First come first charged. Up to 3 chargers can be connected.
 - **First come first charged**: Based on charging sequence and grid power limits, allocate power according to EV needs, prioritizing earlier-sequence EVs for quicker charging.
 - **Power distributed evenly**: Allocate charging power evenly according to the quantity of EVs and grid power limits.

i This function is available on iHomeManager-SV930.001.00.P013 or later.

- Tap and set **Mileage per kWh**. This parameter indicates how far a vehicle can travel on 1kWh of energy and depends on the actual road conditions, the vehicle model, the weight of the vehicle and its load, and the speed of the vehicle.

You can start charging once the settings are completed.

9.5.4 Customized Charging

The Customized charging mode allows users to define the start time and end time for a charging task and the charging **Current/Power**. In this mode, when the PV output is not sufficient to meet the charging demand, the system supplies energy stored in the battery to the charger. If the battery capacity is insufficient, the system purchases energy from the grid to fulfill the charging demand.

Procedure

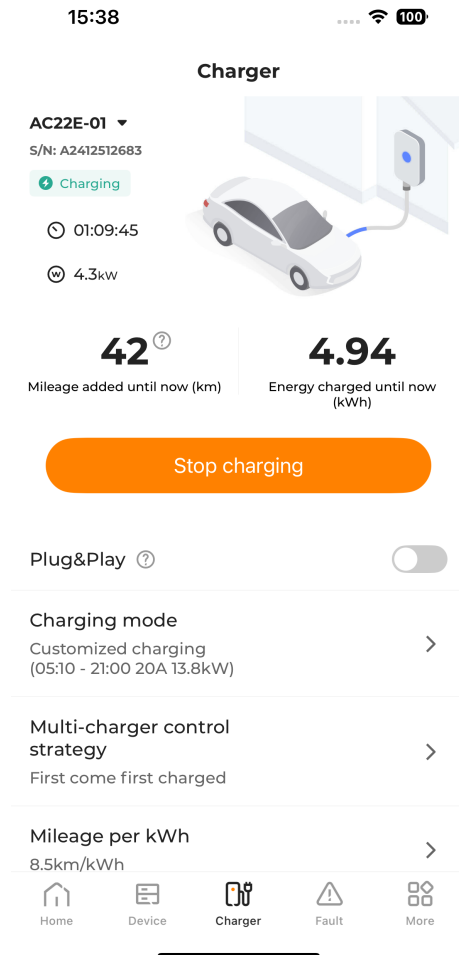

1. Go to the **Charger** page.
2. Tap **Charging mode**, check **Customized charging**, complete **Start and end time** and **Current/Power**, then tap **Confirm**.

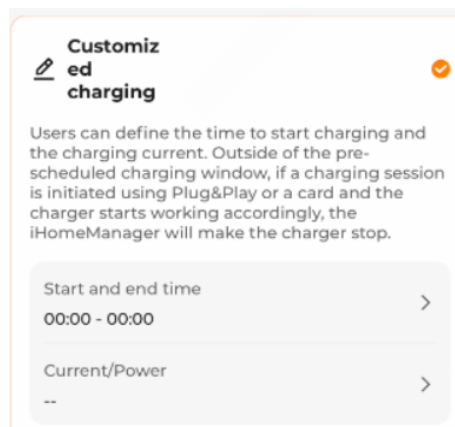

 The charging mode will be applied to all chargers under this plant.

3. In the **Multi-charger control strategy** drop-down list, select a multi-charger control strategy to distribute power across chargers based on the preset strategy to meet the varying demands of different users. The default option is First come first charged. Up to 3 chargers can be connected.
 - **First come first charged:** Based on charging sequence and grid power limits, allocate power according to EV needs, prioritizing earlier-sequence EVs for quicker charging.
 - **Power distributed evenly:** Allocate charging power evenly according to the quantity of EVs and grid power limits.

 This function is available on iHomeManager-SV930.001.00.P013 or later.

4. Tap and set **Mileage per kWh**. This parameter indicates how far a vehicle can travel on 1kWh of energy and depends on the actual road conditions, the vehicle model, the weight of the vehicle and its load, and the speed of the vehicle.

-  In this mode, the charger will charge the EV automatically within the preset time period.
- If the current time falls within the set charging window and the charging connector has been plugged into the socket on the EV, charging will begin immediately after you tap **Save**.
 - Outside of the customized charging window, if a charging session is initiated using Plug & Play or a card and the charger starts working accordingly, the iHomeManager will automatically cut off power to the charger to make it stop.

9.6 Energy Management by iHomeManager

The system provides various energy management modes to ensure effective energy management and maximization of energy utilization.

The following working modes are available for the iHomeManager.

- Self-consumption
- Time Plan
- Forced Mode
- AI Mode

 iHomeManager supports third-party scheduling. When the Third-party scheduling mode is selected, the Energy management page displays a message indicating that the system is currently operating in External energy dispatch mode, the plant dispatch is controlled by a third party, and users can manually switch to other modes.

9.6.1 Self-Consumption

The **Self-consumption** mode maximizes the utilization of PV output and battery energy to power the loads, thus minimizing grid energy consumption. Users can configure time windows for Feed-in Peak Power and Peak Shaving Limit based on electricity rates, allowing for flexible adjustment of battery charging/discharging and energy purchase strategies to optimize energy costs.

Function Logic

- When the PV output power is sufficient, the PV energy will be first supplied to the loads, with the excess stored in the battery. If, after this, there is still energy surplus, it will be fed into the grid.
- If the PV output power is insufficient to meet the load demand, the system discharges the battery to compensate. If the battery capacity is insufficient, the system draws power from the grid to meet the load demand.

Procedure

The screenshot displays the 'Self-consumption' configuration screen. At the top, the time is 16:06 and the battery level is 54%. The title is 'Self-consumption'. Below the title, there is a toggle for 'Peak shaving mode' which is turned on. Underneath, 'Reserved SOC for peak shaving(%)' is set to 0, with a range of [0-100]. A section for time windows is shown with a dropdown for 'Jan to Mar' and 'Working days & non-working days'. The 'Working days' tab is selected. At the bottom, there are two graphs: 'Peak shaving limit' and 'Feed-in peak power'. The 'Feed-in peak power' graph shows a blue bar from 00:00 to 24:00 with a power of 0.00kW. A 'Save' button is at the bottom.

1. Choose **More > Energy management**.
2. Select **Self-consumption** and tap **Advanced settings**.
3. Enable or disable the **Peak Shaving Mode**. The mode is disabled by default.
4. If **Peak Shaving Mode** is enabled, enter a value in **Reserved SOC for Peak Shaving (%)**.



The Reserved SOC for Peak Shaving must be greater than the Reserved battery SOC for off-grid. Otherwise, the setting will not take effect.

5. Configure the time windows for **Feed-in Peak Power** and **Peak Shaving Limit**. See [9.6.1.2 Custom Month Span](#) for details.
6. Set the **Feed-in Peak Power** and **Peak Shaving Limit**. See [9.6.1.1 Demand Control](#) for details.
7. Tap **Save**.

9.6.1.1 Demand Control

Demand control allows you to set the **Feed-in Peak Power** and **Peak Shaving Limit**. In the **Self-consumption** mode, after the demand control parameters are set, the battery charging/discharging strategy will adjust automatically based on the energy purchasing and feed-in power, thus improving the economic benefits of clean energy.

Feed-in Peak Power

After you configure this threshold, when there is sufficient sunlight, the system will meet the load demand with PV energy first and feed the excess into the grid. The battery will only be charged when the power feed-in exceeds this threshold. When the battery is fully charged, the system will limit PV generation or grid feed-in based on the configured Feed-in limit power.

Peak Shaving Limit

After you configure this threshold, when there is insufficient sunlight: If the battery has sufficient charge, the system will prioritize supplying power to the load from the battery. If the battery charge is insufficient, the system will draw power from the grid to supply the load. When the energy purchase power exceeds this threshold, the system will continue to draw power from the battery for load use, helping reduce the user's electricity cost.

Procedure

1. In the **Feed-in Peak Power** column, click an existing time window. In the pop-up **Feed-in Peak Power** dialog box, enter the demand feed-in power upper limit (range: 0–600 kW). Tap **Confirm**.

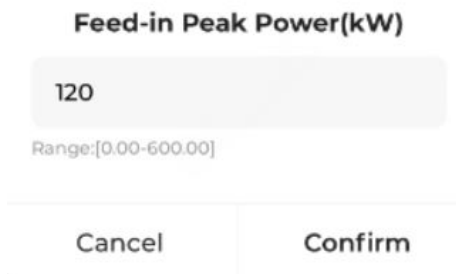

- In the **Peak Shaving Limit** column, click an existing time window. In the pop-up **Peak Shaving Limit** dialog box, enter the demand purchase power upper limit (range: 0–600 kW). Tap **Confirm**.



Example

Given the inverter PV installed power is 10 kW, the inverter rated power is 10 kW, the maximum charging/discharging power of the battery is 5 kW, and the battery backup SOC is set to 70%.

Set the **Peak Shaving Limit** to 2 kW. Then, in case of insufficient sunlight, the energy allocation in the system is as follows:

- If the PV output power is 2 kW, the consumption of the load is 4 kW, and the battery backup SOC is 90%: The load prioritizes drawing power from the battery. At this time, the battery discharging power is 2 kW.
- If the PV output power is 2 kW, the consumption of the load is 5 kW, and the battery backup SOC is 50%: Due to the restriction of **Peak Shaving Limit**, the load imports a power of 2 kW from the grid, and the excess 1 kW is supplemented by battery discharge.

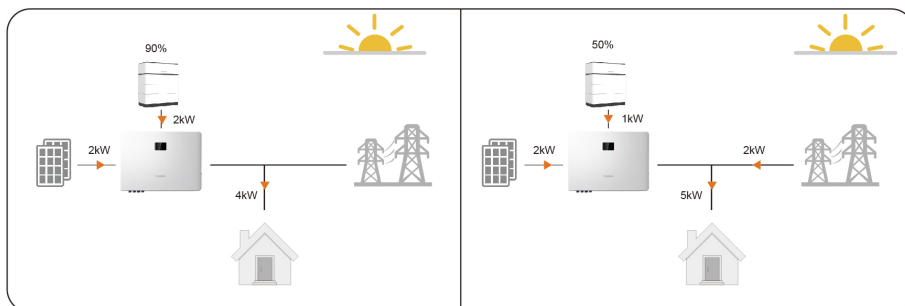

Set the **Feed-in Peak Power** to 3 kW. Then, under sufficient sunlight, the energy allocation in the system is as follows:

- If the PV output power is 4 kW, and the consumption of the load is 3 kW: As the excess 1kW has not exceeded the **Feed-in Peak Power**, the excess will be fed into the grid, instead of being used to charge the battery.
- If the PV output power is 7 kW and the consumption of the load is 2 kW, due to the restriction of **Feed-in Peak Power**, 3 kW will be fed into the grid and the remaining 2 kW will be used to charge the battery.

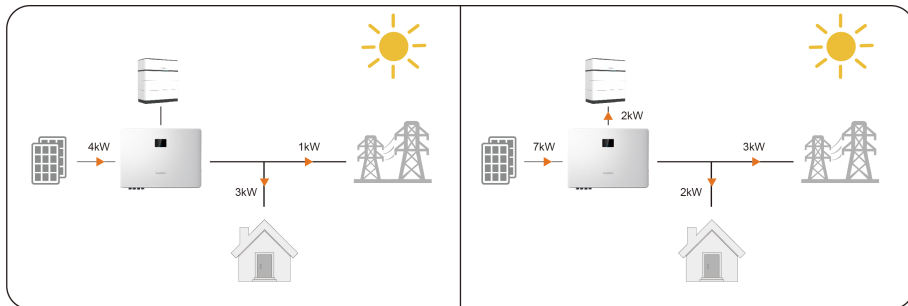

9.6.1.2 Custom Month Span

In the **Self-consumption** mode, users can set battery charging/discharging plans to optimize the energy usage and management. With properly set time windows for Feed-in Peak Power and Peak Shaving Limit, the system maximizes the use of PV output during on-peak hours and reduces the energy purchased from the grid during off-peak hours, thus lowering the electricity costs.

Time Window Status	Description
<div style="background-color: #004a99; color: white; padding: 2px;">00:45-01:45</div> <div style="background-color: #004a99; color: white; padding: 2px; font-size: 0.8em;">Power:0kW</div> : Feed-in Peak Power	If the time window is displayed in a dark color, you can drag up and down to adjust its length, to a minimum of 15 minutes.
<div style="background-color: #004a99; color: white; padding: 2px;">00:00-01:15</div> <div style="background-color: #004a99; color: white; padding: 2px; font-size: 0.8em;">Power:0kW</div> : Peak Shaving Limit	
<div style="background-color: #add8e6; color: black; padding: 2px;">00:00-01:00</div> <div style="background-color: #add8e6; color: black; padding: 2px; font-size: 0.8em;">Power:100kW</div> : Feed-in Peak Power	If the time window is displayed in a light color, it indicates that the Feed-in Peak Power or Peak Shaving Limit has been set for this period of time. You can tap and delete the window.
<div style="background-color: #add8e6; color: black; padding: 2px;">01:00-02:00</div> <div style="background-color: #add8e6; color: black; padding: 2px; font-size: 0.8em;">Power:100kW</div> : Peak Shaving Limit	

Procedure

1. In the time window configuration area, set the desired month span. You can set different time windows based on seasonal energy demand patterns.
2. Select the days on which the **Feed-in Peak Power** or **Peak Shaving Limit** plan applies. You can apply the plan to all days, or set different plans for weekdays and weekends. The plan applies to every day by default.

- **Every day:** The set **Feed-in Peak Power** and **Peak Shaving Limit** plan applies on all days. This option is ideal for scenarios where the daily energy demand is relatively stable.
 - **Weekdays & weekends:** Set different **Feed-in Peak Power** and **Peak Shaving Limit** plans for weekdays and weekends.
3. To add more month spans, tap  to the right of the default month span name and select **Add**.



You can select a month span and tap  to modify its name or delete it.

4. Tap the desired time period in the **Feed-in Peak Power** or **Peak Shaving Limit** column. A new Feed-in Peak Power or Peak Shaving Limit time window will be created. Then, drag up and down to adjust the length of time, and tap the window again to add it.



Feed-in Peak Power and **Peak Shaving Limit** time windows can overlap.

9.6.2 Time Plan

The **Time plan** mode is mainly used in electricity transaction scenarios. You can set the time windows and power for battery charging/discharging manually, according to the on- and off-peak electricity prices, to maximize the economic benefits.

It is recommended to allow the battery to discharge during on-peak hours (when electricity prices are higher) and charge during off-peak hours (when electricity prices are lower).

Function Logic

- Discharging window: The battery discharges at the predefined discharging power within the set time period until the Battery discharge target SOC is reached.
- Charging window: The battery charges at the predefined charging power within the set time period. If PV power is sufficient, the battery charges until it is fully charged. If PV power is insufficient, it charges until the Battery charge target SOC is reached.

Procedure

16:07 ... 54%

Time plan

Battery charge target SOC(%)

100

Range:[0-100]

Battery discharge target SOC(%)

0

Range:[0-100]

Perform self-consumption in remaining time ?

TI ⋮

Jan to Mar ▼

Every day ▼

Discharge Charge

00:00 _____

01:00 _____

Save

1. Choose **More > Energy management**.
2. Select **Timed plan** and tap **Charge/discharge plan**.
3. Set the **Battery charge target SOC (%)**: Charging stops when the battery reaches the target charging SOC.
4. Set the **Battery discharge target SOC (%)**: Discharging stops when the battery drops to the target discharging SOC.
5. Enable **Perform self-consumption in rest time**. When enabled, the system performs self-consumption outside the defined charging/discharging time windows.
6. Set the desired month span. You can set different time windows based on seasonal energy demand patterns.
7. Select the days on which the battery charging/discharging plan applies. You can apply the charging/discharging plan to all days, or set different charging/discharging plans for weekdays and weekends. The plan applies to every day by default.
 - **Every day**: The set charging/discharging plan applies on all days. This option is ideal for scenarios where the daily electricity price is relatively consistent.

- **Weekdays & weekends:** Set different charging/discharging plans for weekdays and weekends.
8. To add more month spans, tap  to the right of the default month span name and select **Add**.



You can select a month span and tap  to modify its name or delete it.

9. Tap a time period in the **Discharge** or **Charge** column, a new discharging or charging window will be created. Then, drag up and down to adjust the length of time, and tap the window again to add it.



The charging and discharging windows cannot overlap.
The battery will not discharge in a time period with no settings. If the PV output is insufficient to meet the load demand, the system purchases energy from the grid to meet the load demand, and allows the battery to charge from the excess PV energy.

10. Tap an added window, choose **Set power**, and set the discharging or charging power.
11. Tap **Save**.

9.6.3 Forced Mode

The **Forced mode** is mainly used in battery O&M to control the battery and make it operate in compliance with the preset charging/discharging mode and power. Restore the system to the previous working mode after maintenance work is completed.

Function Logic

- **Forced Charging:** The battery charges at the preset charging power until it is fully charged.
- **Forced Discharging:** The battery discharges at the preset discharging power until it is fully discharged.
- **Stop:** The battery stops charging and discharging according to the preset stop charging and discharging mode.

Steps

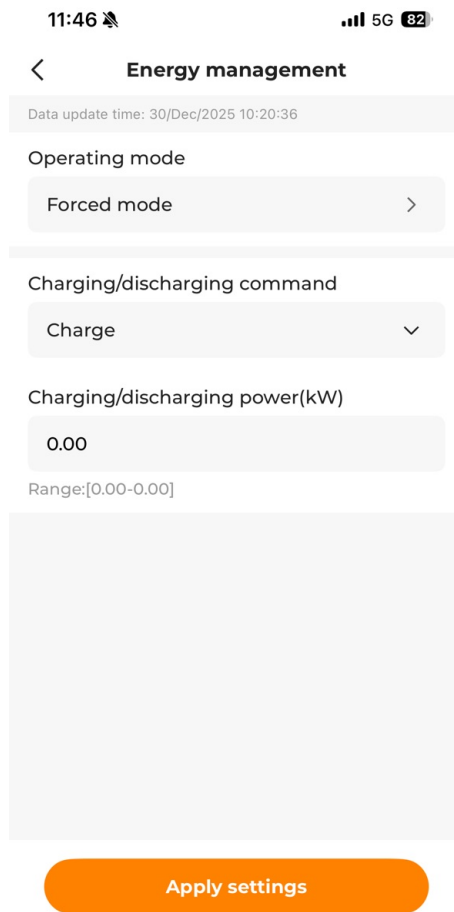

1. Choose **More > Energy Management**.
2. Select **Forced mode** and tap **Charge/discharge settings**.
3. Set the **Charging/Discharging Command**.
 - **Charge**: Force the battery to charge at the preset charging power until the battery SOC upper limit is reached.
 - **Discharge**: Force the battery to discharge at the preset discharging power until the battery SOC lower limit is reached.
 - **Stop**: Stop battery charging or discharging manually.
4. If **Charge** or **Discharge** is selected, set the target charging or discharge power in **Charging/Discharging Power**.
5. Tap **Save**.

9.6.4 AI Mode

In the **AI Mode**, the system predicts future PV yield and household electricity use, based on the meteorological data and the user's consumption profile. It then decides on an optimal

strategy to control battery charging/discharging and electricity usage in the household, thus maximizing the clean energy usage or the revenue.



A certain amount of data accumulation is required for AI mode to predict future production and consumption more accurately.

Steps

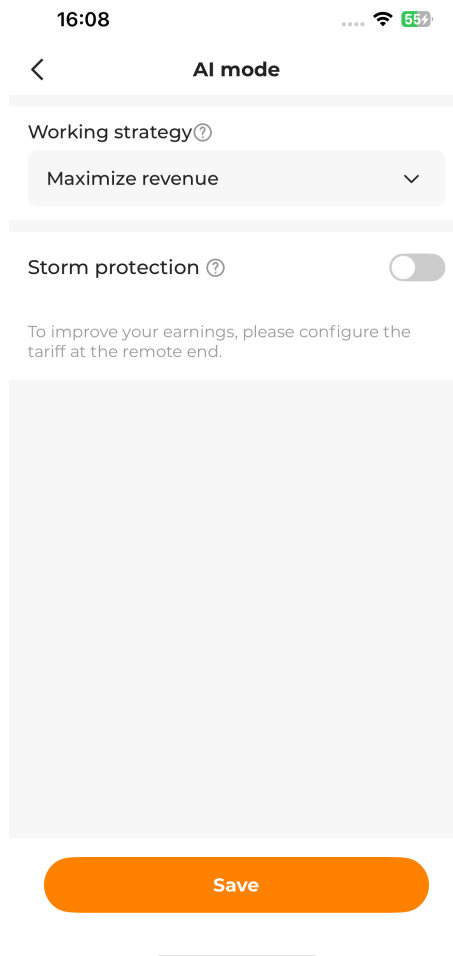

1. Choose **More > Energy Management**.
2. Select **AI Mode** and tap **AI performance**.
3. Set **Working Strategy** to **Maximize revenue** or **Maximize PV energy usage**. See [9.6.4.1 Maximize Revenue](#) and [9.6.4.2 Maximize PV Energy Usage](#) for detailed instructions.
4. Turn on or off **Storm Protection** as needed.
 - If the **Storm Protection** is enabled, upon receiving an extreme weather alert, the system charges at maximum capacity until reaching the SOC upper limit, ignoring all

the preset restrictions. When the extreme weather ends, the system will go back to the previous working mode.

- **Disable:** The system will work as per the set working strategy.

5. Tap **Save**.

9.6.4.1 Maximize Revenue

Function Logic

By analyzing the meteorological data, the system controls the charging/discharging of the battery properly based on PV yield forecast, electricity price settings, and loads' energy consumption, to cover the user's energy demand and reduce the consumption of energy from the grid.



The meteorological data comes from official statistics.

Requirements

Tariff settings have been completed. For detailed instructions, see [9.4.5 Create Plant](#).

Steps

1. In the **Working Strategy** drop-down list, select **Maximize Revenue**.

9.6.4.2 Maximize PV Energy Usage

Function Logic

After the load connected to the device is added and the rated power and work time of the load are set, the system maximizes the use of PV output and battery energy to supply the load and reduces the energy purchased from the grid.

Steps

1. In the **Working strategy** drop-down list, select **Maximize PV energy usage**.



Maximizing PV energy usage will switch the local smart load that supports AI mode to ECO mode.

9.6.4.3 View Energy Analysis Curve Results

After completing the AI mode setup, you can view the AI-driven energy analysis curve data by accessing the Overview page of the plant on the App.



This function is available on iHomeManager-SV930.001.00.P008 or later.

1. Log in to the App, choose a plant, and go to "Overview".
2. Tap  next to **AI mode** to view the AI-driven energy analysis curve data.



No.	Definition	Description
1	Time period switching	By default, you can view the analysis curve data for the current day. You can switch the time period to view tomorrow's forecast curve data.
2	Power data	View the power data of the following items based on the curve color: <ul style="list-style-type: none"> • PV • Tariff • Battery • Charger • Load
3	Battery working strategy	You can view the battery working strategies corresponding to different time on the curve.

No.	Definition	Description
		<ul style="list-style-type: none"> • Charge • Discharge • Self-consumption
4	Battery data	Display actual and predicted battery charging/discharging strategies and SOC values.
5	Load operating hours	Display the AI-recommended load operating periods.

9.7 Power Control

9.7.1 DI Power Regulation

DI power regulation supports Ripple Control and EnWG 14a control. If an emergency stop device is connected, users can also configure the emergency stop function.



If the DI power regulation is not needed, set **DI Control Method** to "OFF".

9.7.1.1 Ripple Control

In the "Ripple Control" mode, the system receives control signals from the grid in the form of dry contact signals, and perform power regulation as required.

If the "Ripple Control" mode is selected, the grid operator will convert the grid schedule signal into the dry contact signal and send it out. A total of 16 DI combinations are available, each with a specific power ratio. Please set the DI combination for the system so that it can receive and respond to grid signals properly.

Table 9-1 DI Interface Status

Icon	Description
	This DI interface is in the open state.
	This DI interface is in the closed state.



DI combinations cannot be repeated.

Steps

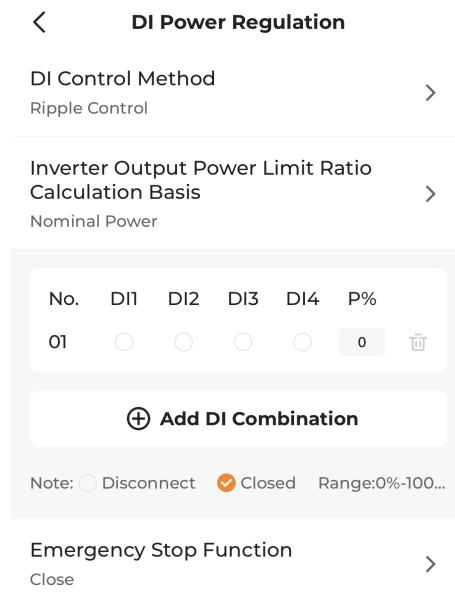

1. Choose **More > Power Control > DI Power Regulation**.
2. Set the **DI Control Method** to **Ripple Control**.
3. Set the **Inverter Output Power Limit Ratio Calculation Basis**.
 - **Nominal Power**: The value of the schedule command is calculated based on the rated power of the inverter that is connected.
 - **Installed PV Power**: The value of the schedule command is calculated based on the installed PV power of the inverter that is connected. Please enter the **Total Installed Power of Modules** based on the actual plant conditions.
4. Select DI ports, and set a power ratio in a range of 0%–100%.

 Set DI combinations based on the control signals sent from the grid operator.

Example

If the control signal received is converted into the DI combination of 1100, which indicates a power limit ratio of 80%, set as follows:

No.	DI1	DI2	DI3	DI4	P%
01	<input checked="" type="checkbox"/>	<input checked="" type="checkbox"/>	<input type="checkbox"/>	<input type="checkbox"/>	80

5. Tap **Add DI Combination** to add other DI combinations.
6. Tap **Apply Settings**.

9.7.1.2 Control via EnWG 14a

- This function is available on iHomeManager-SV930.001.00.P008 or later.
- When the EnWG 14a mode is selected, iHomeManager applies a battery charging power limit to the entire system. Even if emergency charging is triggered, the battery charging power drawn from the grid cannot exceed 4.2 kW.
- After enabling the EnWG 14a mode, the control strategies for chargers and heat pumps are automatically disabled. After disabling the EnWG 14a mode, the charger and heat pump control strategies will resume based on their previous settings.
- The **Close**, **Ripple control**, and **EnWG 14a** DI control methods are mutually exclusive.

Procedure

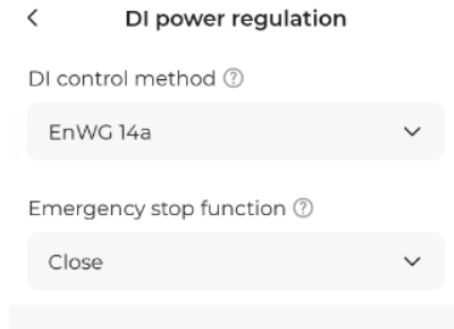

1. Choose **More > Power control > DI power regulation**.
2. Set the **DI control method** to **EnWG 14a**.
3. Tap **Apply settings**.

9.7.1.3 Emergency Stop Function

The emergency stop function allows users to stop the inverter immediately in case of an emergency.

- The emergency stop function is available for SUNGROW inverters only.

Table 9-2 Emergency Stop Modes

Mode	Description
OFF	Emergency stop control is disabled.
Stop Inverter	When emergency stop is triggered, the inverter enters the emergency stop state.

Steps

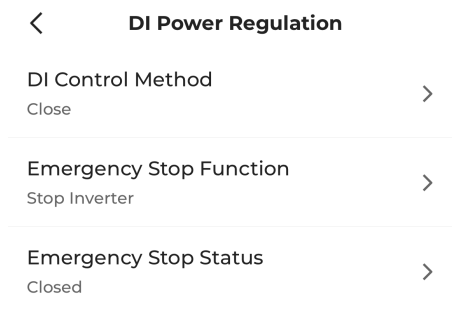

1. Choose **More > Power Control > DI Power Regulation**.
2. Open the **Emergency Stop Function** drop-down list. You can decide whether to enable the emergency stop function and select the emergency stop mode based on actual needs.
3. If **Stop Inverter** is selected, select a trigger condition in the drop-down list of "Emergency Stop Status".
 - **Open**: Emergency stop will be triggered when DI opens.
 - **Closed**: Emergency stop will be triggered when DI closes.
4. Tap **Apply Settings**.

9.7.2 Grid-Connected Power Control

Energy management mode allows users to set limits on energy purchase and feed-in power.

Procedure

1. Choose **More > Power control > Grid-connected power control**.
2. In the **Energy purchase control method** drop-down list, select **No limit** or **Purchase energy with limited power**.
 - **No limit**: There is no power limit for purchasing energy from the grid.
 - **Purchase energy with limited power**: There is a power limit for purchasing energy from the grid.
3. If **Purchase energy with limited power** is selected, set a proper power limit in **Power limit for energy purchase (kW)** based on the rated current of the main power source equipment (e.g., household air circuit breaker) that is connected to the system.



The value **Power limit for energy purchase (kW)** cannot be lower than the total load connected in the system.

4. In the **Feed-in control method** drop-down list, select one of the following options:



- **Total active power unlimited:** The total feed-in power is not limited, allowing all the excess power to be transported to the grid.
- **Total active power feed-in limit:** The total feed-in power is limited, ensuring that the value does not exceed the upper limit.
- **Per-phase active power unlimited:** The feed-in power of each of the three phases is not limited, allowing free feed-in of the generated power within the per-phase independent capacity cap.
- **Per-phase active power feed-in limit:** The feed-in power of each of the three phases is limited, ensuring that the per-phase feed-in power does not exceed the upper limit.



The options **Per-phase active power unlimited** and **Per-phase active power feed-in limit** are available only in iHomeManager-SV930.001.00.P014 or higher.

5. If **Total active power feed-in limit** is selected, set a proper power limit in **Feed-in power limit** for energy feed-in according to the local laws and regulations. The default unit is %, and you can switch to kW.
6. If **Per-phase active power feed-in limit** is selected, define the power limit in **Phase A/B/C feed-in power limit** and choose the power unit of either % or kW.

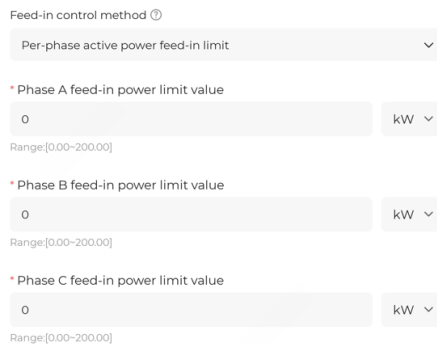

- When the unit **kW** is selected, set a proper feed-in power value based on local laws and regulations.
- When the unit **%** is selected, from the drop-down list **Feed-in power limit ratio calculation basis**, choose a basis for limiting the grid-connected power.
 - **Nominal power:** The dispatch value is calculated based on the rated power of the connected inverter.

- **Installed PV power:** The dispatch value is calculated based on the installed PV power of the connected inverter. Enter the total installed power of modules based on the actual plant conditions.
7. If **On** is selected in **Third-party power generation systems** (turned off by default), specify the rated power in **Rated power of third-party power generation system (kW)**.



This parameter is required if a third-party inverter is connected to the device.

8. Switch on or off **Ultra-fast grid dispatch mode** (enabled by default).



Enabling this mode allows faster active power regulation for the system. It is recommended to enable it in scenarios with reverse power protection or zero export control.

9. Click **Apply settings**.

9.8 Intelligent Load

The **Intelligent Load** allows users to define the working mode for a load and control how and when the load works. The following three working modes are available.

- Scheduled Mode
- Instant Mode
- ECO Mode

Steps

1. Choose **More > DO external device**.
2. Tap on a load and select a working mode for it. For details, see [9.8.1 Scheduled Mode \(Heat Pump Control\)](#), [9.8.2 Instant Mode \(Heat Pump Control\)](#) and [9.8.3 ECO Mode \(Heat Pump Control\)](#).
3. Go back to the **DO external device** screen, and turn on the target load. The load will then operate in compliance with the preset working mode.

9.8.1 Scheduled Mode (Heat Pump Control)

The **Scheduled Mode** allows the load to work in a specific time period. You can define the time for the load to start and stop working.

Steps

The screenshot shows a mobile application interface for configuring a load. At the top, the time is 16:36 and the battery level is 72%. The title bar shows a back arrow, the load name 'load2', and a trash icon. The configuration fields are as follows:

- * Load name:** A text input field containing 'load2'.
- * Nominal power(kW):** A text input field containing '1.0'. Below it, the range is specified as 'Range:[0.0-50.0]'.
- Operating mode:** A dropdown menu currently set to 'Scheduled mode' with a question mark icon.
- * Every day >:** A section for selecting days, with a prominent '+ Add period' button.
- Connection method:** A text input field containing 'DO2'.

At the bottom of the form is a large orange button labeled 'Apply settings'.

1. Select the target load. The **Load Name** and **Nominal Power** can be modified.
2. Set the **Operating mode** to **Scheduled Mode**.
3. Select the days on which the work plan applies.
You can apply the work plan to every day, or set different work plans respectively for weekdays and weekends. The work plan applies to every day by default.
 - **Every Day:** The work plan applies on all days. This mode is suitable for scenarios where the load usage is relatively stable.
 - **Weekdays & Weekends:** Set different work plans respectively for weekdays and weekends.
4. Tap **Add Time** and set the **Start Time** and **End Time** of each time window.

 Up to four time windows can be set, each with a minimum length of 30 minutes. The time windows cannot overlap.
5. Tap **Apply settings**.

9.8.2 Instant Mode (Heat Pump Control)

The **Instant Mode** allows the load to start or stop working immediately as per the commands. In this mode, you can start or stop an intelligent load as needed on the **Intelligent Load** screen.

Steps

The screenshot shows a mobile application interface for configuring a load named 'load2'. At the top, the time is 16:36 and the battery level is 72%. The screen has a back arrow on the left and a trash icon on the right. The configuration fields are as follows:

- * Load name:** A text input field containing 'load2'.
- * Nominal power(kW):** A text input field containing '1.0'. Below it, the range is specified as 'Range:[0.0-50.0]'.
- Operating mode:** A dropdown menu with a question mark icon, currently set to 'Instant mode'.
- Connection method:** A text input field containing 'DO2'.

At the bottom of the screen, there is a large orange button labeled 'Apply settings'.

1. Select the target load. The **Load Name** and **Nominal Power** can be modified.
2. Set the **Operating mode** to **Instant Mode**.
3. Tap **Apply settings**.

9.8.3 ECO Mode (Heat Pump Control)

The **ECO Mode** allows the loads to turn on and consume PV energy when the PV output power is sufficient, thus improving the self-consumption rate. In this mode, the system prioritizes supplying PV energy to other loads and, if there is excess feed-in power, turns on the intelligent load.

Steps

The screenshot shows a mobile application interface for configuring a load. At the top, the time is 16:36 and the battery level is 72%. The title bar shows a back arrow, the load name 'load2', and a trash icon. The configuration fields are as follows:

- * Load name:** A text input field containing 'load2'.
- * Nominal power(kW):** A text input field containing '1.0'. Below it, the range is specified as 'Range:[0.0-50.0]'.
- Operating mode (?):** A dropdown menu currently set to 'ECO mode'.
- Discharge prohibition SOC threshold(%) (?):** A text input field containing '5'. Below it, the range is specified as 'Range:[5-100]'.
- * Every day >:** A section header for scheduling.
- + Add period:** A button to add a new time period.
- Connection method:** A text input field containing 'DO2'.
- Apply settings:** A large orange button at the bottom to save the configuration.

1. Select the target load. The **Load Name** and **Nominal Power** can be modified.
2. Set the **Operating mode** to **ECO Mode**.
3. Set a lower-limit SOC threshold for discharging in **Lower SOC Limit of Discharging**, in a range of 5 to 100.
4. Select the days on which the work plan applies.
You can apply the work plan to every day, or set different work plans respectively for weekdays and weekends. The work plan applies to every day by default.
 - **Every Day:** The work plan applies on all days. This mode is suitable for scenarios where the PV power output is rather stable.
 - **Weekdays & Weekends:** Set different work plans respectively for weekdays and weekends.
5. Tap **Add Time** and set the **Start Time** and **End Time** of each time window.



Up to four time windows can be set, each with a minimum length of 30 minutes. The time windows cannot overlap.

6. Tap **Apply Settings**.

9.9 Device Settings

9.9.1 iHomeManager Settings

Basic Settings

Choose **More > iHomeManager Settings**, and select **Basic Settings** to set the parameters related to the iHomeManager.

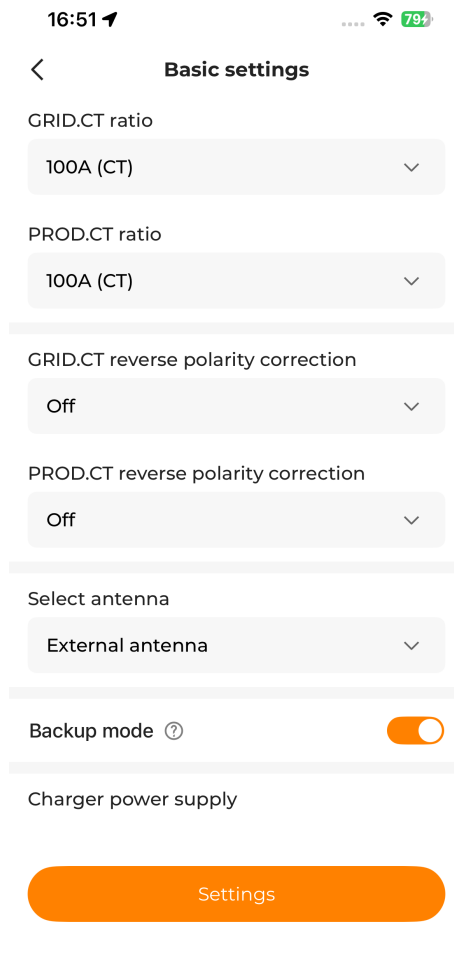

Table 9-3 Parameter Description

Parameter	Description
GRID.CT Ratio	Set the maximum current that the CT at the GRID.CT terminal can measure.
PROD.CT Ratio	Set the maximum current that the CT at the PROD.CT terminal can measure.
GRID.CT Reverse Connection Correction	This function is used to correct the polarity for data accuracy when the signal wires of the CT are connected in reverse. Correct wiring: Connect the white signal wire to "+" and blue wire to "-".
PROD.CT Reverse Connection Correction	Example If the white wire is connected to "-" and blue wire to "+" in phase A, select the option Phase A Reverse for reverse polarity correction.
Select Antenna	<ul style="list-style-type: none"> • Built-in Antenna: No external antenna is connected. • External Antenna: An external antenna is connected.
Backup Mode	Turn on this button and set the Reserved Battery SOC for Off-Grid if the device is in the backup mode.
Reserved Battery SOC for Off-Grid	Energy reserved for the off-grid operation of the system. It sets the minimum SOC to which the system can discharge in the grid-connected mode.
Automatic Recharge to Reserved Battery SOC for Off-grid	If this function is turned on, when the battery SOC is lower than of the Reserved Battery SOC for Off-Grid , the system starts an emergency battery charging until

Parameter	Description
	reaching the Reserved Battery SOC for Off-Grid .

Forwarding channel Settings

Choose **More > iHomeManager Settings**, and select **Forwarding channel Settings** to set the open status of the local port of the iHomeManager and the SSL encryption status.

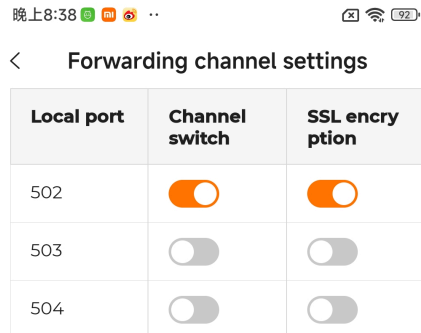

Apply settings



The function is supported in versions iHomeManager-SV930.001.00.P006 and above.
Local ports 502, 503 and 504 are Used to connect SUNGROW devices or third-party management systems to iHomeManager via Modbus Transmission Control Protocol (Modbus TCP). Port 502 is enabled by default and SSL encryption is enabled. Ports 503 and 504 are closed by default and SSL encryption is also disabled.

9.9.2 Inverter Grid-connection Settings

Choose **More > Inverter Settings**. Then, select the target inverter, and tap **Settings** to set the parameters for the inverter's connection to grid.



To configure parameters beyond the grid-connection parameters for the inverter, the WiNet-S/S2 is required. Please refer to the inverter's user manual for detailed instructions, as settings may vary by model.

9.10 Device List

You can view the general information about and manage the devices connected to the iHomeManager on the **Device** screen.

Device List

All(7) Inverter(2) Charger(1) Filter

Inverter1

▲ Fault >

SH25RT S/N: 12345678
Running Status : Forced Mode Operation

Daily Yield	Real-Time Power
20kWh	20kW

Associated Communication Device
S/N: A123456

Battery(1) >

Inverter2

● Normal

SH25RT S/N: 12345678
Running Status : Forced Mode Operation

Daily Yield	Real-Time Power
20kWh	20kW

Associated Communication Device
S/N: A123456

Home
Device
More

- **Device running data:** Check the inverter's power generation data, the signal strength of the communication device, the battery voltage, current, and SOC, the charger's charging power, and the energy delivered by the charger.
- **Associated devices:** Check the S/Ns of the communication device and battery associated with the inverter.

- **Device running status:** Check the running status of the inverter.
 - After the quick settings are completed and the devices can communicate with each other normally, the status of the hybrid inverter will be **Energy Dispatching Operation**, and that of the PV inverter will be **On-grid Operation**.

SH10T
 Normal
 Inverter S/N: A2360216258
 Running Status: Energy Dispatching Operation
 Daily Yield: 120.3kWh
 Real-time Power: 19.984kW
 Associated Communication Device S/N: A2340110625
 Battery(2)

SG5.0RT
 Normal
 Inverter S/N: A23A3004934
 Running Status: On-grid Operation
 Daily Yield: 30.1kWh
 Real-time Power: 0.323kW
 Associated Communication Device S/N: B2362610888
 Battery(2)

- If the hybrid inverter operates normally, while the PV voltage is too low and there is a fault in the battery or no battery is connected, the status of the hybrid inverter will be **Standby**.

SH10T
 Normal
 Inverter S/N: A2360216258
 Running Status: Standby
 Daily Yield: 0.0kWh
 Real-time Power: 0.000kW
 Associated Communication Device S/N: A2340110625
 Battery(2)

- If no battery is connected to the hybrid inverter, the status of the hybrid inverter will be **On-grid Operation**.

SH10T
 Fault >
 Inverter S/N: A2360216258
 Running Status: On-grid Operation
 Daily Yield: 0.0kWh
 Real-time Power: 0.323kW
 Associated Communication Device S/N: A2340110625
 Battery(2)

9.10.1 Add Device

In the **Device List** view, tap  in the upper right to go to **“Device Management”**. Automatic device search is supported. You can also add the device manually.

Requirements

- The device is correctly connected to the RS485 port of the iHomeManager.
- The communication module and the iHomeManager are connected to the same network.

Automatic device search

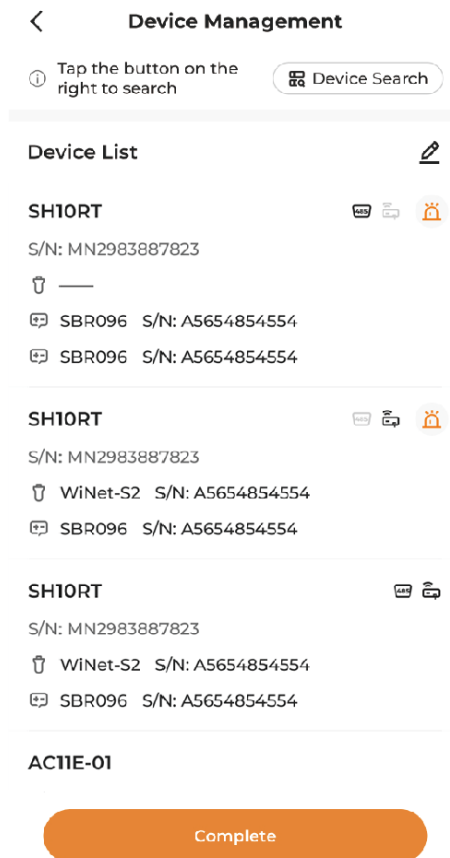

1. On the **Device Management** screen, tap **Device Search**.
2. After the device search is finished, verify that the devices in the list match the actual networked devices.
In case any device is missing, add it by following the instructions in [Add devices manually](#).
3. Tap **Complete**.



If a device has been added before but is not in the current search list, it will be deleted.

Add devices manually

On the **Device Management** screen, tap to go to the **Edit Device List** screen. Tap .

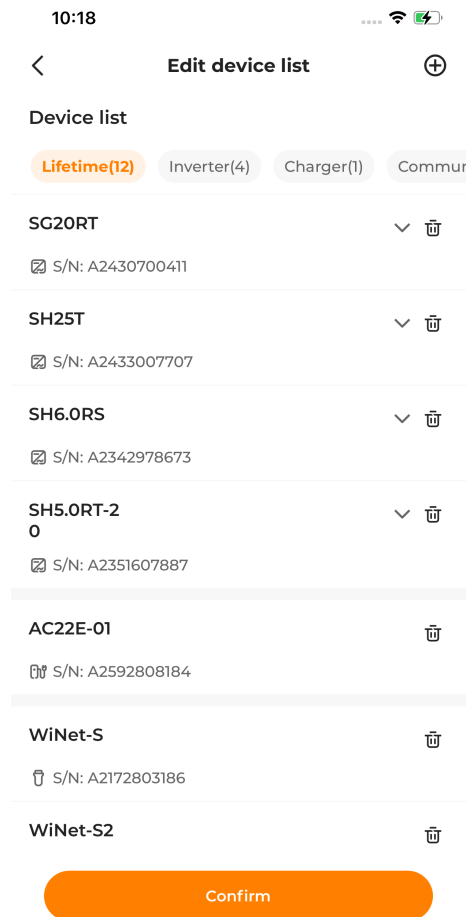

- Choose **Add Module**:
 1. Option 1: Scan the QR code on the communication device and tap **Confirm**.
 2. Option 2: Tap to upload a picture of the communication device's QR code and tap **Confirm**.
 3. Option 3: Tap , select the type of the communication device, enter the device S/N, and tap **Confirm**.
- Choose **Add Charger**:
Enter the charger S/N, and tap **Continue**.

9.10.2 Add Third-Party Device

Most household electrical appliances continue to consume power once they are switched on. When the power consumption of the devices exceeds the PV yield, the system will automatically purchase power from the grid to meet the demand. However, when there is surplus PV yield, these devices cannot be automatically turned on, thus failing to effectively utilize this clean energy.

iHomeManager, as the central hub of household energy management systems, can not only connect to chargers but also connect to more smart electrical appliances in the PV-ESS system, helping users adjust the working time or mode of devices more flexibly, as well as allocate power reasonably, increase the PV self-consumption rate, optimize electricity costs, and achieve smart household energy management. For household appliances that cannot communicate directly, they can be indirectly connected through smart switches.



This function is available on iHomeManager-SV930.001.00.P013 or later.



- Different manufacturers' devices may have different requirements for network connections. Specific requirements can be obtained by contacting the supplier.
- If the devices are connected to a router through WLAN, ensure that there is a stable WLAN signal for normal operation. Unstable signals may cause devices to fail to connect to the WLAN or frequently get disconnected.

9.10.2.1 Add Shelly Smart Plug

Preconditions

- Ensure that the connected smart switch is on the same router as the iHomeManager and is powered on.
- Ensure that the smart switch is within the WiFi range of the router, and that the network connection is stable.
- To connect multiple smart switches, it is recommended to add them one by one to avoid confusion. Up to 12 smart switches can be connected.



Currently, the only supported Shelly plug is Shelly Plug S MTR Gen3.

Procedure

1. Log in to the App, and tap the target plant. Select the **Device** tab.

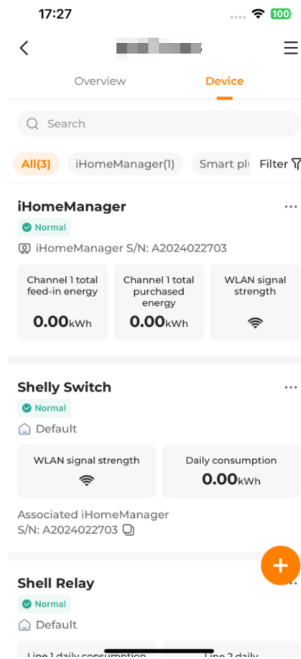

2. Tap . On the pop-up **Add device** page, tap the detected smart switch. Alternatively, you can manually add devices.

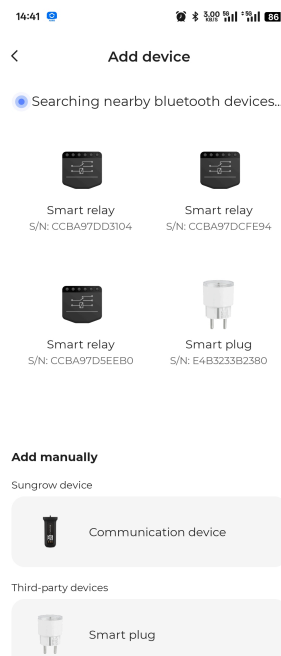

3. On the pop-up **Select home WiFi** page, choose a WiFi and enter the password. Tap **Next** to verify.

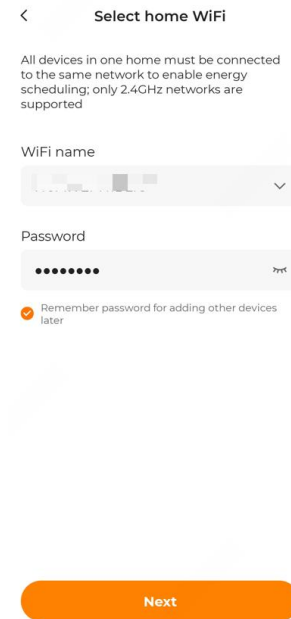

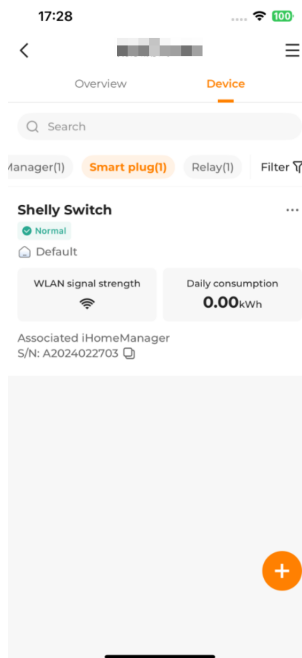

4. After successful adding, return to the **Device** tab to view the added device.



To facilitate future use and management, it is recommended to set the name of the smart switch as the name of the connected electrical appliance. Tap **...** on the left side of the device to customize the device name.

5. Tap the added smart switch to view Daily consumption, Total consumption, and Consumption power of the household appliance connected to the smart switch. Tap

Tap  to turn on or off the household appliance connected to the smart switch. Tap  in the upper-right corner to view the device details or delete the device.

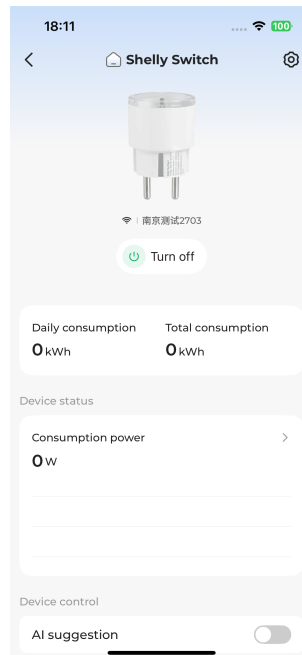

6. Tap **Consumption power** to view the daily consumption on the pop-up page, and enable or disable **Consumption**.

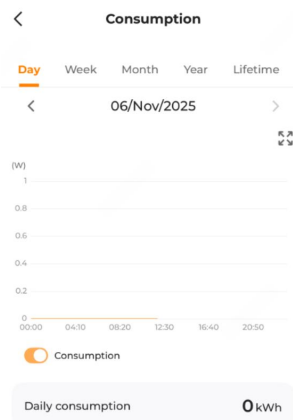

7. Enable **AI suggestion** (disabled by default). On the pop-up **Preset guide** page, set **Nominal power** and **Single-use duration**, and select a Usage cycle preference. Options include Recommended and Custom. Tap **Next**.

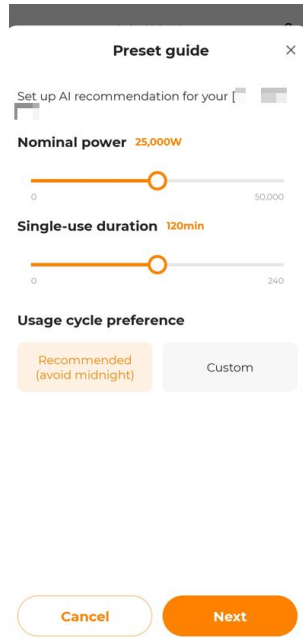

8. On the pop-up **Create time plan** page, set the Start time, End time, and repeat days, then tap **Save**.

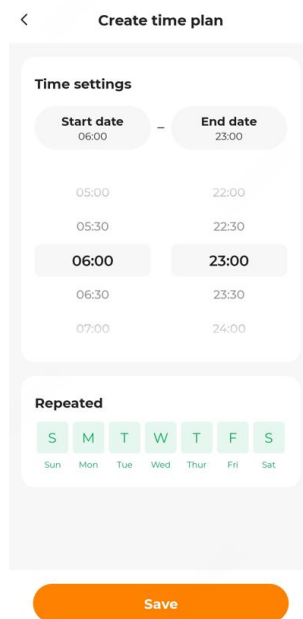

9. On the pop-up **Active period** page, you can modify, delete, and create multiple time plans, then tap **Confirm**.
 - Modify: Tap the created time plan to make modifications.
 - Delete: Swipe left on the created time plan to delete it.
 - Create: Tap **Create time plan** to create a new one.

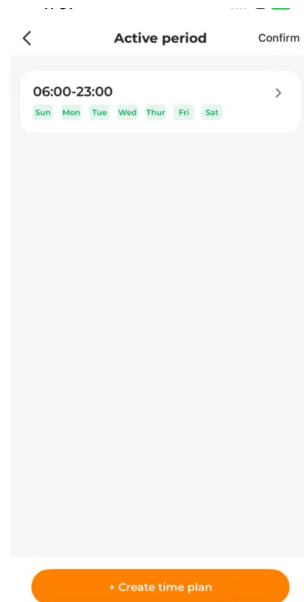

10. After the initial preset guide is completed, the user can tap **Active period** on the smart switch's device details page to modify, delete, and create multiple time plans.

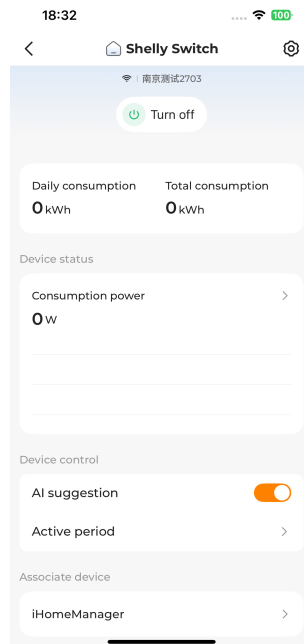

You cannot delete all time plans; at least one must be kept.

9.10.2.2 Add Shelly Relay

Preconditions

- Ensure that the connected smart switch is on the same router as the iHomeManager and is powered on.
- Ensure that the smart switch is within the WiFi range of the router, and that the network connection is stable.
- To connect multiple smart switches, it is recommended to add them one by one to avoid confusion. Up to 12 smart switches can be connected.



Currently, the only supported Shelly relay is Shelly 2PM Gen4.

Procedure

1. Log in to the App, and tap the target plant. Select the **Device** tab.

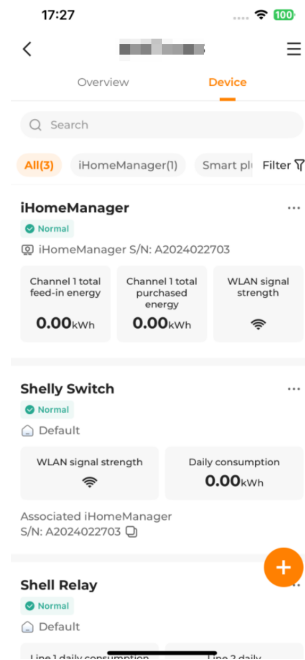

2. Tap . On the pop-up **Add device** page, tap the detected smart switch. Alternatively, you can manually add devices.

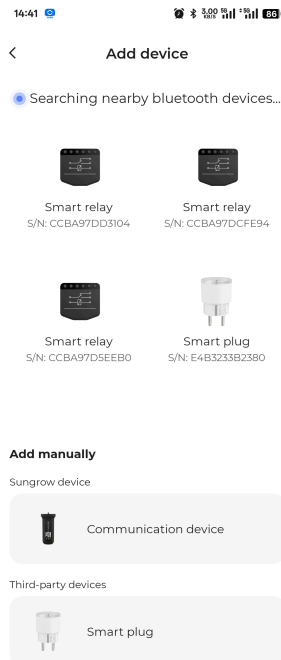

3. On the pop-up **Select home WiFi** page, choose a WiFi and enter the password. Tap **Next** to verify.

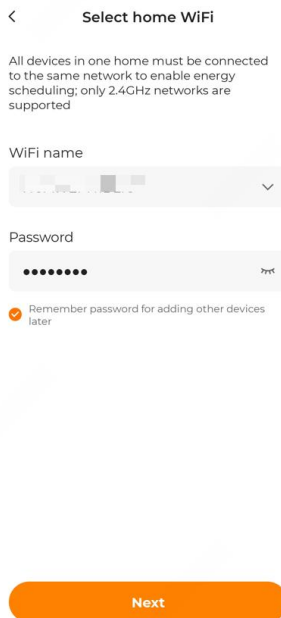

4. After successful adding, return to the **Device** tab to view the added device.

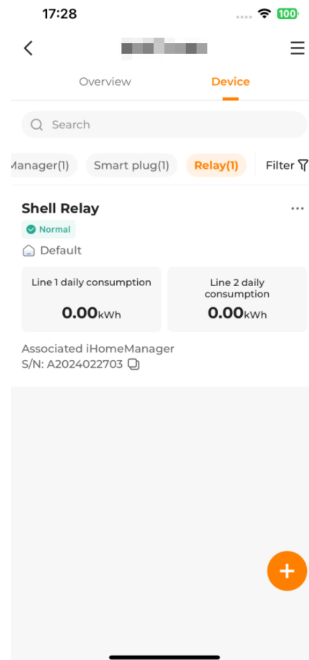

To facilitate future use and management, it is recommended to set the name of the smart switch as the name of the connected electrical appliance. Tap on the left side of the device to customize the device name.

5. Tap the added smart switch to view Daily consumption, Total consumption, and Consumption power of the household appliance connected to the smart switch. Tap to turn on or off the household appliance connected to the smart switch. Tap in the upper-right corner to view the device details or delete the device.



The relay supports switching between two independent switches to control the household appliance.

6. Tap **Consumption power** to view the daily consumption on the pop-up page, and enable or disable **Consumption**.

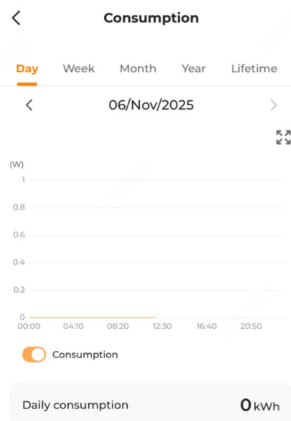

7. Tap **Device configuration file**. In the pop-up **Mode** dialog box, select a mode, then tap **Confirm**.

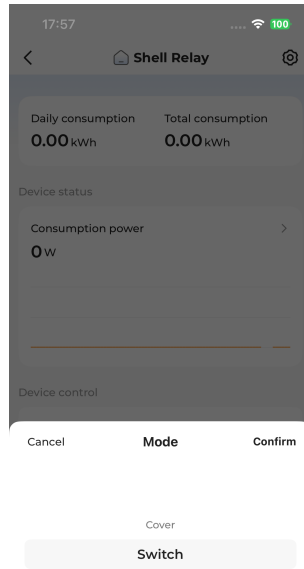

- Switch mode: In this mode, the relay controls two independent smart switch.
 - a. After a mode is selected, enable **AI suggestion** (disabled by default). On the pop-up **Preset guide** page, set **Nominal power** and **Single-use duration**, and select a Usage cycle preference. Options include Recommended and Custom. Tap **Next**.

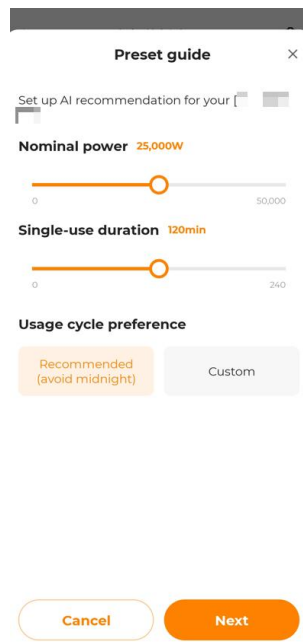

- b. On the pop-up **Create time plan** page, set the Start time, End time, and repeat days, then tap **Save**.

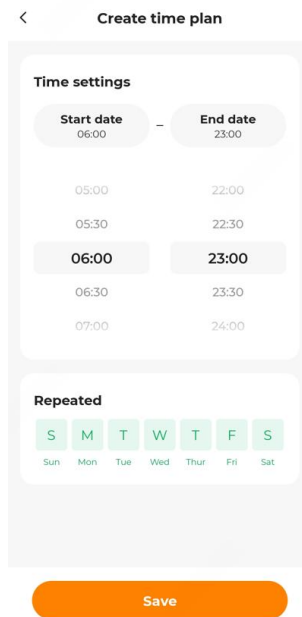

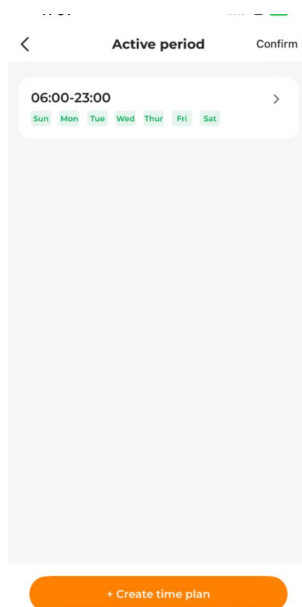

- c. On the pop-up **Active period** page, you can modify, delete, and create multiple time plans, then tap **Confirm**.
- Modify: Tap the created time plan to make modifications.
 - Delete: Swipe left on the created time plan to delete it.
 - Create: Tap **Create time plan** to create a new one.

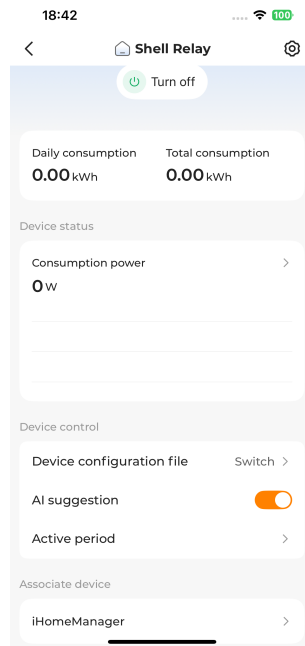

- d. After the initial preset guide is completed, the user can tap **Active period** on the smart switch's device details page to modify, delete, and create multiple time plans.



You cannot delete all time plans; at least one must be kept.

- **Cover mode:** The default option. In this mode, the relay controls the roller shutter door. Tap the , , or  buttons to control the roller shutter to rise, lower, or pause.

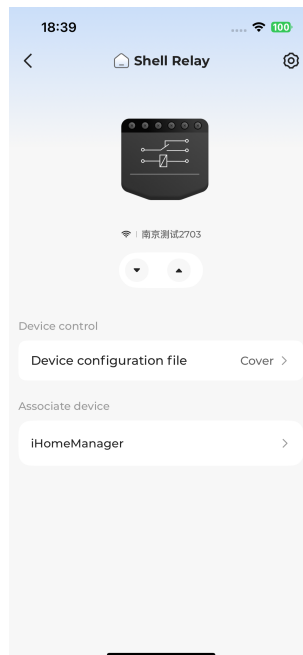

9.10.2.3 Add EEBUS Heat Pump

Preconditions

- Ensure that the connected device is on the same router as the iHomeManager and is powered on.
- Ensure that the device is within the WiFi range of the router, and that the network connection is stable.
- iHomeManager supports connecting DO or EEBUS heat pumps, but only one heat pump can be connected.

Procedure

1. Log in to the App, and tap the target plant. Select the **Device** tab.

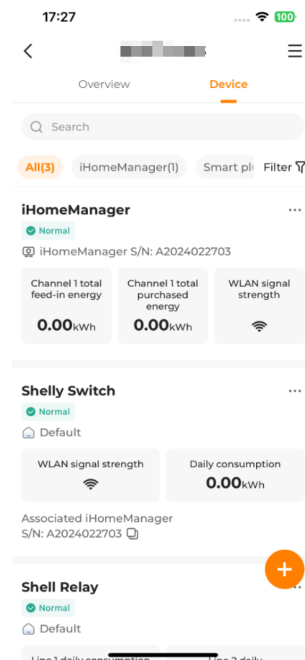

2. Tap . On the pop-up **Add device** page, add the heat pump manually.

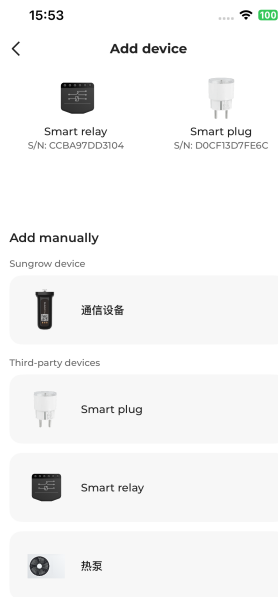

3. On the pop-up **Add heat pump** page, select the detected device.

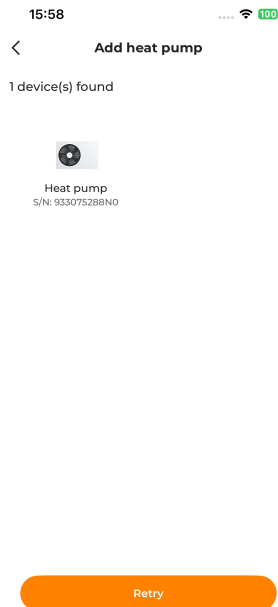

If the device is not detected, check the following before tapping **Retry** to continue searching. If the device is not detected, tap to continue searching.

- Ensure that iHomeManager is a trusted app in the added device.
- Ensure that the current plant is properly connected to the heat pump.

4. After successful adding, return to the **Device** tab to view the added device.

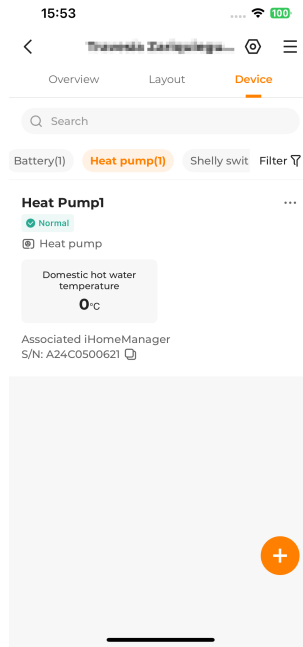

To facilitate future use and management, it is recommended to set the name of the smart switch as the name of the connected electrical appliance. Tap ... on the left side of the device to customize the device name.

5. Tap the added heat pump to view the Domestic hot water temperature and Consumption power on the device details page. Tap  in the upper-right corner to view the device details and delete the device.

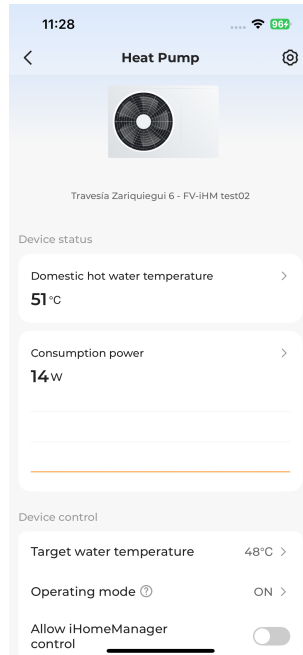

6. Tap **Domestic hot water temperature** to view the daily water temperature power consumption in the pop-up window, and enable or disable **Domestic hot water temperature** consumption.

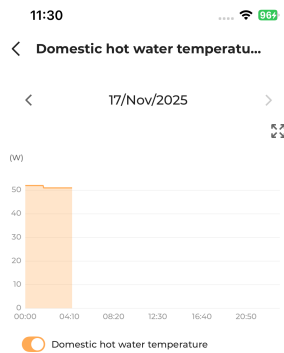

7. Tap **Consumption power** to view the daily consumption on the pop-up page, and enable or disable **Consumption**.

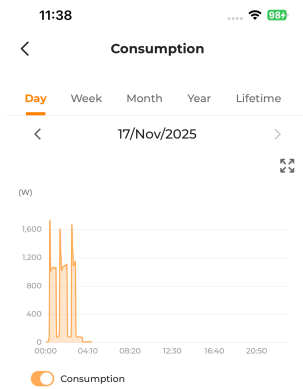

8. Tap **Target water temperature** to set the target temperature (range: 35°C–70°C) in the pop-up window, then tap **Confirm**.

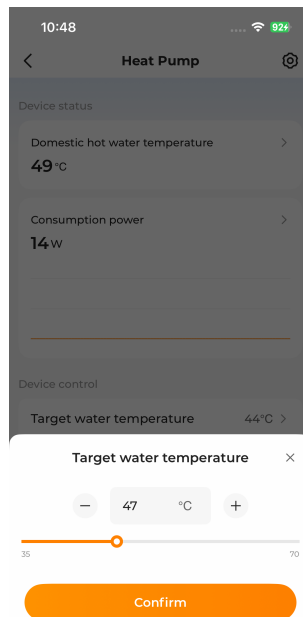

9. Tap **Operating mode** to select a mode in the pop-up window. Take a Vaillant heat pump as an example:
- **Off:** The default option. Force the heat pump off.
 - **On:** The system will ignore the time setting and automatically adjust the temperature within the set temperature range according to the target temperature.

- **Auto:** According to the set weekly time plan, it will only be enabled within the set time period and automatically adjust the heating to the target temperature. Force the heat pump off outside the time period.
- **Eco:** This mode is not supported.

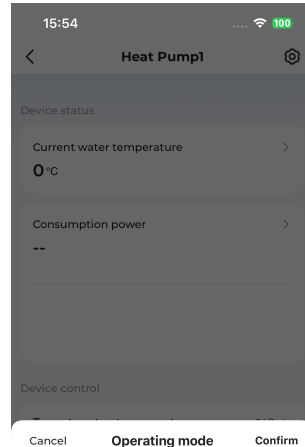

- The operating modes are based on the modes supported by the actual connected device.
- When **Allow iHomeManager control** is enabled, the heat pump will enter the **Auto** mode, and the Operating mode cannot be modified.

10. Set **Allow iHomeManager control**.

- **Enable:** Indicates allowing AI dispatch and enabling iHomeManager's Self-consumption mode to control the EEBUS heat pump.
- **Disable:** The default option, which indicates prohibiting AI dispatch and disabling iHomeManager's Self-consumption mode to control the EEBUS heat pump.

11. If **Allow iHomeManager control** is enabled, on the pop-up **Preset guide** page, set the **Nominal power** and **Single-use duration**, and select a Usage cycle preference. Options include Recommended and Custom. Then, tap Next. Tap **Next**.

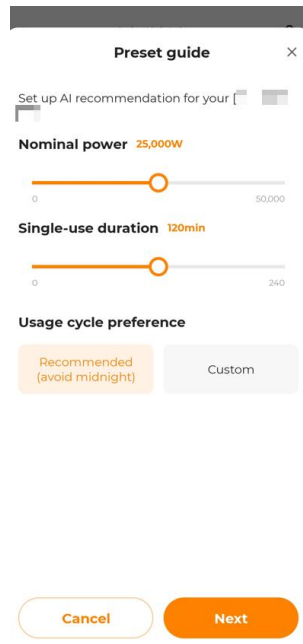

12. On the pop-up **Create time plan** page, set the Start time, End time, and repeat days, then tap **Save**.

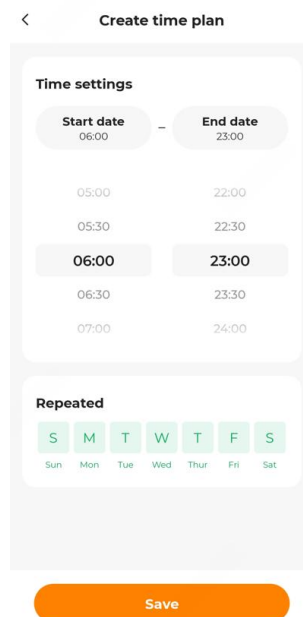

13. On the pop-up **Active period** page, you can modify, delete, and create multiple time plans, then tap **Confirm**.

- **Modify:** Tap the created time plan to make modifications.
- **Delete:** Swipe left on the created time plan to delete it.
- **Create:** Tap **Create time plan** to create a new one.

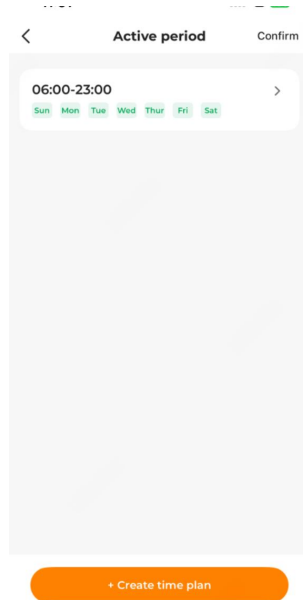

14. After the initial preset guide is completed, the user can tap **Active period** on the smart switch's device details page to modify, delete, and create multiple time plans.

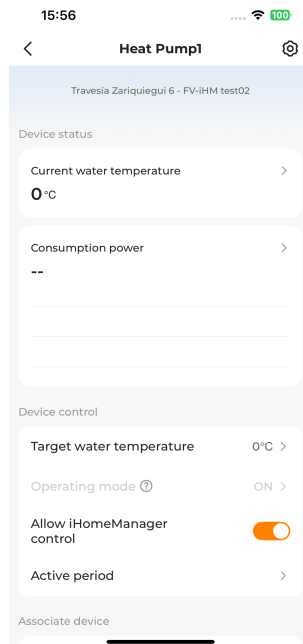



You cannot delete all time plans; at least one must be kept.

9.10.3 Delete Device

You can delete the devices that are no longer needed on site.

Steps

1. Tap  in the upper right corner of the **Device List** screen.
2. Tap  to go to “**Edit Device List**”.
3. Tap  following the device to be deleted.
4. Tap **Confirm** in the confirmation dialog.

9.11 Other Functions



The following functions are the capabilities of the iHomeManager device itself.

9.11.1 Firmware Update

Requirements

Log in to the App, and choose **Support > Firmware Download** to download the firmware update package. For details, see “9.2 Firmware Download” in the user manual for iSolarCloud App. You can scan the QR code below for the user manual.



Steps

1. Choose **More > Firmware Update**.
2. Tap on the update package. A confirmation dialog will then appear on the screen. Tap **Confirm** to start updating.
3. Wait for the update to finish. A message will show on the screen after the update is completed successfully. Then, tap **Complete**.

9.11.2 Download Logs

Users can download and share system logs.

1. Choose **More > Download Log**.
2. Select the types of logs and tap **Download**.
3. Wait for the download to complete. Then, tap **Confirm** to go to the list of downloaded files.

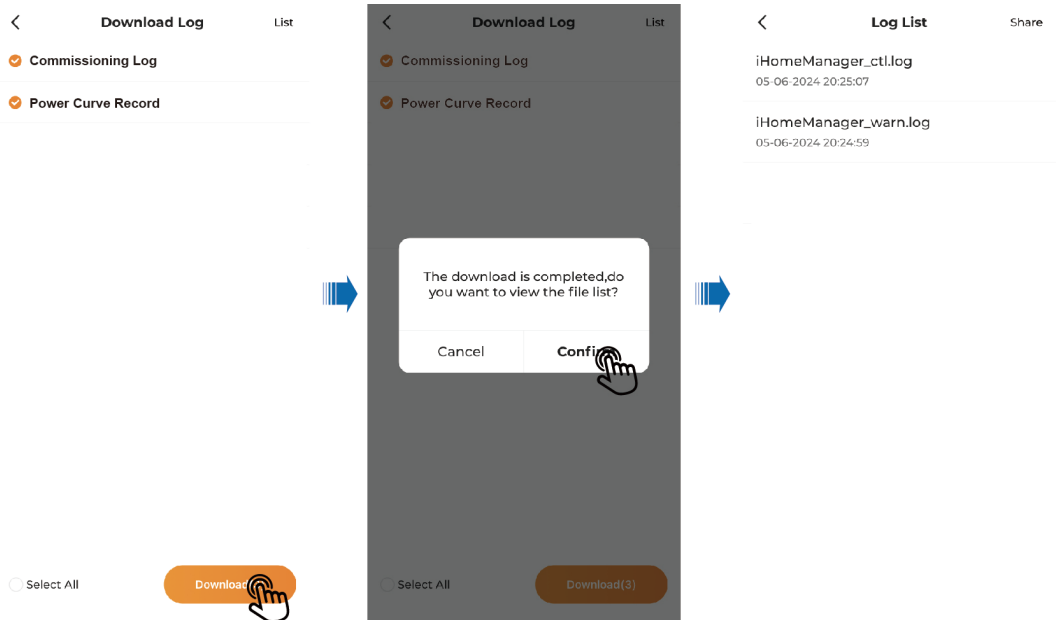



4. Tap **Share** in the upper right corner and select the types of logs to be shared.
5. Tap **Share** and choose how to share the logs.



Please switch to mobile data or connect your mobile device to a home network for log sharing.



9.11.3 Network Configuration

After logging in, go to the **Home** screen, and tap  in the upper right corner to go to “**Network Configuration**”.

- Check the network status
 - : The device is connected to the home network.
 - : The device is not connected to any home network.
- WLAN or Ethernet connection
For details, please refer to [9.4.1 Network Configuration](#).

9.11.4 Server Settings

After logging in, tap **Home** in the upper right corner of the  screen to select a server.

- Check the connection to cloud service
 - : Connected to cloud service.
 - : Not connected to any cloud service.
- Select a server

1. Tap .
2. Select a server based on the location of the device.
 - Mainland China: **Chinese Server**.
 - Europe: **European Server**.
 - Australia: **Australian Server**.
 - Other countries/regions: **International Server**.

9.11.5 Certificate Management

supports the import of HTTPS certificates and Modbus TCP certificates.



The function is supported in versions iHomeManager-SV930.001.00.P006 and above.

Pre-configured Certificate Risk Statement

Certificates are pre-configured on SUNGROW devices during the manufacturing process as their necessary identity credentials. Regarding the use of these pre-configured certificates, please note the following:

- Pre-configured certificates are only used to establish an initial secure channel for the device to access the customer network during the deployment process. SUNGROW does not promise or guarantee the security of the pre-configured certificates.
- SUNGROW does not promise or guarantee the security of the pre-configured certificates when used in services. It is recommended that users replace them with their own secure certificates.
- The validity period for the HTTPS and Modbus TCP certificates pre-configured by SUNGROW is 30 years. Once a pre-configured certificate expires, the related service will be interrupted.
- If users choose to use their own certificates, it is recommended that they properly manage the certificate lifecycle. Certificates with a short validity period are recommended to ensure security.

Steps

1. After logging into the device, go to the homepage, choose **More > Certificate Management** to import user certificates.

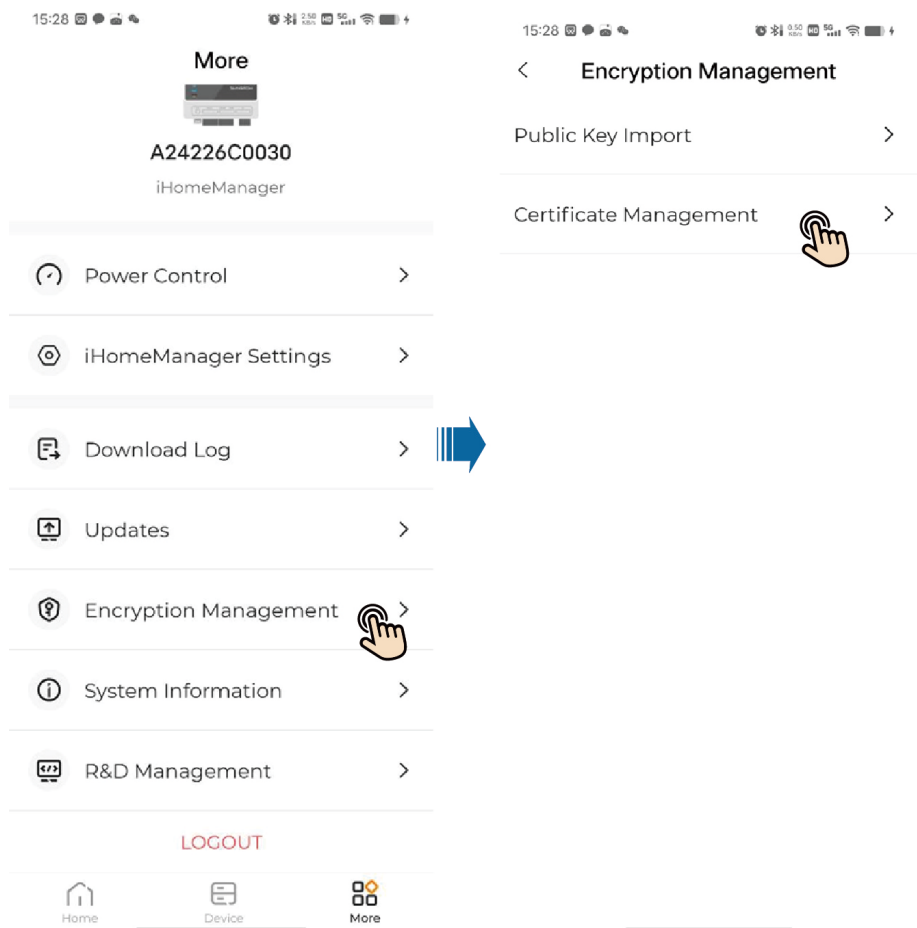

2. On the **Certificate Management** page, select the type of certificate to be imported.
 - **HTTPS Certificates:** On the **Certificate Management** page, select **HTTPS Certificate**, verify certificate details, and tap **Certificate Update**. Upload the certificate file and private key file on the **Import Certificate** page, then tap **Confirm**.

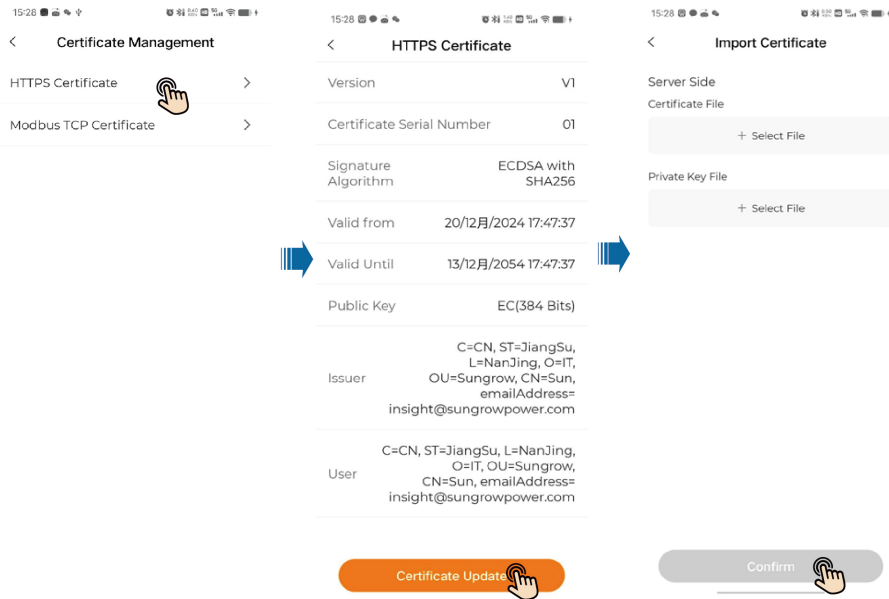

- Modbus TCP Certificates:** On the **Certificate Management** page, select **Modbus TCP Certificate**, select the **Server Side** or **Client** tab, verify certificate details, and tap **Certificate Update**. Upload the certificate file and private key file on the **Import Certificate** page, then tap **Confirm**. Take the Server Side as an example:

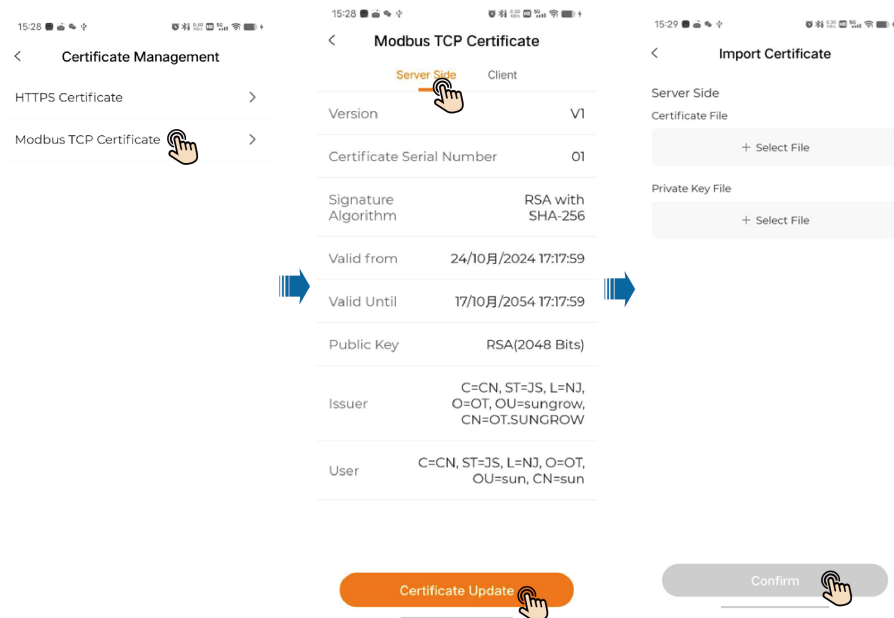

9.11.6 Communication Settings



- This function is available on iHomeManager-SV930.001.00.P014 or later.
- On the European server, the remote communication settings can be enabled/disabled after local login.

Procedure

1. After your login to the device, click **More > Communication settings > iSolarCloud**.

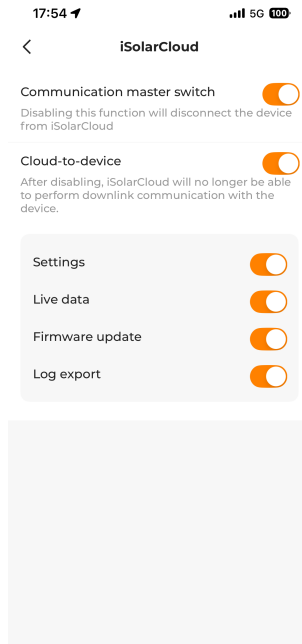

2. You can enable/disable **Communication master switch** (enabled by default). If it is disabled, the device will disconnect from iSolarCloud, monitoring and O&M services from iSolarCloud for the device are discontinued, and you cannot switch servers.
3. You can enable/disable **Cloud-to-device** (enabled by default). If it is disabled, iSolarCloud will no longer be able to perform downlink communication with the device.
4. The downlink communication setting manages sub-level switches, including parameter settings, live data, firmware update, and log export, all of which are enabled by default. If one of the switches is disabled, the device will no longer respond to the relevant commands from iSolarCloud.



Communication master switch, **Cloud-to-device**, and specific downlink communication functions form a three-tiered top-down control chain. Closing the switches at the previous level will automatically disable all switches at the next lower level, and the operation pages for those lower-level switches will no longer be displayed.

9.11.7 User Management

9.11.7.1 Change Account Password

The password can be reset in the following ways:

1. Press the RST key on the front of the device 5 times in a row to reset the password to the initial. For login steps, see [9.2.2 Local Access](#).
2. Log in to iSolarCloud to reset your password. For details, see [Reset password on iSolarCloud](#).
3. Press and hold the RST key for 30 seconds to factory reset the device. The password will be reset to the initial, and the history data will all be deleted.

⚠ CAUTION

Please proceed with factory reset with caution.

Reset password on iSolarCloud

1. Log in to the iSolarCloud App with the email address provided when creating a plant (see [9.4.5 Create Plant](#)).
2. Select the plant where the iHomeManager is located.
3. Choose the **Device** tab on the top and select the target iHomeManager.
4. Choose **Settings > System Parameters**.
5. Set **Reset Login Password** to **Enable**, and tap **Confirm**.

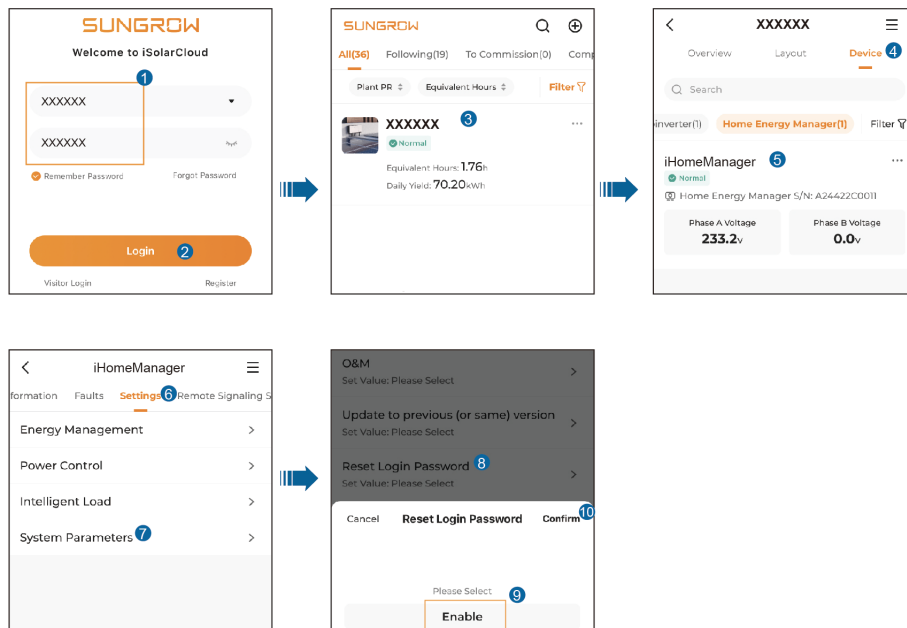

9.11.7.2 Logout

Steps

1. Choose **More**.

2. Go to the bottom of the list and choose **Logout > Confirm**.
3. You will then go back to the login screen of the iSolarCloud App. See [9.2.2 Local Access](#) for how to log in to the App.

10 Troubleshooting

DANGER

Device damage or system fault may lead to electric shocks or fire.

- Visually inspect the device for damage or other potential hazards before operation.
- Check that the external devices and electrical connections are in a safe state.

10.1 Fault List

Log in via local access to the iSolarCloud App, and go to **Home > Device**. Then, tap **Filter** in the upper right corner and select a fault status as the filter criteria. Devices with faults will then be shown on the screen.

Tap the fault status to go to the fault list and check the fault details.

10.2 Fault Description

Fault ID	Fault Name	Fault Cause	Suggestions
1	Device Communication Abnormal	The iHomeManager cannot communicate with the device connected to it because the communication link is abnormal.	<ol style="list-style-type: none">1. Go to "Device Self-Test" on the App for an automatic communication link check, and take action as per the onscreen instructions.2. If the fault occurs repeatedly after troubleshooting, contact SUNGROW Customer Service.



If there is a fault in the device connected to the iHomeManager, perform troubleshooting by referring to the fault list chapter in the device's user manual.

10.3 FAQs

⚠ DANGER

Before inspecting any terminal or wiring, first power off the device and verify that the terminals are all voltage-free. Failure to do so may result in electrical shocks.

Question 1: WiNet/Charger goes offline

Possible cause	Suggestions
The router is rebooting.	Wait for the router to finish rebooting. The device can then connect to the router again.
(Wireless connection) The WLAN communication quality is poor.	<ol style="list-style-type: none"> 1. Check that the WiNet/charger is successfully connected to the router. 2. Check the distance between the WiNet/charger and the router. Adjust the position of the router properly if needed.
(Wired connection) The Ethernet cable is loose or disconnected.	Check that the network cable between the WiNet/charger/iHomeManager and the router is securely connected.
Modbus local port 516 is disabled, or SSL encryption is not enabled for the port	Log in to the WiNet-S2 or the charger via local embedded Web access and enable Port 516 and SSL encryption.

Question 2: Inverter goes offline

Possible cause	Suggestions
The RS485 cable is loose or disconnected.	Check that the RS485 cable between the iHomeManager and the inverter is securely connected.

Question 3: iHomeManager cannot find the device

Possible cause	Suggestions
The connected device is offline.	Check the device connection. See Question 1: WiNet/Charger goes offline and Question 2: Inverter goes offline .
The device is connected to the router's WAN/LAN auto-adaptation port. The network connection	<ol style="list-style-type: none"> 1. Check that the router is connected to an external network. 2. If it is not connected to an external network, go to the router configuration page and set the WAN port number.

Possible cause	Suggestions
cannot be established immediately.	
The IP addresses of iHomeManager and WiNet/charger are not in the same network segment because the routers are cascaded.	<ol style="list-style-type: none"> 1. It is recommended to use one router for networking. 2. Restart the router to which the device is connected, and initiate a device search again. 3. Go to the configuration page of the router to which the device is connected and check the IP address assignment. If the IP addresses are not in the same network segment, re-configure the router.

Question 4: iHomeManager is disconnected from the cloud

Possible cause	Suggestions
The router is rebooting.	Wait for the router to finish rebooting.
The router is not connected to an external network.	<ol style="list-style-type: none"> 1. Check that the router is connected to an external network. 2. Check whether the home network service is suspended by the operator due to overdue balance.
(Wireless connection) The WLAN communication quality is poor.	<ol style="list-style-type: none"> 1. Check that the iHomeManager is successfully connected to the router. 2. Check the distance between the iHomeManager and the router. Adjust the position of the router properly if needed.

Question 5: iHomeManager hotspot disappears

Possible cause	Suggestions
The hotspot turns off automatically if no device is connected to it for over 1 hour.	Press the RST key three times in a row to turn on the hotspot. The mobile phone can then find and connect to the WLAN hotspot.
The phone is located too far from the iHomeManager.	Make sure the phone is within the coverage of the device's WLAN signal.



If, after this, the problem still cannot be resolved, please contact SUNGROW Customer Service.

11 Maintenance

Regular routine maintenance is the guarantee for the normal operation and long service life of the iHomeManager.

DANGER

Before maintenance, be sure to power off the device and ensure the terminals are all voltage-free. Otherwise, it may result in electric shocks!

11.1 Maintenance Notices

DANGER

Do not open the product in case of any peculiar smell, smoke, or anything abnormal with the product exterior during maintenance. Perform service or restart the product by following the troubleshooting suggestions only if there is no such abnormal symptom.

Risk of personal injury or device damage due to improper servicing!

Be sure to use specialized insulated tools when performing high-voltage operations.

CAUTION

To prevent irrelevant personnel from operating the product by mistake or other accidents, please set up highly visible warning signages around the product or fence off a warning zone.

NOTICE

Touching the PCB or other static-sensitive components may cause damage to the device or component.

- Do not touch the circuit board unless it is necessary.
- Observe the provisions for protection against electrostatic discharge and wear anti-static wrist straps.

11.2 Routine Maintenance

NOTICE

To minimize the risk of electric shocks, do not perform maintenance operations that are not specified in this manual. If necessary, contact SUNGROW for maintenance. Losses arising from failure to observe this instruction will not be covered by warranty.

- If the product needs to be replaced during the operation and maintenance, please contact SUNGROW.
- Use only the original parts and components sold or recommended by SUNGROW when replacing any part or component of the product.

To extend the product's service life, be sure to keep a record of maintenance logs.



- Product maintenance and inspection must only be performed by qualified electrical engineers, and the maintenance work must be recorded in maintenance reports or logs.
- If, due to long-term operation, signs of aging or other hidden dangers are found on the product or its components, contact SUNGROW in time.



If the device encounters an exception and cannot function properly, contact Sungrow O&M personnel to replace the system via the USB port for restoration.

Inspection Item	Inspection Method
Operating environment	<ul style="list-style-type: none"> • Check whether any equipment that produces strong electromagnetic interference is placed around the product. • Check whether there is any heat source around the product. • Check whether there are corrosive materials around product.
Hardware maintenance	<ul style="list-style-type: none"> • Check whether the supply voltage is normal. • Check whether wiring terminals are securely connected. • Check whether the ground connections are properly made.
System cleanliness	<ul style="list-style-type: none"> • Check whether the product enclosure and its components and parts are clean. • Check whether the product's heat dissipation paths are all clear without blockage. If the path is blocked by foreign objects, clean it in time.

Inspection Item	Inspection Method
Connection of terminals, copper bars, and cables	<ul style="list-style-type: none">• Check whether the screws on the terminals are loose. In case the terminal gets loose, tighten it properly using a screwdriver.• Check whether the copper bars or screws are oxidized and discolored.• Check the product's electrical connections and the arrangement of cables.
Software maintenance	<p>Inspection after the device is powered on:</p> <ul style="list-style-type: none">• Log in to the App and check the device communication.• Log in to the App and check the parameter settings.• Log in to the App and check the software version.

12 Appendix

12.1 Technical Data

Technical Data	iHomeManager
Basic data	
Number of devices supported	Max. 7 (inverters: ≤5, charger: 1, heat pump: 1)
Communication	
RS485	2, communication distance ≤1000m
Ethernet port	1, 10/100Mbps auto-adaptive, communication distance ≤100m
Digital input	5 (4 for dry contact, RC for emergency stop via short-circuit)
Digital output	2, dry contact output
External CT connection	2
Accuracy of built-in meter	Class 1 (error ≤ 1%)
WLAN communication	802.11 b/g/n/ax, 2.4GHz
Antenna	Supports built-in and external antennas
Power supply	
AC input	Three-phase three-wire: 415Vac (L-L) Three-phase four-wire: 415Vac (L-L), 230Vac (L-N)
Power consumption	≤9W
Ambient conditions	
Operating temperature	-30°C to 60°C
Operating humidity	0% to 95%, non-condensing
Max. operating altitude	4000m

Technical Data	iHomeManager
Ingress protection rating	IP20
Mechanical data	
Dimensions (width * height * depth)	108mm * 95mm * 65mm
Weight	<800g
Mounting Method	Guide rail mounting or wall mounting
Compliance	
Certification	CE

12.2 Quality Assurance

If product faults arise within the warranty period, SUNGROW will offer complimentary repairs or replace the product with a new equivalent model at no additional cost.

Evidence

To be eligible for warranty service during the warranty period, customers must provide the original product purchase invoice showing the date of purchase. Additionally, the product's trademark must be intact and clearly visible. SUNGROW reserves the right to decline warranty service if these conditions are not met.

Conditions

- Products deemed unqualified for use will be reclaimed and disposed of, or recycled by SUNGROW in accordance with environmental regulations.
- Customers are required to grant SUNGROW a reasonable timeframe to perform repairs on the faulty device.

Exclusion of Liability

SUNGROW may refuse warranty service under the following circumstances:

- The complete unit or components have exceeded the free warranty period.
- Any damage sustained during the transportation of the device.
- Device malfunctions or damage caused by the use of non-standard or non-company parts or software.
- Device malfunctions or damage resulting from improper installation, modification, or use.
- Damage caused by unforeseen natural events.
- Device malfunctions or damage due to operations conducted by service organizations or individuals not affiliated with SUNGROW.

- Issues arising from installation and use beyond the scope prescribed in relevant international standards.
- Damage caused by unforeseen natural events.

Should a product failure arise from the above conditions, and the customer requests repairs, the company's service organization may conduct an assessment and provide a paid repair service.

12.3 Contact Information

If you still cannot resolve the issue or have questions after consulting this manual, please contact SUNGROW. For more efficient service, please provide the following information:

- Model of the device
- Serial number of the device
- Manufacturer and model information for upstream and downstream equipment
- Fault code/name
- Brief description of the problem

Aftersales service contact: 400 119 7799

For detailed information, see <https://www.sungrowpower.com/headquarter.html>

SUNGROW

Sungrow Power Supply Co., Ltd.

www.sungrowpower.com