

Quick Installation Guide

Hybrid Inverter

MG5/6/8/10/12RL



Backup Wiring Diagram (For South Africa)

Loads Connected to the Grid:

①	②	③	④	⑤	⑥	⑦	⑧
MG5/6RL:	≥150A/100V DC breaker*	≤40A/230V/400V AC breaker		Depends on loads	Depends on household loads and inverter capacity	30mA RCD (Comply with local regulation)	
MG8/10/12RL:	≥250A/100V DC breaker*	≤63A/230V/400V AC breaker					

Note 1: * If the battery is integrated with a readily accessible internal DC breaker, no additional DC breaker is required.

Note 2: The recommended values in the table are for reference only. The actual values must comply with local standard and actual conditions.

Note 3: The rated current of breaker ② is suggested to be lower than that of breaker ⑤.

Note 4: If the rated current of on-site power cables are lower than those recommended above, the breakers specification should be considered to match the power cables in first priority.

Note 5: The AC port takes power from the grid and is set according to the grid and is set according to the grid circuit breaker.

Note 6: MG8/10/12RL requires no PE connection at its generator terminal.

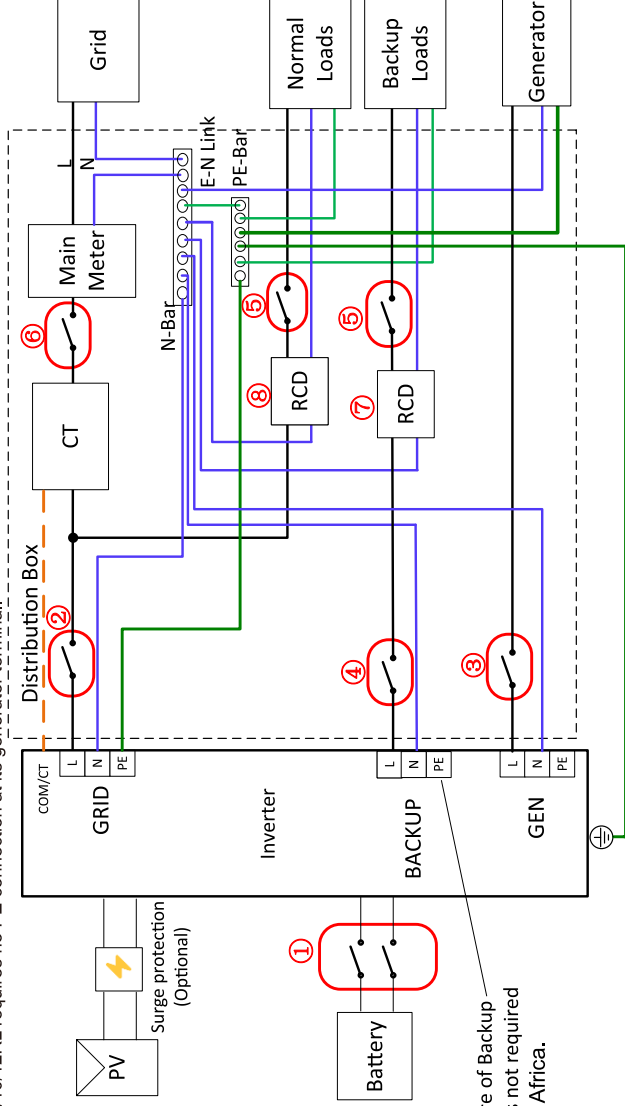

The PE wire of Backup terminal is not required for South Africa.

Backup Wiring Diagram (For other countries)

Loads Connected to the Grid:

①	②	③	④	⑤	⑥/⑦	⑧
MG5/8RL:	≥150A/100V DC breaker *	≤40A/230V/400V AC breaker	Depends on loads	Depends on household loads and inverter capacity (Optional)	30mA RCD (Recommended)	300mA RCD (Recommended)
MG8/10/12RL:	≥250A/100V DC breaker *	≤63A/230V/400V AC breaker	Depends on loads	Depends on household loads and inverter capacity (Optional)	30mA RCD (Recommended)	300mA RCD (Recommended)

Note 1: * If the battery is integrated with a readily accessible internal DC breaker, no additional DC breaker is required.

Note 2: The recommended values in the table are for reference only. The actual values must comply with local standard and actual conditions.

Note 3: The rated current of breaker ② is suggested to be lower than that of breaker ⑤.

Note 4: If the rated current of on-site power cables are lower than those recommended above, the breakers specification should be considered to match the power cables in first priority.

Note 5: The AC port takes power from the grid and is set according to the grid circuit breaker.

Note 6: MG8/10/12RL requires no PE connection at its generator terminal.

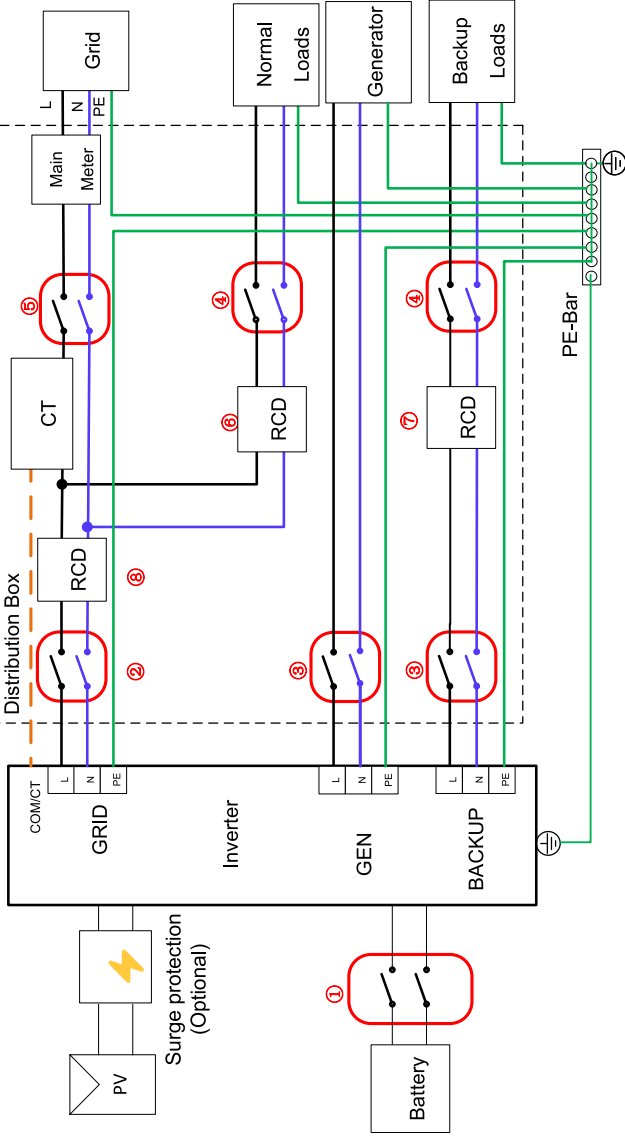

Backup Wiring Diagram (For TT system)

Loads Connected to the Grid :

①	②	③	④	⑤	⑥/⑦	⑧
MG5/6RL: $\geq 150\text{A}/100\text{V}$ DC breaker *	$\leq 40\text{A}/230\text{V}/400\text{V}$ AC breaker			Depends on household loads	30mA RCD	300mA RCD
MG8/10/12RL: $\geq 250\text{A}/100\text{V}$ DC breaker *	$\leq 63\text{A}/230\text{V}/400\text{V}$ AC breaker		Depends on loads and inverter capacity (Optional)		(Recommended)	(Recommended)

Note 1: * If the battery is integrated with a readily accessible internal DC breaker, no additional DC breaker is required.

Note 2: The recommended values in the table are for reference only. The actual values must comply with local standard and actual conditions.

Note 3: The rated current of breaker ② is suggested to be lower than that of breaker ⑤.







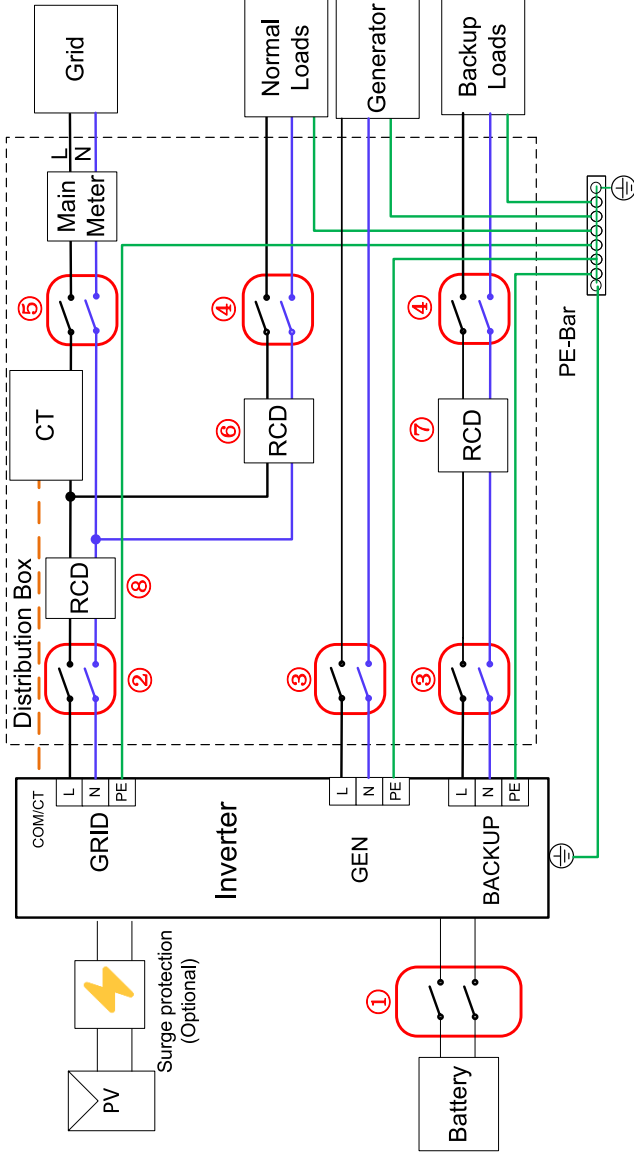



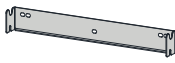

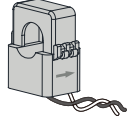

Note 4: If the rated current of on-site power cables are lower than those recommended above, the breakers specification should be considered to match the power cables in first priority.

Note 5: The AC port takes power from the grid and is set according to the grid circuit breaker.

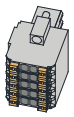
Note 6: MG8/10/12RL requires no PE connection at its generator terminal.

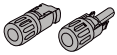
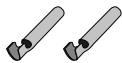



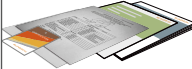





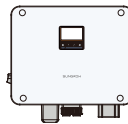
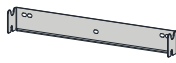

Scope of delivery (MG5/6RL)

 Inverter	 Wall-mounting bracket	 Battery connector	 AC connector (x3)
 Expansion plug set (x 3)	 M5×12 screw set (x 2)	 M4×16 screw set(x 4)	 Current transformer (CT)
 DO plug-in connector	 Signal plug-in connector	 Wire ferrule (×9)	 Wire ferrule (DIN end) (×12)
 PV connector (×2 set)	 Crimp contact (×2 set)	 Removal tool	 Desiccant
 WiNet-S2	 Documents		

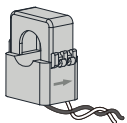
* The images shown here are for reference. The actual product and quantity are based on delivery.

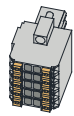
Scope of delivery (MG8/10/12RL)

 Inverter	 Wall-mounting bracket	 Battery connector	 AC connector
 Expansion plug set (x 3)	 M5×12 screw set (x 2)	 M4×16 screw set(x 2)	 Current transformer (CT)
 DO plug-in connector	 Signal plug-in connector	 OT Terminal (x 9)	 Wire ferrule (DIN end) (×12)

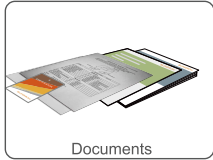
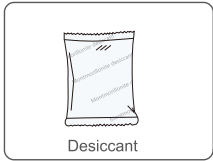
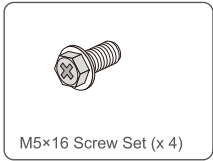
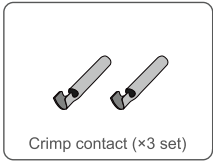
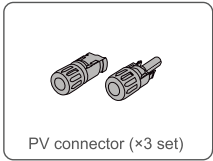

* The images shown here are for reference. The actual product and quantity are based on delivery.

Mounting Location

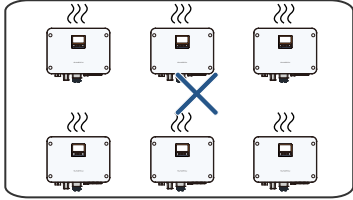
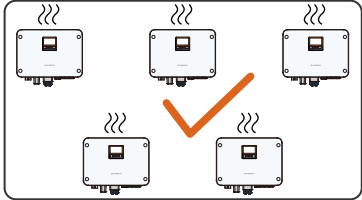
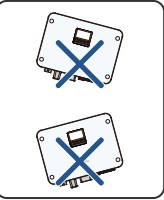
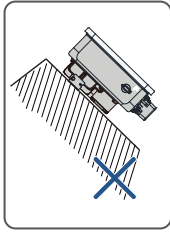
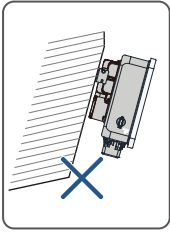
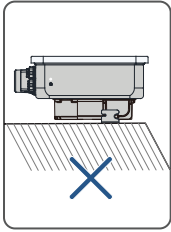
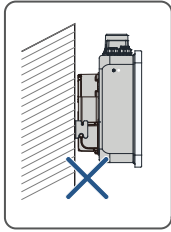
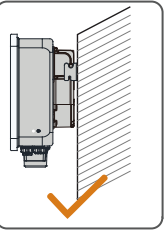
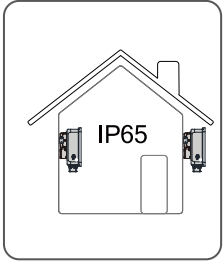
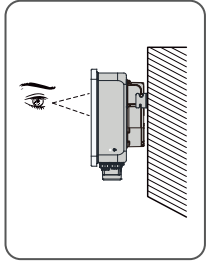
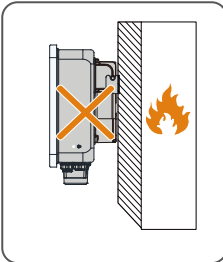
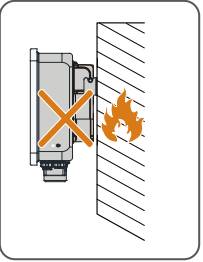
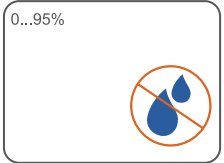
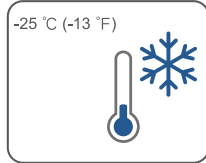
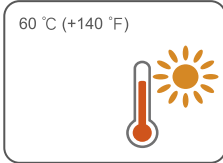

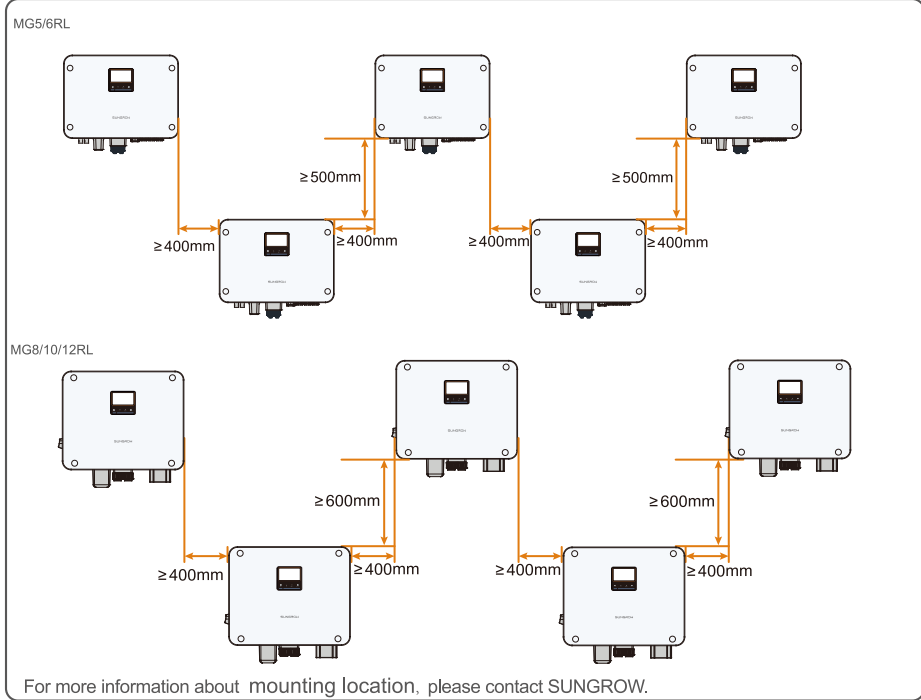
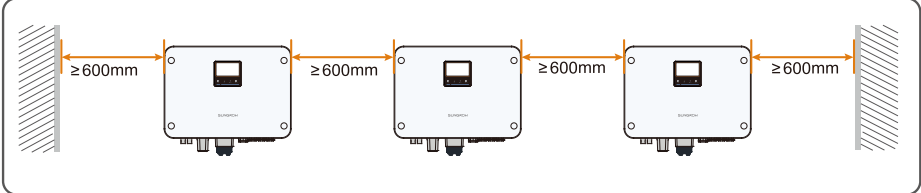
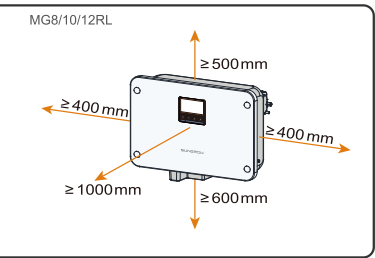
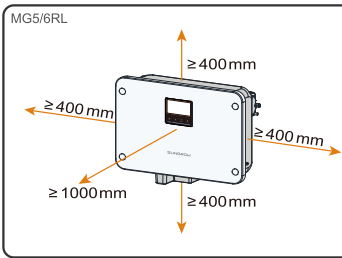
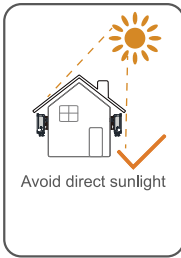

Installation Tools

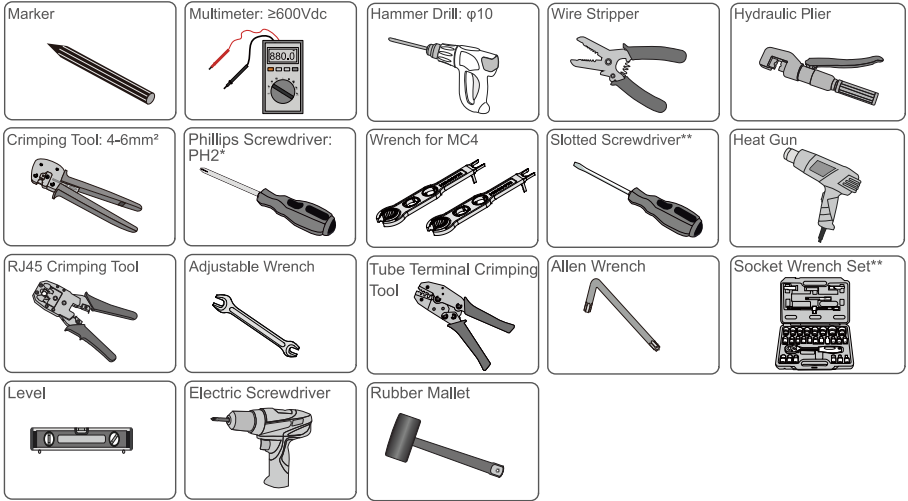

*A magnetic screwdriver with a shaft length of at least 200 mm is recommended.

**Magnetic tools are recommended.

Mounting

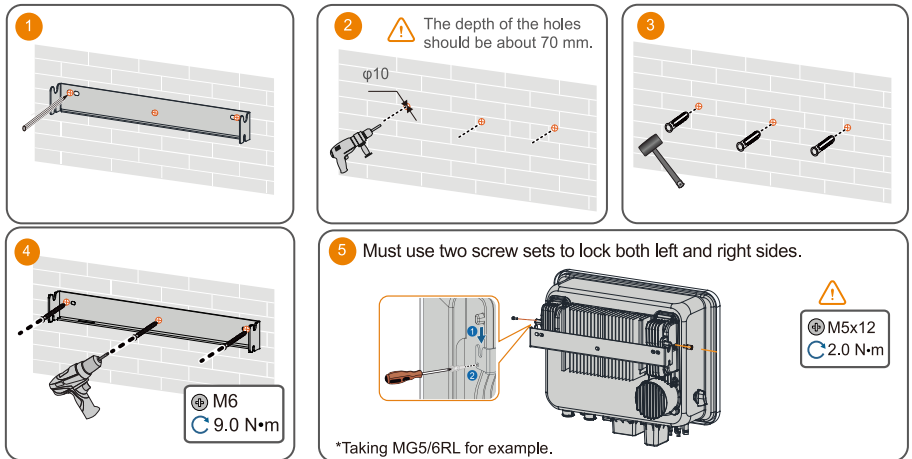

Terminal Description

MG5/6RL

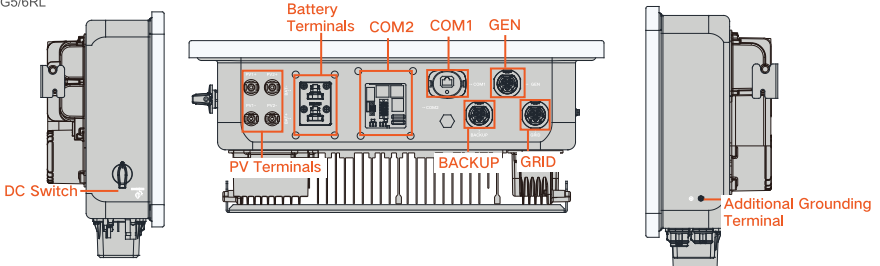

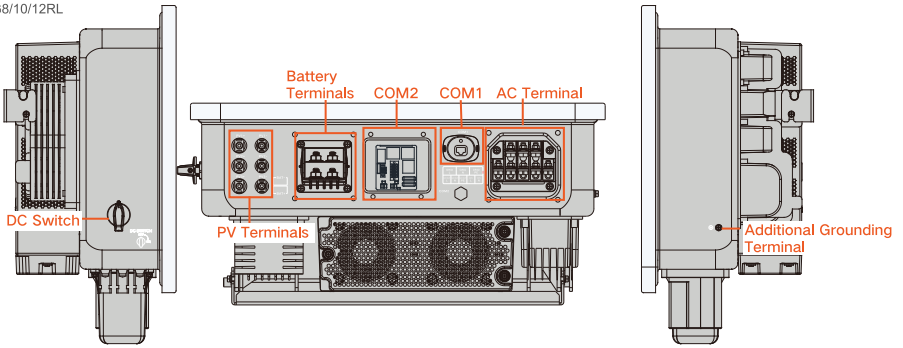

PE Connection

1

$L = E + (2-3)mm$

*OT/DT terminals need to be prepared by the user.

2

1: Heat shrink tubing 2: OT terminal

3

4

5

M5x12
2.5N·m

AC Cable Connection (MG5/6RL)

GRID

1

2

$\phi 13...17mm$
8AWG

A: 25...30mm
B: (E+2)mm

3

For single-strand wire
(Not recommended)

For multi-strand wire

4

3.0-4.0N·m

5

Click

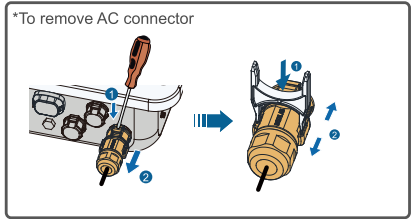
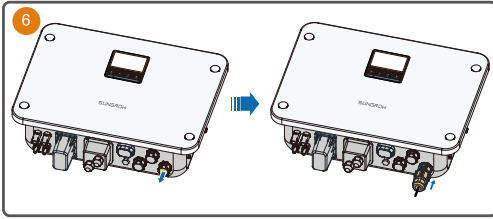

BACKUP

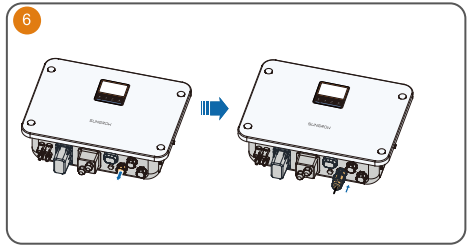
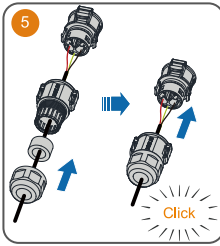
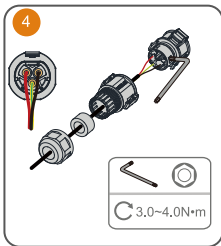
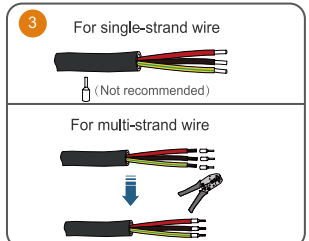
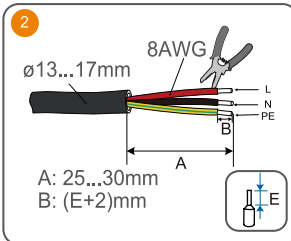
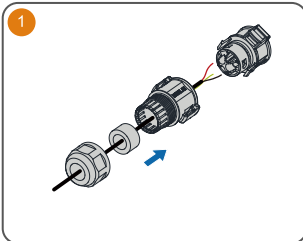

GEN

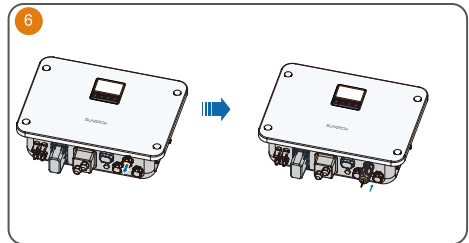
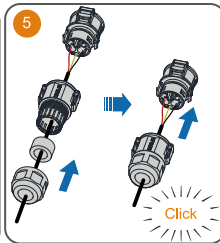
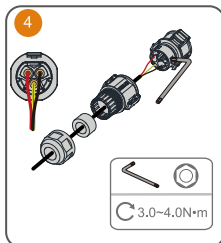
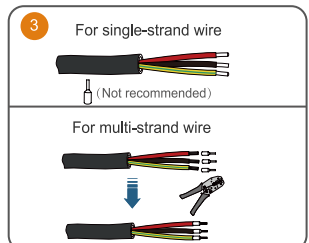
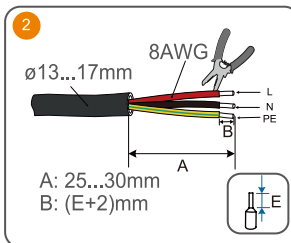
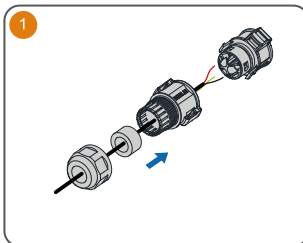

AC Cable Connection (MG8/10/12RL)

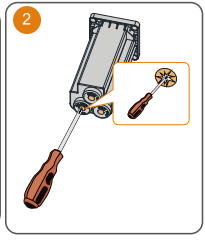
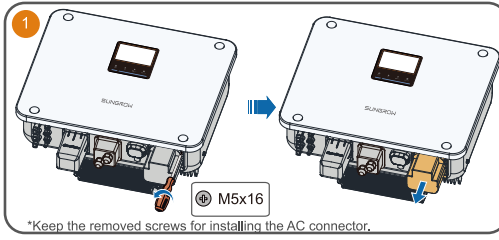
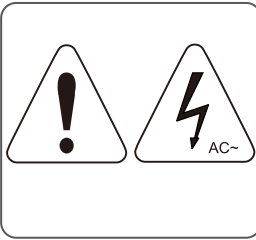

BACKUP

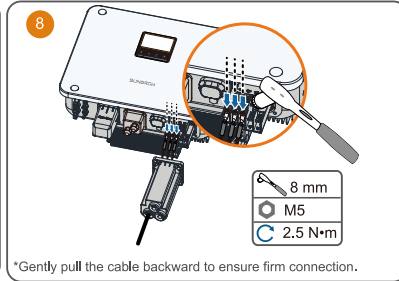
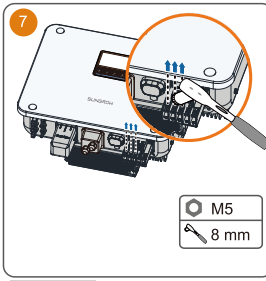
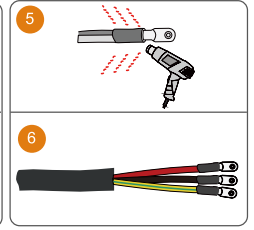
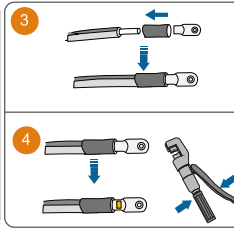
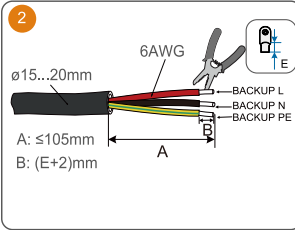
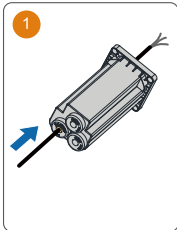

GEN

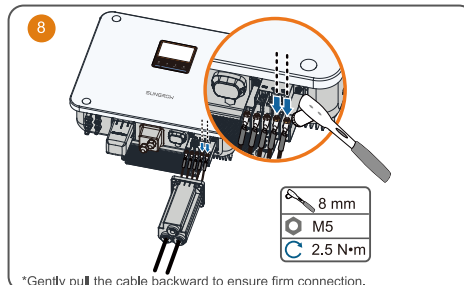
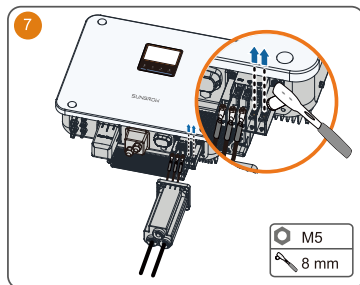
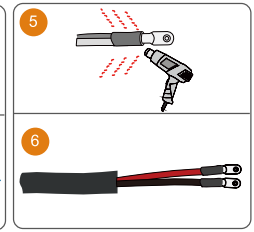
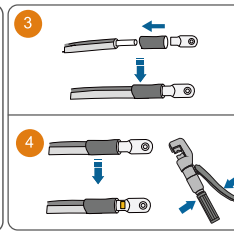
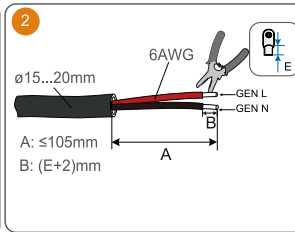
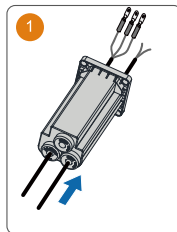

GRID

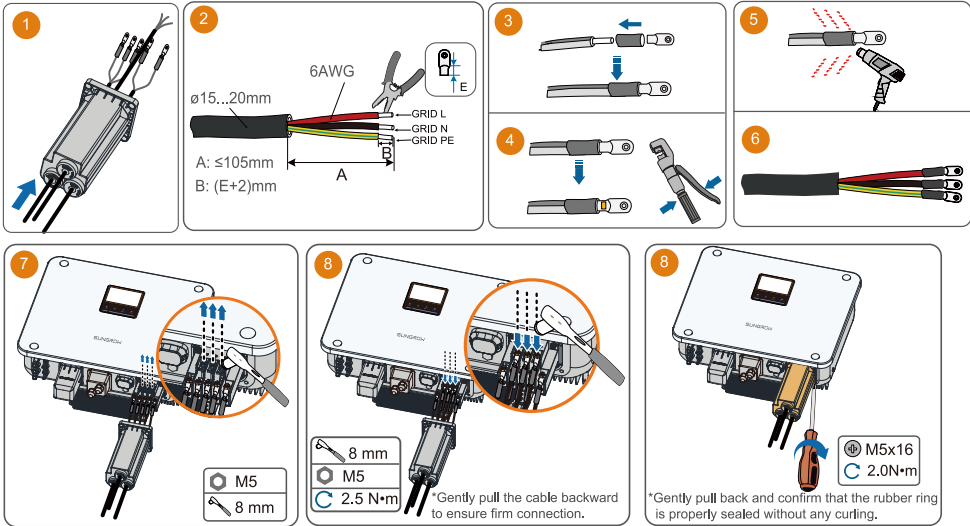

DC Cable Connection

*Taking MG5/6RL for example.

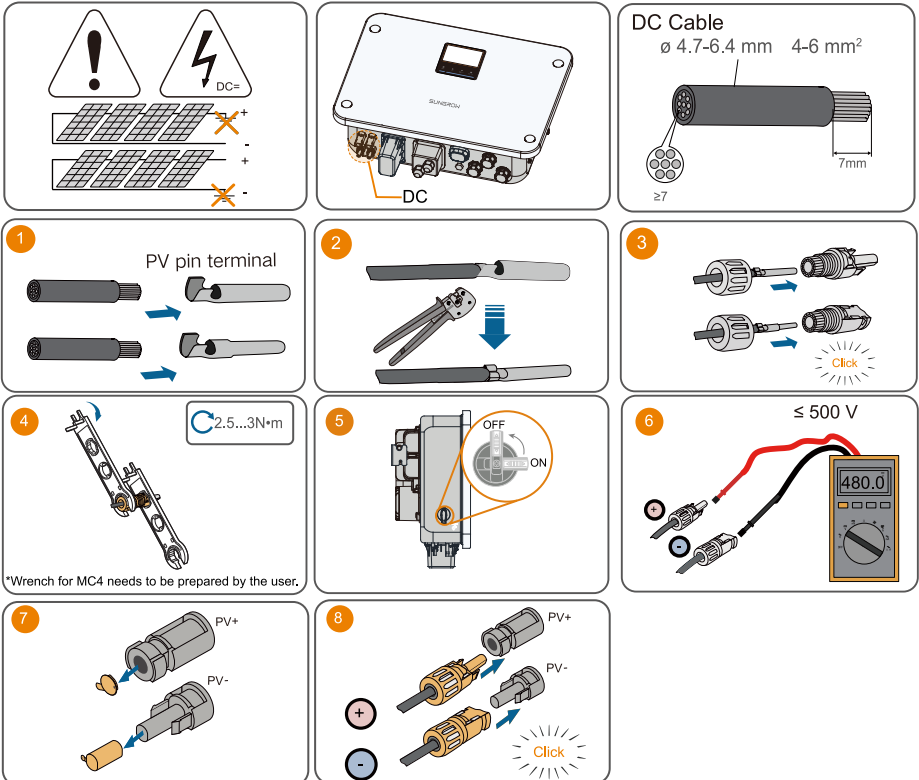

*Wrench for MC4 needs to be prepared by the user.

Battery Connection (MG5/6RL)

Battery DC Breaker
 Recommended DC Breaker
 V > Maximum battery voltage
 Recommended: 150 A

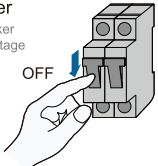

*If the battery does not have a readily accessible internal DC breaker, an additional DC breaker is required.

Battery Cable
 MG5RL: 35 mm²
 MG6RL: 50 mm²

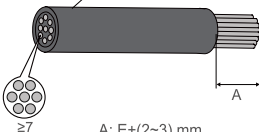

A: E+(2~3) mm



1

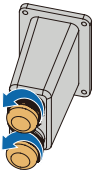

2

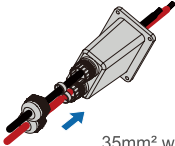

(x 2)
 35mm² wire: 9-13 mm
 50mm² wire: 12-16 mm

3

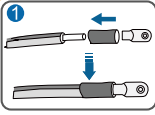
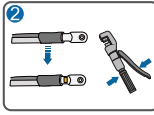
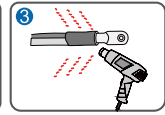



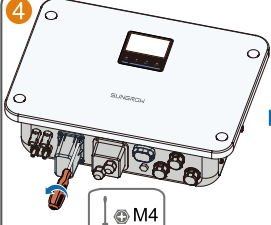
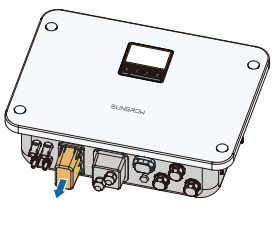

4



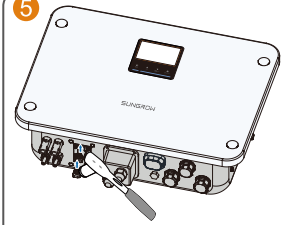

M4

5

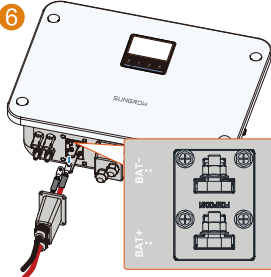
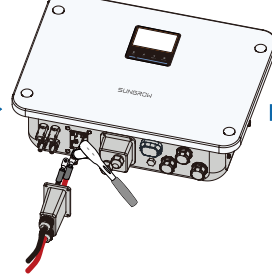
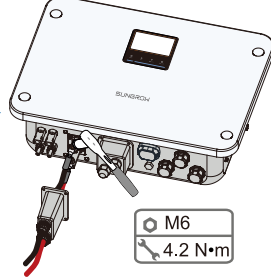

6





BAT+
 BAT-
 M6
 4.2 N·m

*Gently pull the cable backward to ensure firm connection.

⚠ Do not reverse the positive and negative terminals of the battery, otherwise the inverter may be damaged.

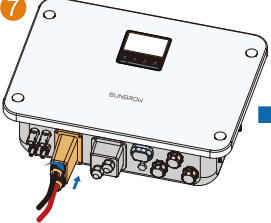
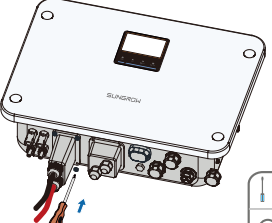
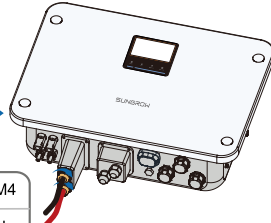
7





M4
 1.5N·m

Battery Connection (MG8/10/12RL)

Battery DC Breaker

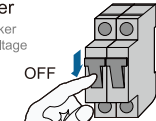
Recommended DC Breaker
 V > Maximum battery voltage
 I Recommended: 250A



*If the battery does not have a readily accessible internal DC breaker, an additional DC breaker is required.

Battery Cable

Battery ≤ 135 A: 35-50mm²
 Battery > 135 A: 70-95mm²/ 2 × 35-50mm²

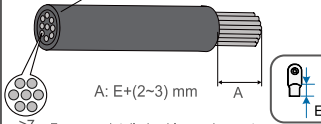

For more detailed cable requirements, please refer to the user manual.

1

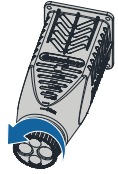

2

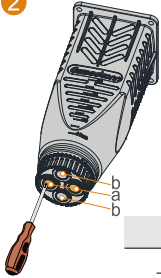

	Cable Diameter	Remove the rubber ring
	11-14mm	/
a	14-16mm	
	16-19mm	
b	11-14mm	/
	14-16mm	

3

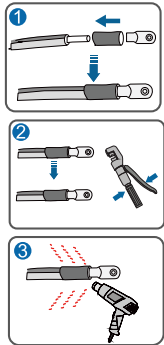
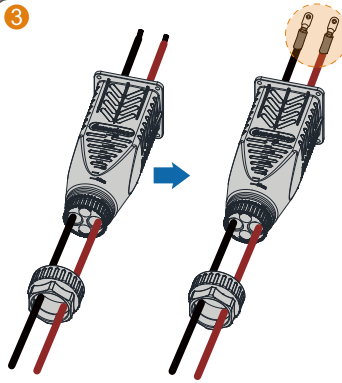

4

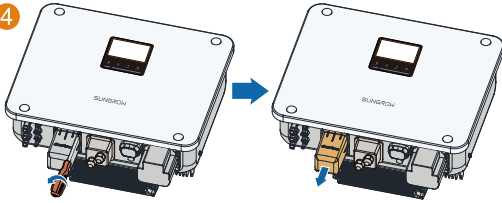

*Keep the removed screws for installing the battery connector.

M5

5

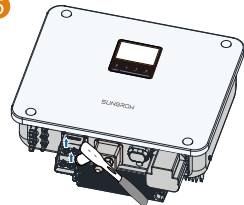

13 mm
 M8

⚠ Do not reverse the positive and negative terminals of the battery, otherwise the inverter may be damaged.

6

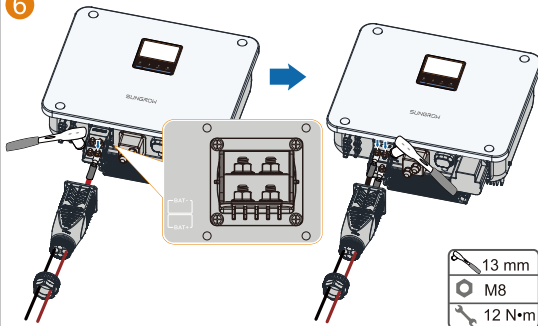

13 mm
 M8
 12 N•m

*Gently pull the cable backward to ensure firm connection.

7

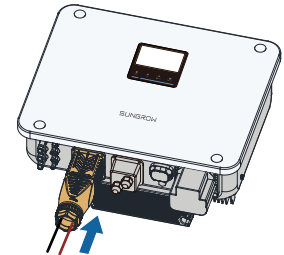

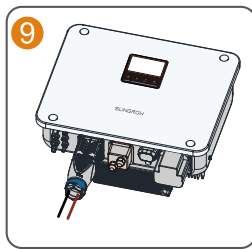
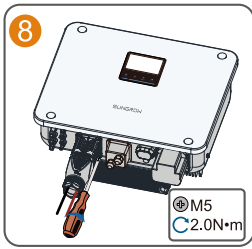

WiNet-S2 Connection

*Taking MG5/6RL for example.

• WLAN communication

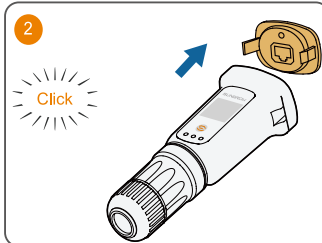
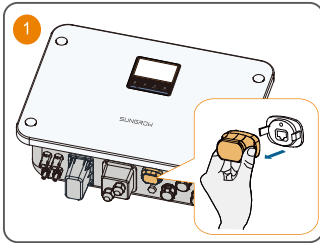

• Ethernet Communication

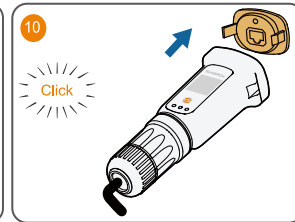
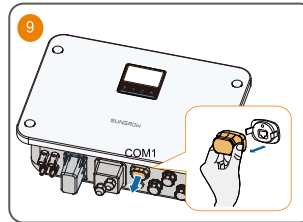
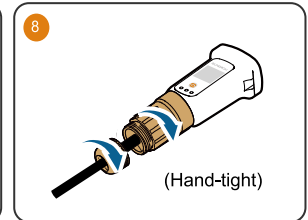
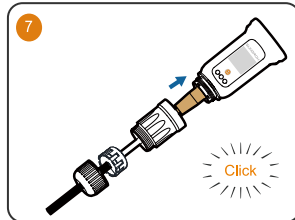
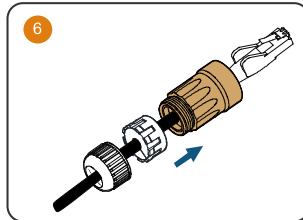
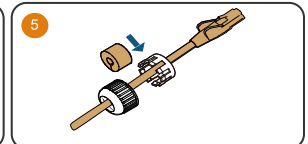
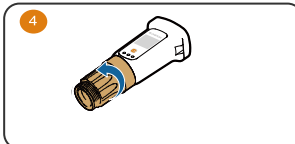
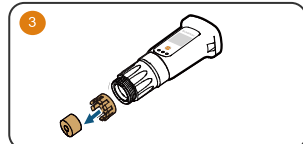
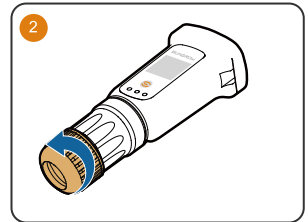
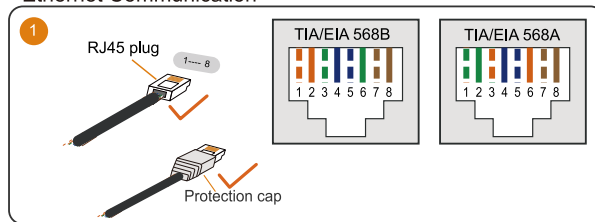

COM2 Terminal Communication Connection

*Taking MG5/6RL for example.

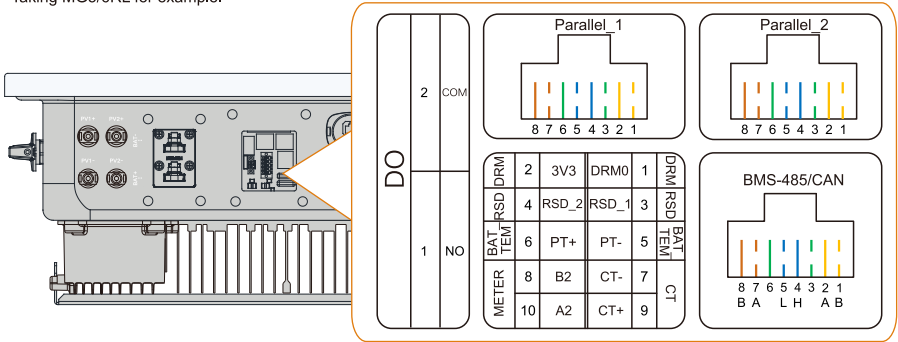

Label	Description
DO(NO/1, COM/2)	For ground fault alarm, intelligent load control or generator control.
Parallel_1	For master-slave parallel communication.
Parallel_2	For master-slave parallel communication.
DRM(3V3, DRM0)	Reserved (Detail availability contact SUNGROW).
RSD(RSD_1, RSD_2)	Reserved (Detail availability contact SUNGROW).
BAT_TEM(PT-, PT+)	For temperature sensor used for connecting to the lead-acid battery when the system is configured with lead-acid batteries.
METER(A2,B2)	For smart energy meter.
CT	For grid CT signal sampling.
BMS-485/CAN	Only 4/H and 5/L are used for li-ion battery communication via CAN protocol. RS485 protocol is reserved (Detail availability contact SUNGROW).

CT Connection

* The length of CT cable is 5m.

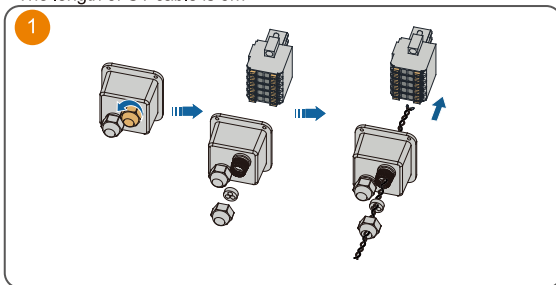

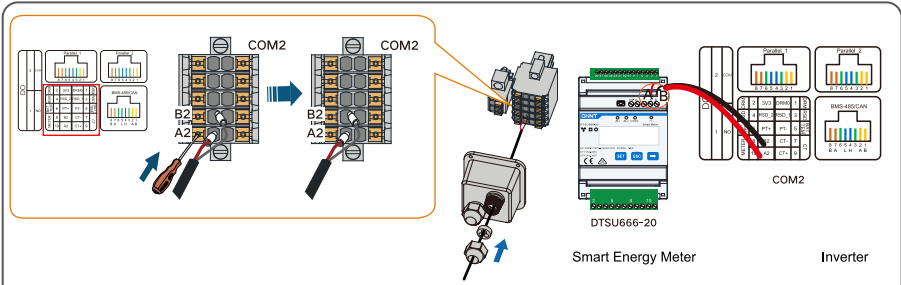

If the communication distance (L) $\leq 10m$, use a RS485 communication cable for connection directly. If $L > 10m$, add an extra 120Ω resistor to improve the communication quality.

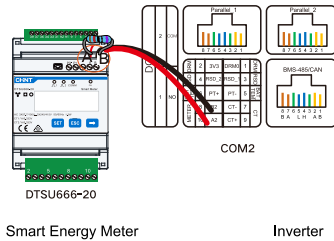

DO Connection (For GEN Communication)

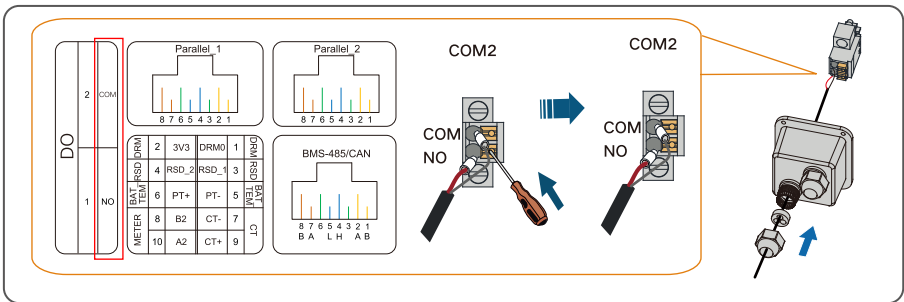

Li-ion Battery Communication

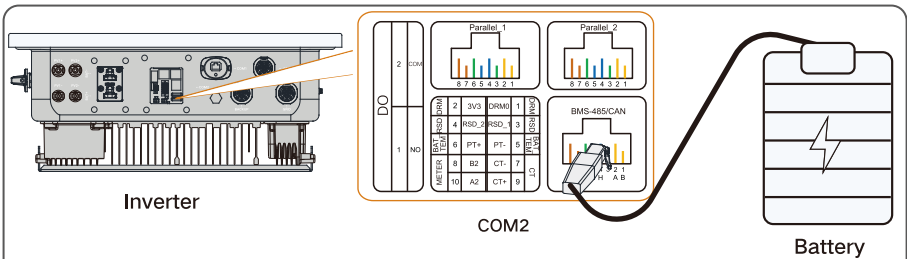

*Before connecting the communication cable, ensure the wire sequence is consistent.

Temperature Sensor Connection

1

2

3

WIRE COLOR	2	3V3	DR6A0	1
RED	RED_2	RED_1		RED_3
ORANGE	PT+	PT-		PT
BROWN	BS	CT-		CT+
BLACK	A2	CT+		CS

4

It is recommended to place the temperature sensor on the side of the battery located in the center of the battery cluster. This ensures that the system monitors the worst-case temperature conditions, preventing thermal runaway during charging or battery damage caused by local overheating.

5

M4
1.5Nm

Power on

1 DC

2 AC

3 Battery
Switch on Battery

4 LCD&LED Indicator

5 iSolarCloud App

- Wait 5 minutes after completing the previous step before proceeding to the next one.

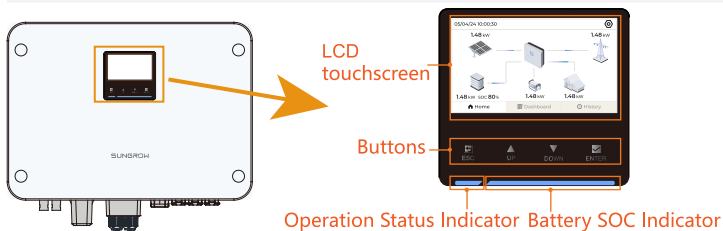

LED Indicator

LED indicator	LED state	Definition
	ON	The inverter is running in the on/off-grid mode.
	Twinkling	The inverter is at standby or startup state (without on/off-grid operation). The inverter is recovering from a fault.
	ON	A system fault has occurred.
	OFF	Both the AC and DC sides are powered down.

Battery SOC Indicator

Battery SOC Indicator	SOC
	0<SOC≤20%
	20%<SOC≤40%
	40%<SOC≤60%
	60%<SOC≤80%
	SOC > 80%

The dynamic flow direction of the LED light bar indicates the battery's charging/discharging status.

- SOC 0% → SOC 100%: Charging
- SOC 0% ← SOC 100%: Discharging

1. Contents may be periodically updated or revised due to product development. The information in this guide is subject to change without notice. In no case shall this guide substitute for the user manual or related notes on the device.
2. Make sure to read over, fully understand and strictly follow the detailed instructions of the user manual and other related regulations before installing the equipment. The user manual can be downloaded by visiting the website at <http://support.sungrowpower.com/>; or it can be obtained by scanning the QR code on the side of the equipment or the back cover of this guide.
3. All operations can be performed only by qualified personnel, that must be trained for installation and commissioning of electrical system, as well as dealing with hazards, have knowledge of the manual and of the local regulations and directives.
4. Before installation, check that the package contents are intact and complete compared to the packing list. Contact SUNGROW or the distributor in case of any damaged or missing components.
5. The cable used must be intact and well insulated. Operation personnel must wear proper personal protective equipment (PPE) all the time.
6. Any violation could result in personal death or injury or device damage, and will void the warranty.

Safety

The inverter has been designed and tested strictly according to international safety regulations. Read all safety instructions carefully prior to any work and observe them at all times when working on or with the inverter. Incorrect operation or work may cause:

- injury or death to the operator or a third party;
- damage to the inverter or other properties.

Please follow the safety instructions related to the PV strings and the utility grid.

DANGER

Lethal voltage!

- PV strings will produce electrical power when exposed to sunlight and can cause a lethal voltage and an electric shock.
- Only qualified personnel can perform the wiring of the PV panels.

NOTICE

Danger to life from electric shock due to lethal voltage!

- All electrical connections must be in accordance with local and national standards.
- Only with the permission of the local utility grid company, the inverter can be connected to the utility grid.

Inverter

The warning label on the inverter body are as follows.



Disconnect the inverter from all the external power sources before maintenance!



Do not touch live parts for 10 minutes after disconnection from the power sources.



Burn danger due to hot surface that may exceed 60 °C.



Danger to life due to high voltages!
Only qualified personnel can open and maintain the inverter.



Read the user manual before maintenance!



The inverter does not have a transformer.



Do not dispose of the inverter together with household waste.



TÜVRheinland mark of conformity.



CE mark of conformity.
EU/EEA Importer.



RCM mark of conformity.



Additional grounding point.

Users may also attach other warning signs as per the requirements of the local standards or installation specifications.

DANGER

Danger to life from electric shocks due to live voltage

- Do not open the enclosure at any time. Unauthorized opening will void warranty and warranty claims and in most cases terminate the operating license.
- When the enclosure lid is removed, live components can be touched which can result in death or serious injury due to electric shock.

Lethal danger from electric shock due to possibly damaged inverter

- Only operate the inverter when it is technically faultless and in a safe state.
- Operating a damaged inverter can lead to hazardous situations that can result in death or serious injuries due to electric shock.

WARNING

Risk of inverter damage or personal injury

- Do not pull out the PV connectors and AC connector when the inverter is running. Disconnect the AC circuit breaker, the circuit breaker of battery and set the DC load-break switch of the inverter to OFF. Wait 10 minutes for the internal capacitors to discharge. Verify that there is no voltage or current before pulling any connector.

WARNING

All the warning labels and nameplate on the inverter body:

- must be clearly visible.
- must not be removed, covered or pasted.

CAUTION

Risk of burns due to hot components!

- Do not touch any hot parts (such as the heat sink) during operation. Only the DC switch can safely be touched at any time.

NOTICE

Only qualified personnel can perform the country setting. Unauthorized alteration may cause:

- A breach of the type-certificate marking.

Risk of inverter damage due to electrostatic discharge (ESD)!

By touching the electronic components, you may damage the inverter. For inverter handling, be sure to:

- avoid any unnecessary touching.
- wear a grounding wristband before touching any connectors.

Battery

DANGER

Batteries deliver electrical power, resulting in burns or a fire hazard when they are short circuited, or wrongly installed.

Lethal voltages are present in the battery terminals and cables in the inverter. Severe injuries or death may occur if the cables and terminals in the inverter are touched.

NOTICE

Improper settings or maintenance can permanently damage the battery.

Incorrect inverter parameters will lead to the premature aging of battery.

EU Declaration of Conformity



within the scope of the EU directives

The object of the declaration described above is in conformity with the relevant Union harmonisation legislation:

Low Voltage Directive 2014/35/EU (LVD)

Electromagnetic compatibility 2014/30/EU (EMC)

Restriction of the use of certain hazardous substances 2011/65/EU and 2015/863/EU (RoHS)

The manufacturer Sungrow Power Supply Co. Ltd, China hereby confirms that the product MG5RL, MG6RL, MG8RL, MG10RL, MG12RL complies with the essential requirements and other relevant provisions of Directive 2014/35/EU (LVD), 2014/30/EU (EMC), 2011/65/EU and 2015/863/EU (RoHS).

The communication module that comes with the inverter and the technical parameters of wireless communication are listed in the table below. The model of the communication module actually delivered shall prevail. The EU Declaration of Conformity for the communication module can be found at support.sungrowpower.com.

WiNet-S/WiNet-S2:

Radio technology	WLAN 802.11b/g/n20/n40	
Radio spectrum	802.11b/g/n20	2412 MHz ~ 2472 MHz
	802.11n40	2422 MHz ~ 2462 MHz
Maximum transmission power	≤ 20 dBm	

Technical parameters listed above apply to EU countries only.

Manufacturer : Sungrow Power Supply Co., Ltd.
No 1699, Xiyou Road, Hefei 230088, P.R.China
For EU only
EU/EEA Importer: Sungrow Deutschland GmbH
Balanstraße 59, 81541 München, Germany

Security Declaration

For details on the product's network security vulnerability response process and vulnerability disclosure, please visit the following website:
<https://en.sungrowpower.com/security-vulnerability-management>

For more information on network security, please refer to the user manual of the communication module or the Data Logger that comes with the product.





More information in the QR code or
at <http://support.sungrowpower.com/>

SUNGROW

Sungrow Power Supply Co., Ltd.

www.sungrowpower.com



M 0 H 0 1 4 0 4 0 0 - 6