

User Manual

iSolarCloud O&M

iSolarCloud

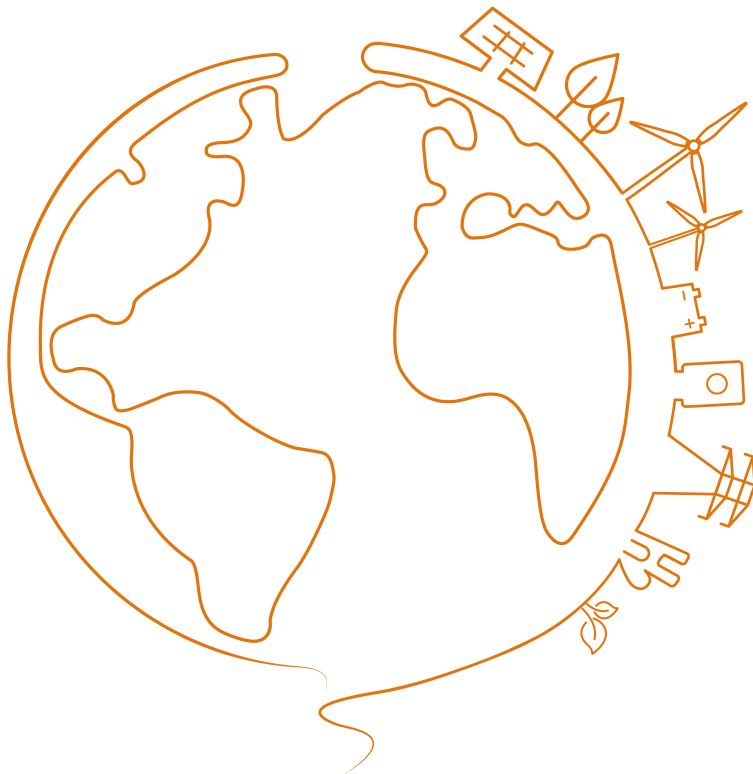

All Rights Reserved

All Rights Reserved

No part of this document can be reproduced in any form or by any means without the prior written permission of Sungrow Power Supply Co., Ltd (hereinafter "SUNGROW").

Trademark

SUNGROW and other Sungrow trademarks used in this manual are owned by SUNGROW. All other trademarks or registered trademarks mentioned in this manual are owned by their respective owners.

Software Licenses

- It is prohibited to use data contained in firmware or software developed by SUNGROW, in part or in full, for commercial purposes by any means.
- It is prohibited to perform reverse engineering, cracking, or any other operations that compromise the original program design of the software developed by SUNGROW.
- To further optimize our service system and clarify service boundaries, iSolarCloud does not provide remote monitoring services for devices installed in the United States or Canada. If you choose to use any iSolarCloud-related services in these regions by any means, you shall bear full responsibility for any resulting issues, disputes, losses, or liabilities.

About This Manual

Target Group

This manual gives instructions for users on how to perform operation and maintenance on devices in the plant through the iSolarCloud O&M management platform. Functions such as plant management, device management, O&M tools, reports, warranty inquiry, and customer service management are available on this platform.

This manual is intended for:

- Retailer/Installer
- Owners
- O&M personnel
- After-sales service team

Requirements

Item	Requirement
Browser	Chrome 60 or later (recommended); Safari 10 or later, Firefox 60 or later (supported)
Resolution	1920 * 1080 (recommended); 1366 * 768 (supported)



User interfaces presented in this manual come from V1.4.6.20240130. They are for reference only and may deviate from the user interface you actually see.

Contents

All Rights Reserved.....	I
About This Manual.....	II
1 Common Operations.....	1
1.1 Create Account.....	1
1.2 Log in to an Account.....	3
1.3 Reset Password.....	4
1.3.1 Reset Password via Phone Number/Email.....	4
1.3.2 Reset Password via Device S/N.....	5
2 Plant.....	6
2.1 Plant List.....	6
2.2 Create Plant.....	8
2.2.1 Create One Plant.....	9
2.2.1.1 Complete Plant Information.....	9
2.2.1.2 Add communication device.....	11
2.2.1.3 Set tariff.....	12
2.2.2 Create Plants in Batch.....	13
2.3 Plant Details.....	14
2.3.1 Overview.....	14
2.3.1.1 C&I PV-Charging Plant Overview.....	17
2.3.1.2 C&I PV-ESS-Charging Plant Overview.....	18
2.3.1.3 C&I ESS Plant Overview.....	20
2.3.2 C&I ESS Plants in Full-Screen Mode.....	20
2.3.3 Charger.....	22
2.3.3.1 With Data Logger.....	22
2.3.3.2 With iHomeManager or Communication Module.....	23
2.3.4 Layout.....	27
2.3.4.1 Check Device Status.....	28
2.3.4.2 View Device Information.....	30
2.3.4.3 Auto Optimizer/RSD Search.....	32
2.3.4.4 Inverter Settings.....	33
2.3.4.5 Export Layout.....	35
2.3.5 Plant Device.....	35
2.3.5.1 View C&I ESS Information.....	38
2.3.5.2 View C&I Energy Storage Battery Cabinet Information.....	39

2.3.5.3 Configure Third-Party Device Parameters.....	41
2.3.6 Fault.....	44
2.3.7 Data Analysis.....	44
2.3.7.1 Device Curve.....	44
2.3.7.2 Revenue Deviation Curve.....	45
2.3.7.3 Demand Analysis.....	46
2.3.7.4 Power Following.....	47
2.3.7.5 Load Following.....	48
2.3.7.6 Charging/Discharging Statistics.....	48
2.3.8 Parameter Settings.....	49
2.3.8.1 Quick Setting.....	49
2.3.8.2 Device Parameters.....	62
2.3.8.3 Plant Information Setting.....	63
2.3.8.4 Set Tariff	64
2.3.9 Layout Settings.....	66
2.3.9.1 Layout Setup for C&I PV Plant.....	66
2.3.9.2 Layout Setup for Residential PV Plant.....	73
2.3.9.3 Replace/Delete/Add Optimizer or RSD.....	74
2.3.10 Firmware Update.....	76
2.3.11 Live data.....	76
2.3.12 IV Curve Online Diagnosis.....	76
2.3.13 Strategy Configuration.....	76
2.3.13.1 Energy Management.....	77
2.3.13.2 Power Control.....	106
2.3.13.3 System Settings.....	123
2.3.14 Plant Report.....	128
3 Device.....	129
3.1 Device List.....	129
3.2 Fault List.....	130
3.3 Parameter Setting.....	132
3.3.1 Initial Grid Connection.....	132
3.3.2 Common Settings.....	133
3.3.2.1 Common Data Logger Settings.....	135
3.3.2.2 Common iHomeManager Settings.....	149
3.3.2.3 Common Parameter Settings of Energy Management System....	160
3.4 Firmware Update.....	162
4 Maintenance.....	164
4.1 Curve.....	164
4.1.1 Plant Comparison.....	164
4.1.2 Device Comparison.....	166

4.1.3 Customized Comparison.....	167
4.2 Intelligent Analysis.....	168
4.2.1 Input Value Dispersion Ratio Analysis.....	168
4.2.2 Analysis of Inverter Output Dispersion Rate.....	170
4.2.3 Plant's Daily Load Curve.....	171
4.3 Remote Maintenance.....	171
4.4 Live data.....	172
4.5 IV Curve Online Diagnosis.....	173
4.5.1 Parameter Setting.....	174
4.5.2 Advanced Settings.....	175
4.5.3 Unit Scan.....	176
4.5.4 Inverter Scan.....	178
4.6 Fault Response Plan.....	178
4.7 Plant Operation Report.....	180
5 Report.....	182
5.1 Custom Report.....	182
5.2 System Reports.....	184
5.2.1 Plant Report.....	185
5.2.2 Yield Report.....	186
5.2.3 Inverter Report.....	187
5.2.4 ESS Time-of-Use Electricity Report.....	187
5.2.5 ESS Revenue Report.....	188
5.2.6 ESS Demand Revenue Report.....	189
5.3 Export Records.....	190
5.4 Report Subscription.....	190
6 System.....	193
6.1 Plant Sharing.....	193
7 Support.....	195
7.1 Warranty Query.....	195
7.2 Push Notifications.....	195
7.2.1 Alarm Subscribe.....	195
7.2.2 Smart Alarm Analysis Setting.....	197
7.2.3 Offline Notifications.....	197
7.3 Help Center.....	198
8 Message Center.....	199
9 Account Management.....	200
9.1 Profile.....	200
9.2 Account and Security.....	200
9.3 Notifications.....	200

9.4 General Settings.....	201
9.5 Manufacturer Information.....	201
9.6 About.....	201
9.7 Back to Old Version.....	201
9.8 Logout.....	201
10 Feedback.....	202

1 Common Operations

1.1 Create Account

This section introduces how to create an owner or retailer/installer account in iSolarCloud.

Prerequisites

The iSolarCloud system functions properly and the network connection between the computer and server is normal.

Context

User roles include the owner and the retailer/installer.

Owner: Users who already have or are about to have a power plant of their own.

Retailer/Installer: Users who provide owners with services such as plant creation and O&M.

Step 1 In the browser address bar, enter <https://web3.isolarcloud.com> to go to the login page.

Step 2 Click **Register** for account registration.

Step 3 Select the server and account type.

The screenshot displays the registration process in two steps:

- 01 Account information** — 02 Detailed information
- 01 Select your server**
Please select the server for your area; if none is available, choose the international server
International server
- 02 Please select your role**
Retailer/Installer (selected) and Owner
- Next

Note

Users in the Chinese mainland may choose the **Chinese server** and can only create retailer/installer accounts using phone numbers.

Users in Europe may choose the **European server** and can create owner and retailer/installer accounts using email addresses. Applicable countries/regions include:

- Denmark, Iceland, Norway, Sweden, Finland, Bosnia and Herzegovina, United Kingdom, France, Ireland, Netherlands, Belgium, Luxembourg, Monaco, Germany, Austria, Switzerland, Poland, Czech Republic, Hungary, Slovakia, Liechtenstein, Belarus, Ukraine, Lithuania, Estonia, Latvia, Moldova, Russia, Greece, Italy, Spain, Portugal, Romania, Bulgaria, Serbia, Croatia, Slovenia, Montenegro, Albania, Vatican City, San Marino, Malta, Andorra, North Macedonia, Israel, Turkey, and Cyprus.

Users in Australia may choose the **Australian server** and can create owner and retailer/installer accounts using email addresses. Applicable countries/regions include:

- Australia, Papua New Guinea, Fiji, Kiribati, Marshall Islands, Nauru, Samoa, Solomon Islands, Tonga, Tuvalu, Vanuatu, and New Zealand.

Users in other regions may choose the **International server** and can create owner, retailer, and installer accounts using email addresses.

Step 4 Complete the required information.**Table 1-1** Information Required to Create an Account

Parameter	Description
Phone number or Email*	Register using your phone number if you have selected the Chinese server . Register using your email if you have selected the International server , European server , or Australian server .
Verification code*	Enter your Phone number or Email , and click Send . Then, enter the verification code you have received.
Username	User-definable, used for login.
Password and Confirm password*	The password should be 8–32 characters long and contain numbers, letters, or special characters.
Country/region*	The country or region where the user is located.
Company name	The company where the retailer/installer belongs to.

Parameter	Description
Upper-level retailer/installer code	The organization code of the upper level service provider. You can contact your upper-level retailer/installer for this code. If this code is entered, your upper-level retailer/installer will be able to view and manage the plants under your account management (except for the plants that are shared with you).



Fields marked with an asterisk (*) are required.

Step 5 Agree to the privacy policy and click **Confirm**. Your account is now created.

--End

1.2 Log in to an Account

Prerequisite

This section gives a step-by-step instruction on how to log in to the iSolarCloud system.

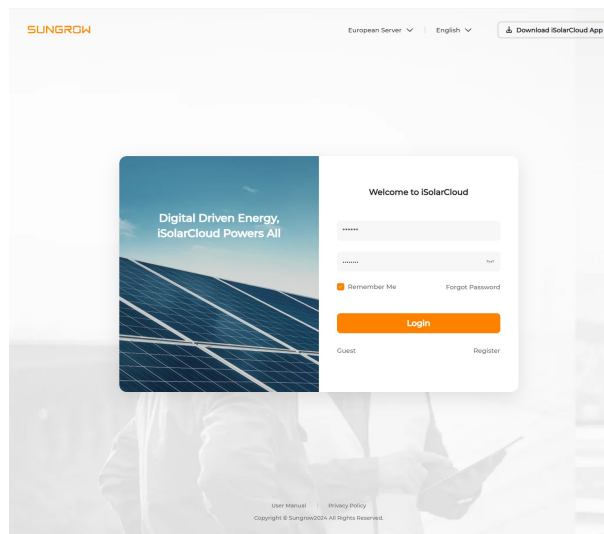

Step 1 Enter <https://web3.isolarcloud.com> in the address bar of a browser.

Step 2 You can change the server and system language in the upper right corner of the page. Users in mainland China may choose **Chinese Server**. Users in Europe may choose **European Server** and those in Australia may choose **Australian Server**. Users in other countries/regions may choose **International Server**.

Step 3 Enter the account name and password on the login page, and click **Login**. You may select the **Remember Me** checkbox so that you will not need to enter the password at the next login.

--End

1.3 Reset Password

Step 1 Click **Forgot Password** on the login page.

Step 2 Three options are available for users to reset the password: **Retrieve via Phone Number**, **Retrieve via Email**, and reset via **Device S/N**.



If you have selected the **Chinese Server**, you may choose **Retrieve via Phone Number** or **Retrieve via Email**.
If you have selected the **International Server**, **European Server**, or **Australian Server**, you can only choose **Retrieve via Email**.

--End

1.3.1 Reset Password via Phone Number/Email

Retrieve via Email

* Email
Please Enter

* Verification Code
Please Enter

* New Password * Confirm New Password

1 Verification code not received by email?

1. The verification email has not been sent due to a delay or other reasons.
2. The verification email is treated as junk mail by the server and is automatically transferred to the trash box. You may check the trash box for the verification email.
3. You may click Resend or change to another email.
4. If the verification code has not been received after several times, please select other verification methods. If you have forgotten your email address, please "Retrieve via Device S/N".

Step 1 Enter your **Phone Number** or **Email**, and click **Send**. Then, enter the verification code you have received through text message or email.

Step 2 Enter a **New Password**, and then **Confirm New Password**. The password shall be 8–32 characters long and contain numbers, letters, and symbols.

Step 3 Click **Confirm**, and you will go back to the login page. Now you can log into the system using your new password.

--End

1.3.2 Reset Password via Device S/N

In case you forgot the phone number or email used to create the account, you may reset your password using the S/N of any inverter or communication device that has been added to the account.

The screenshot shows a web form titled '< Retrieve via Device S/N'. It contains four input fields: 'Account', 'Device S/N', 'New Password', and 'Confirm New Password'. Each field has a 'Please Enter' placeholder and a small 'x' icon on the right. Below the fields is a blue box with an information icon and the text 'Forgot Account/Device S/N? Please contact Sungrow Customer Service to retrieve your password. Contact method:400 119 7799'. At the bottom center is a 'Confirm' button.

Step 1 Click **Retrieve via Device S/N**.

Step 2 Enter your **Account** and **Device S/N**.

Step 3 Enter a **New Password**, and then **Confirm New Password**. The password shall be 8–32 characters long and contain numbers, letters, and symbols.

Step 4 Click **Confirm**, and you will go back to the login page. Now you can log into the system using your new password.

--End

2 Plant

After logging in to the web system, click **Plant** in the side navigation bar. You will then go to the page as shown below .

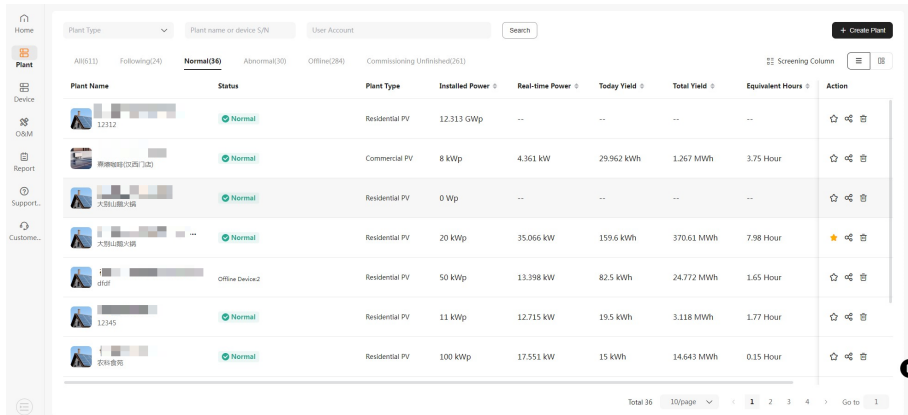

Figure 2-1 Plant

2.1 Plant List

On this page, you can view information such as the status, installed power, real-time power, and yield data of the plants. You can also follow, share, or delete a plant.

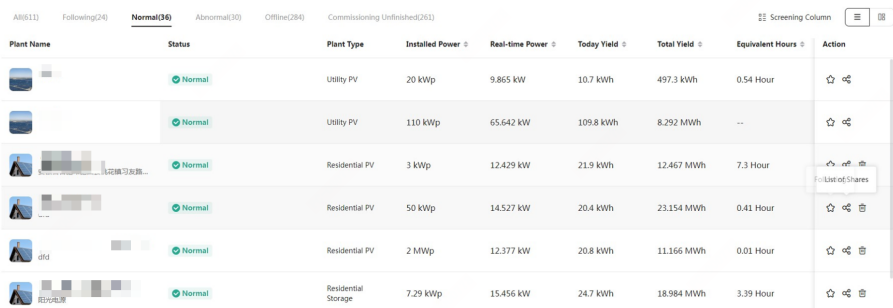



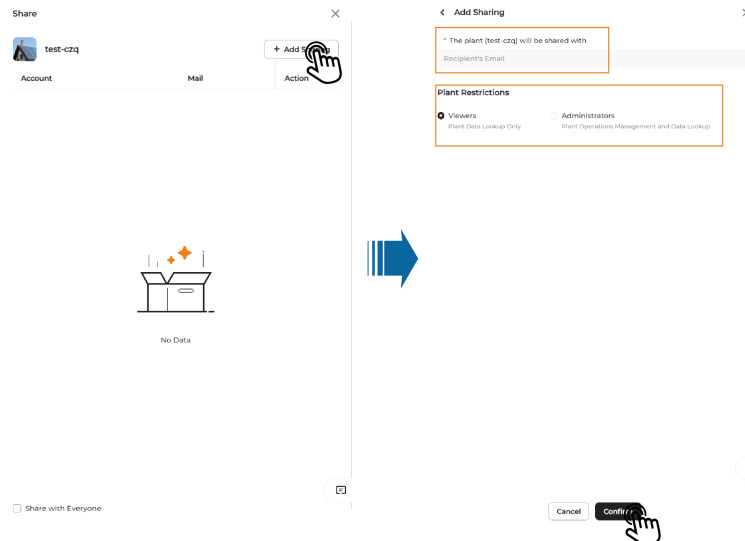



Figure 2-2 Plant List

Procedure

- Search for a plant
 - Search by region: Click **All Regions**, and select the name of the organization where the account belongs and its subordinate organization. A list of plants that meet the search criteria will then be shown on the screen.



- Search by plant information: Select the **Plant Type**, and enter the **Plant name or device S/N** and **User Account**. Click **Search**, and a list of plants that meet the search criteria will be shown on the screen.
- Search by equivalent hour: Click **Filter**, set the **Min Value** and **Max Value** of equivalent hours, and click **Confirm**. A list of plants that meet the search criteria will then be shown on the screen.
- Search by device: Click **Filter**, select **Optimizer** or **RSD** in “Devices of the Plant”, and click **Confirm**. Plants that meet the search criteria will then be shown on the screen.
- Switch between the list view and card view
 - Click  in the upper right corner to show the plants under the current account in a list view.
 - Click  in the upper right corner to show the plants under the current account in a card view.
- Follow a plant
 - Click  to follow a plant. You may check the plants you have followed in the “Following” list.
 - You may click  to unfollow a plant.
- Share a plant



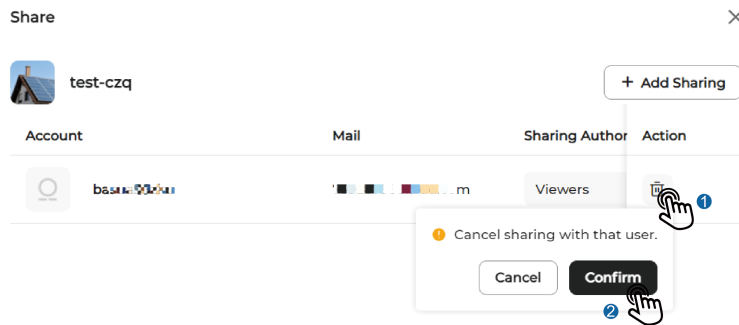

1. Click  in the action column to open the “Share” panel.
2. Click **Add Sharing**, enter the mobile phone number bound to the shared user account, and assign permissions in **Plant Restrictions** accordingly.
 - Viewers: Plant data lookup only.
 - Administrators: Plant operation management and data lookup.
3. Click **Confirm** to share the plant.

- Stop sharing a plant



1. Click  in the Action column to open the “Share” panel.
 2. Find the user to be removed, and click .
 3. Click **Confirm**. The plant will no longer be shared with this user.
- Delete a plant

Click  to delete the corresponding plant.

 Deleted plants cannot be recovered. Please proceed with caution.

2.2 Create Plant

Go to the “Plant” page and click **Create Plant** in the upper right corner. You may choose to create one plant, or create multiple plants at a time.

2.2.1 Create One Plant

2.2.1.1 Complete Plant Information

Step 1 Select a plant type according to the actual situation.

Step 2 Fill in the plant information. The information may vary by plant types.

Table 2-1 Residential PV, Residential ESS, C&I PV, and Microgrid

Parameter	Description
*Plant name	Enter the plant name. For how to change the name after plant creation, see 2.3.8.3 Plant Information Setting .
*PV installed power (kWp)	Enter the actual PV installed power.
*Detailed address	Enter the specific location of the plant.
*Country/region	Select the country/region where the plant is located.
*Time zone	This field will be auto-filled according to the country/region you have selected.
*Grid connection type	Select the grid-connection type according to the actual situation.

Parameter	Description
Grid connection date	Select the date when the devices in the plant are connected to the grid.
*Energy storage solution	This field is required when Plant type is set to Microgrid . You can select DC coupling or AC coupling .
Postal code	The postal code of the location where the charging pool is located.
Plant image	You may upload a photo of the plant.
*Owner's email address	Assign an owner to the plant. You can use an email address that is new or already registered with iSolarCloud. When the plant is successfully created, iSolarCloud will automatically create an account for the new owner and send it to the owner by SMS.
PV module model	Choose the model actually used in the plant. You can search by module manufacturer, module model, or maximum power. Click Add to manually include an expected model if not found.
NMI	Fill in this field when Country/region is set to Australia.

Table 2-2 C&I ESS Type

Parameter	Description
*Plant name	Enter the plant name. For how to change the name after plant creation, see 2.3.8.3 Plant Information Setting .
ES installed power (kW)	Enter the actual power of the DC/AC power converter unit.
ES battery capacity (kWh)	Enter the actual ES battery capacity.
PV installed power (kWp)	Enter the PV installed power.
*Detailed address	Enter the specific location of the plant.

Parameter	Description
*Country/region	This field will be auto-filled according to the detailed address you have selected.
*Time zone	This field will be auto-filled according to the detailed address you have selected.
Plant image	You may upload a photo of the plant.
*Owner's email address	Assign an owner to the plant. You can use an email address that is new or already registered with iSolarCloud. When the plant is successfully created, iSolarCloud will automatically create an account for the new owner and send it to the owner by SMS.

 Fields marked with an asterisk (*) are required.

Click **Import from iSolarDesign** to import projects that have been completed in iSolarDesign.

Import plant from iSolarDesign Please select a completed project in iSolarDesign to import plant information ×

Project name

Project name	Update time	Address
<input type="radio"/> [Redacted]	2025-08-12 18:03:45	[Redacted]
<input type="radio"/> [Redacted]	2025-08-08 13:28:38	[Redacted]

Total 2 20/page < 1 > Go to 1

After completing the plant information, click **Next**. If the project includes a physical layout, you can import the layout diagram.

--End

2.2.1.2 Add communication device

Step 1 Navigate to the **Add communication device** Page.

Step 2 Two methods are available to add a communication device:

- a. Add manually: Select the device type, enter the S/N of the communication device, and click **Add**.
- b. Scan a QR code: Click **Identify QR code**. Upload a picture of the device's QR code, or drag and drop the picture to the box for QR code identification.

--End

2.2.1.3 Set tariff

Step 1 Navigate to the **Tariff** page.

Step 2 Select a currency from the **Currency** drop-down list.

Step 3 Set **Consumption tariff**.

You can select from the following tariff types:

- Fixed tariff: The same tariff applies to all time periods.
- Time-of-use tariff: You can set different rates for electricity consumed in different time windows of day. The time windows cannot overlap.

- Time-of-use tariff (Working days+Non-working days): You can set different time periods and corresponding tariffs separately for working days and non-working days.

- Tiered tariff: You can configure different consumption tiers and corresponding tariffs for each time period.

Tiered electricity consumption(kWh)	Tariff(ALL/kWh)	Action
0-100	Enter here	+
Above 100.00	Enter here	⊗

Step 4 Set **Feed-in tariff**: Similar to setting **Consumption tariff**. Choose the appropriate tariff billing method.

Step 5 Click **Complete**.

--End

2.2.2 Create Plants in Batch

Create Plants in Batch can be used to create more than one residential PV plant at a time.

Step 1 Go to the “Create Plant” page and choose **Create Plants in Batch** at the upper left.

Step 2 Select the **Country/Region** where the plant is located. The **Time Zone** will be auto-filled based on the country/region you have selected.

Step 3 Click **Download Table Template** to download and save the template file locally. Then, fill in the plant information by referring to the “Note” in the template file, and save.

Owner's Name <small>(Required)</small>	Phone	Email <small>(Required)</small>	S/N <small>(Required)</small>	Installed Power (kWp) <small>(Required)</small>	Grid-connection Date	Plant Address	Longitude	Latitude
Jack	1380007553	cool@as.com	A111999999	1000	2019/1/11	xx	38.87350167	115.0202798

Note:

- Mobile phone number: Chinese users must fill in this information, and it must be true and valid.
- Email: required for overseas users, and must be true and valid.
- Installed power of the power station. The default unit is kW. This data is the basic index of the calculation data, which affects the calculation of the basic data of the power station and needs to be filled in correctly.
- Grid-connection date: fill in the format of YYYY/MM/DD.
- The weather of the power station is obtained according to the latitude and longitude. It can be obtained according to the tigantia map. It is recommended to fill in.

Step 4 Click **+** to upload the file.

Step 5 Click **Create Plant** to create multiple plants at a time.

--End

2.3 Plant Details

Click on a plant name on the “Plant” page. You can then check the information about the plant, the devices in the plant, and the faults, and complete the plant configuration settings.

2.3.1 Overview



The information on the user interface may vary by plant type, and the actual page shall prevail.

Click a plant name on the **Plant** page to go to the **Overview** page, where you can view the plant details.

Procedures

- View the power flow diagram.

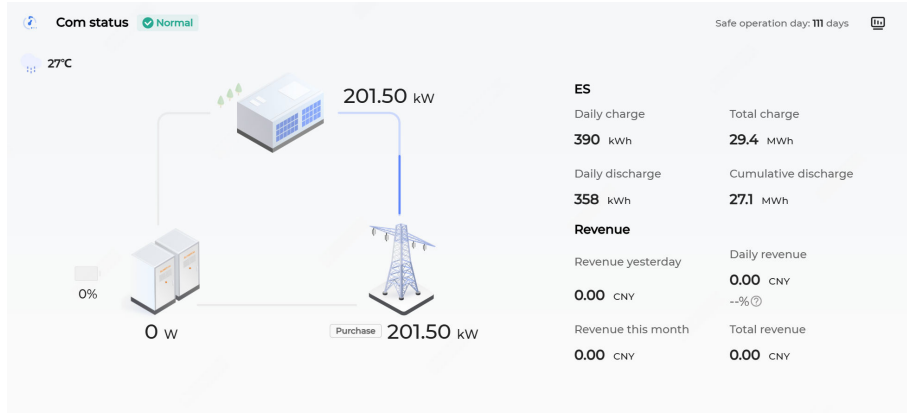

Information such as PV output power and feed-in power is shown. Arrows between the icons indicate energy flow between the devices. The direction of the arrow indicates the direction of energy flow.

i In the residential energy storage system (ESS), if the battery is being heated, the power flow diagram shows the battery heating status  .

- View and set the energy management mode.

i In the ESS scenarios, when the plant operates in the energy management mode, and the communication device includes a Data Logger, iHomeManager, or other energy management systems, the screen displays the current energy management mode.

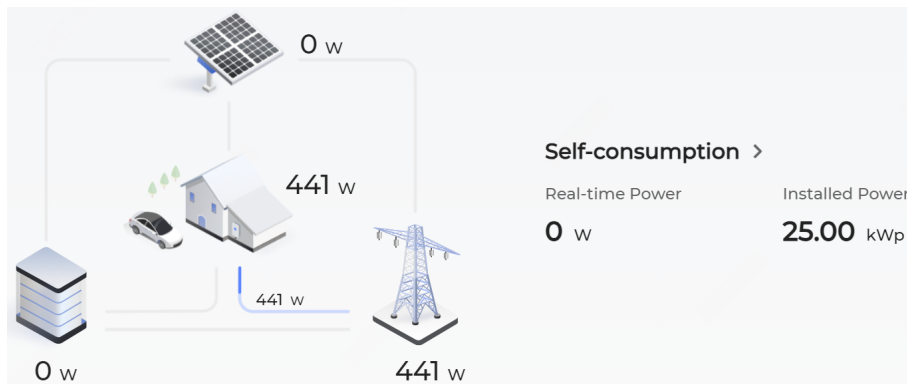

Click the energy management mode for more settings.

To configure Data Logger energy management, refer to [3.3.2.1.2 Energy Management](#), for iHomeManager energy management, refer to [3.3.2.2.1 Energy Management](#), and for other energy management systems, refer to [2.3.13 Strategy Configuration](#).





When the AI mode is enabled, the screen displays the revenue increase rate in the mode. Click the rate to go to the energy management screen and view more details about the increase.

The displayed revenue increase rate is calculated by iSolarCloud based on its algorithms and may differ from the actual data.

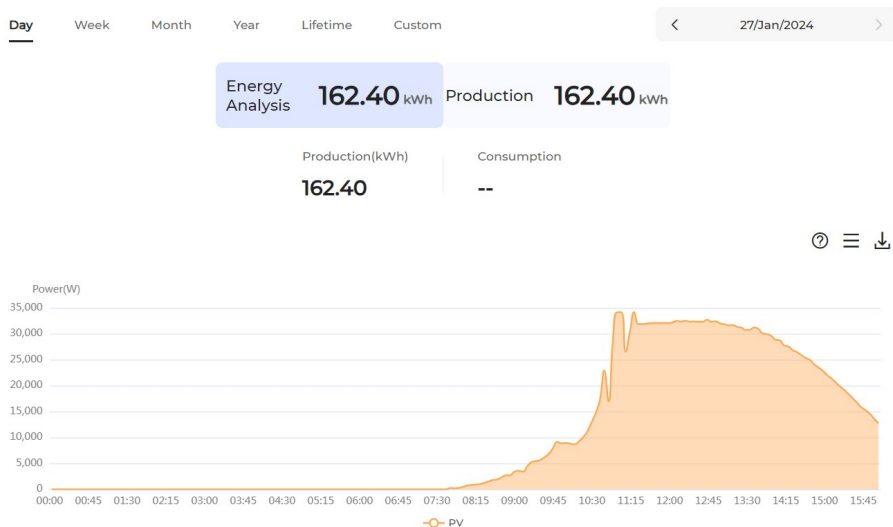
- View the charger details.
When the plant is equipped with chargers, click on any one of the chargers in the power flow diagram for details. See [2.3.3 Charger](#) for more.
- View revenue.
The **Overview** page displays data including **Revenue yesterday**, **Daily revenue**, **Expected revenue deviation today**, **Revenue this month**, and **Total revenue**.
- View and export production and consumption data.



1. Click **Day**, **Week**, **Month**, **Year**, **Lifetime**, or **Custom** to view statistical data of different time periods.
2. Proceed as follows based on the actual situation.
 - Click the icons in the upper right corner of the page to change the format of data display. Choose  to view data in a chart and choose  to view data in a table.
 - Click  to export the plant data to an Excel or CSV file.
- View the plant net revenue.
 - Click **Day**, **Week**, **Month**, **Year**, **Lifetime**, or **Custom**, specify a time period, and choose **Net revenue** for the amount.
- Check the plant's contribution to emission reduction.

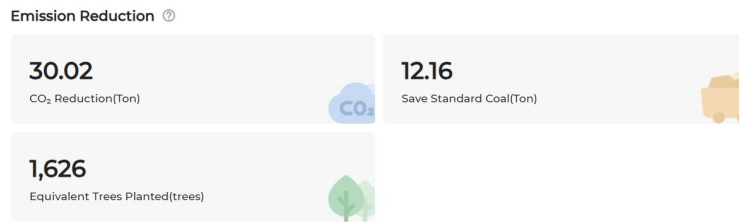

1. The lower part of the **Overview** page displays how the plant contributes to energy saving and carbon emission reduction, including data on **CO₂ reduction**, **Standard coal saved**, and **Equivalent trees planted**.
2. Click the icon ⓘ to check how the system calculates the plant's contribution to energy saving and emission reduction. You can click the icon ✎ to set the coefficient, based on which the CO₂ emission reduction is calculated, ranging from 0.1 to 10. If the checkbox **Clear all history data** is selected, the amount of CO₂ emission reduction, since the plant was first connected to iSolarCloud, will be recalculated based on the new coefficient. If the checkbox is not selected, the coefficient will be applied to calculate future emission reduction only.

CO₂ Reduction ✕

* Coefficient Setting

0.997

Setting Range for Reference: 0.1-10

Are you sure you want to clear all history data?

Recalculate the CO₂ reduction since the plant was connected to iSolarCloud.

Cancel Confirm

2.3.1.1 C&I PV-Charging Plant Overview

- View the power flow



The power flow diagram displays information such as PV output power, DC charger charging power, and feed-in power.

- View and set the **Charging Mode**
The **Overview** page displays the **Charging Mode**. You can click the current charging mode to enter the **Charging Management** page and set the **Charging Mode**. For details about how to set the **Charging Mode**, see [3.3.2.1.1 Charging Management](#).
- View the power and energy data of the DC charger

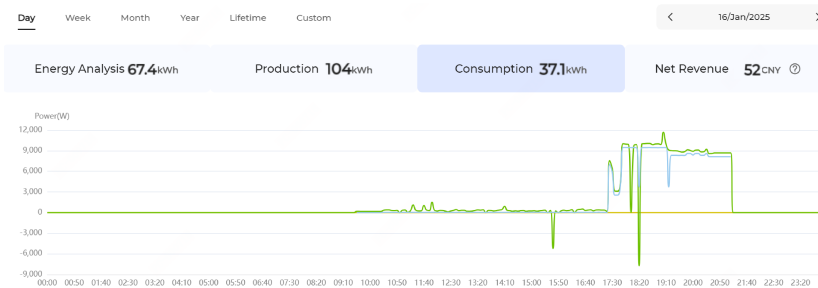

2.3.1.2 C&I PV-ESS-Charging Plant Overview

- View the power flow diagram: Displays the power information about PV output, batteries, chargers, and loads. Arrows between the icons indicate the energy flowing between the devices. The direction of the arrow indicates the direction of the energy flow.

European server, international server, and Australian server: The power flow diagrams take different forms according to the connected batteries or ESS.

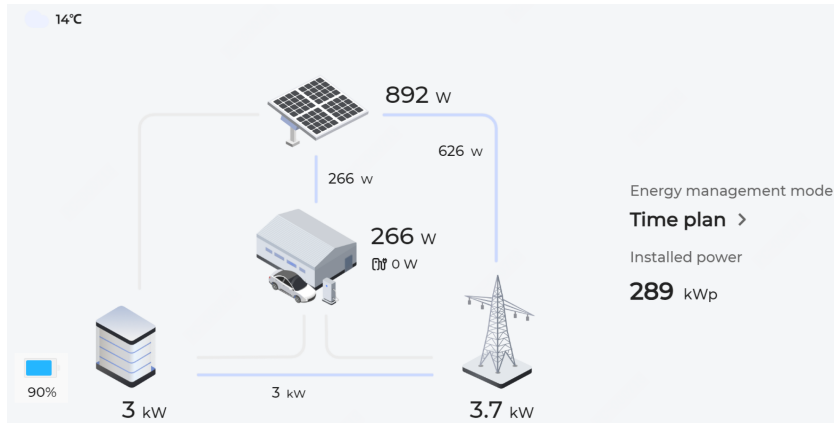

Chinese server

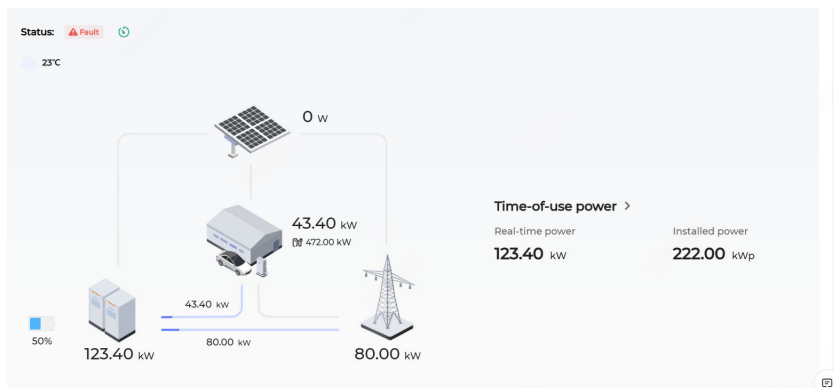

- View the charger details.
When Logger1000 is connected to a commercial and industrial (C&I) ESS plant, click the charger icon in the power flow diagram to directly go to the **Charger** page for more details.
- Check data about the ESS and diesel generators.
When EMS300CP is connected to a C&I ESS plant, click the ESS or the diesel generator icon in the power flow diagram to directly go to the page for corresponding details.
- View and set energy management mode.
The **Overview** page displays the current **Energy management mode** for more settings. When EMS works as the energy management master control device, the configurable parameters may vary by server, and parameters on actual pages shall prevail.

Server	Configuration Details
Chinese server, European server, and	For details about how to set the energy management mode, see 2.3.13 Strategy Configuration .

Server	Configuration Details
International server	
Australian server	For details about how to set the energy management mode, see 3.3.2.3 Common Parameter Settings of Energy Management System .

When Logger1000 works as the energy management master control device, see [3.3.2.1.2 Energy Management](#) for how to configure the energy management mode.

2.3.1.3 C&I ESS Plant Overview

- View power flow

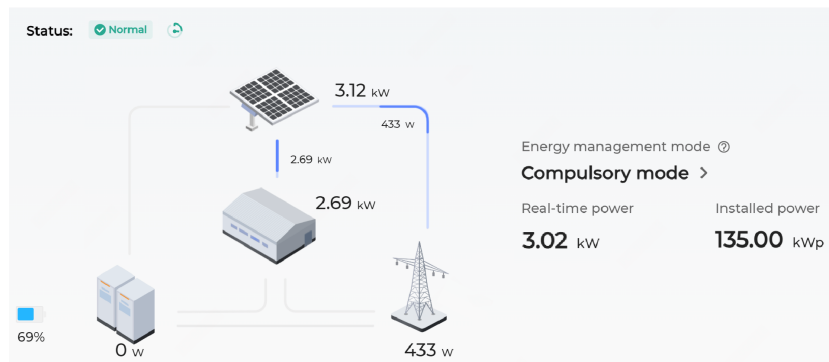

The power flow diagram displays information such as PV output power, energy storage battery power, and feed-in power.

- View and set energy management mode
The Overview page displays the **energy management mode**. For configuration instructions, please refer to [2.3.1 Overview](#).

2.3.2 C&I ESS Plants in Full-Screen Mode

The full-screen mode enables you to have an overview of the current plant, along with the details of the PV, ESS, and charging tabs, with a tab carousel.

Navigation Path

Click any one of the C&I ESS plants on the **Plant** page to go to the **Overview** page, and then choose the icon  in the upper right corner of the power flow diagram to access the full screen.





It is only supported for C&I ESS plants.

Description

- Overview tab: Displays the energy flow diagram and the default indicators, as well as faults today, revenue statistics, power curves, power analysis, SOC curves, and social contribution.
- PV tab: Displays PV power curves, power analysis, inverter generation ranking, and inverter details. The power analysis shows monthly, annual, and total yield.
- ES tab: Displays ESS power curves, power analysis, and ESS device details. The power analysis shows monthly, annual, and total yield.
- Charger tab: Displays chargers' power curves, power analysis, and charger details. The power analysis shows monthly, annual, and total yield.

Custom Page Layout

Click the profile in the upper right corner of the page, choose **Settings**, and choose either **Homepage configuration** or **Icon settings**.

- Customize the display on the **Overview** tab:
 - Change the load images: Choose images for either **C&I parks** or **Office buildings** based on the actual plant loads.
 - Set the **Page transition interval** for the tab carousel. Options include **30s**, **60s**, and **No carousel**.
 - Customize the tile display: Long-press the icon  in the upper left corner of each tile to drag and drop it to a different location on the screen and display it in a different format. Tiles in the **Available** area are not displayed.
 - Edit tiles: Click the icon  to modify the tile name. Hover the cursor over a certain tile to **Select indicator** or define **Figure transition interval**.

- Icon settings: Click **Upload** to choose a customized logo or system name from your local machine. Upon completion, they will be displayed in the upper left corner of the full screen.

Click **Save** to save the settings.

2.3.3 Charger

Click a plant name on the **Plant** page, and you will go to **Overview** by default. Choose **Charger** on the left.

Permissions for the charging settings may vary between an owner and a retailer/installer, and the supported functions in an actual account shall prevail.



The supported functions and configurations on the **Charger** tab are subject to the communication devices connected to the plant.

- If the plant is equipped with iHomeManager or WiNet-S/S2, a communication module, refer to [2.3.3.2 With iHomeManager or Communication Module](#) for details about the tab and relevant settings.

2.3.3.1 With Data Logger

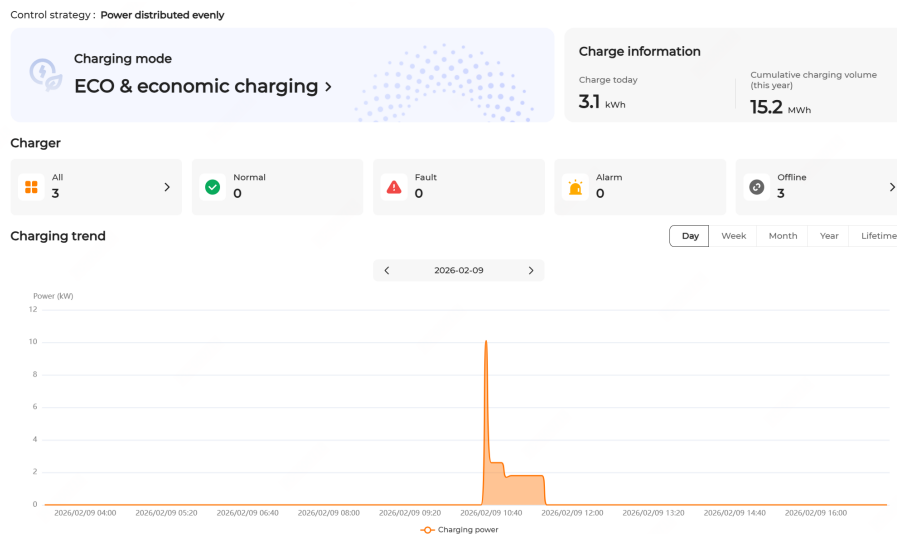

If the plant is equipped with a Data Logger, the **Charger** page allows you to view and configure the following information:

- View and set the charging mode. Click **Charging mode** to view and configure the relevant details. For details, see [3.3.2.1.1 Charging Management](#).



Only an owner can configure the charging mode.

- View the charging information.

- View the charger details: The statuses of all the chargers in the plant are displayed. You can click one of the statuses to enter the **Device** page and filter out all the chargers in that status.

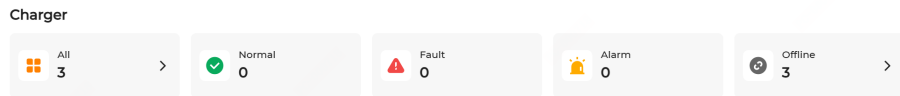

2.3.3.2 With iHomeManager or Communication Module

If the plant is equipped with iHomeManager or a communication module, the **Charger** page allows you to view the charging data, including charger status, time, and power.



If the charger status shows **Unplugged**, the charging connector may not be properly plugged into the EV. In this case, check the connection, or pull out and plug the charging connector again.



Charger details and supported functions on different servers may differ, and the actual page shall prevail.

2.3.3.2.1 Charger Settings (European Server)

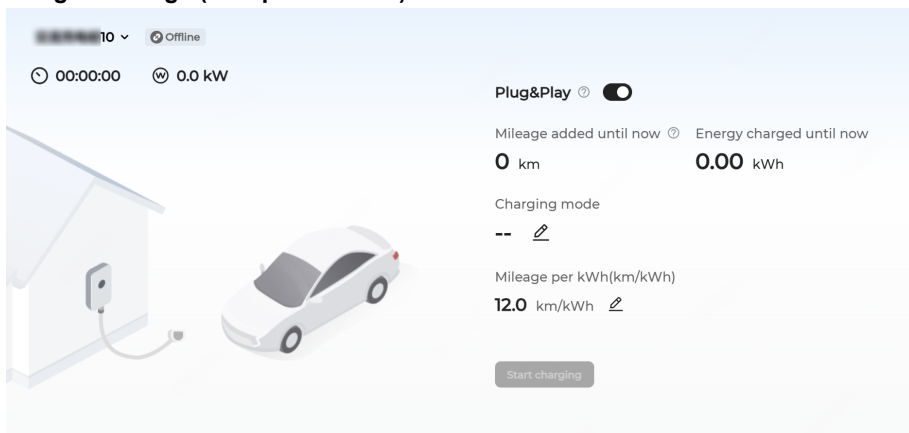

Step 1 (Optional) If necessary, click the drop-down list in the upper left corner of the page to switch chargers.

Step 2 Turn on or off **Plug&Play**.

- On: Charging begins once the charging connector is plugged into the EV.
- Off: After the charging connector is plugged into the EV, the user needs to click **Start charging** to charge.

Step 3 Set the **Charging mode**.



This mode applies to all chargers in the plant.

Table 2-3 Different Charging Modes

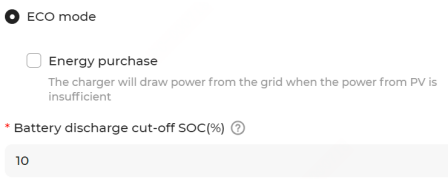
Charging Mode	Description
ECO mode	<p>Economical charging.</p> <p>In this mode, the system prioritizes supplying other loads with PV output and, when there is excess feed-in power, directs the charger to charge the EV.</p> <p>Complete the following settings:</p>  <ul style="list-style-type: none"> • Energy purchase: When the option is turned on and the PV output and battery energy are insufficient, the EV can be charged with energy purchased from the grid. • Battery discharge cut-off SOC (%): Available only when Energy purchase is disabled. When the PV output power cannot cover the demand, the battery discharges to compensate for the gap until this SOC threshold is reached. When the system SOC is above this threshold, the battery is allowed to discharge to supply the charger. When the system SOC is below this threshold, the battery is not allowed to discharge to supply the charger.
Fast charging	<p>Charge at the maximum charging power of the charger.</p> <p>You can select this mode to quickly charge the EV in case of urgency. In this mode, when the PV output power is not sufficient to meet the charging demand, the system supplies battery energy to the charger. If the battery capacity is insufficient, the system purchases energy from the grid to fulfill the gap.</p>
Scheduled charging	<p>According to the values Need to use vehicle at and Charging target, the system automatically switches between ECO charging and fast charging, and completes charging at the minimum electricity cost before you pick up the car.</p>
Customized charging	<p>You can set Start time, End time, and Current/power. In this mode, when the PV output power is not sufficient to meet the charging demand, the system supplies battery energy to the charger. If the battery capacity is insufficient, the system purchases energy from the grid to fulfill the gap.</p>

Step 4 Set **Control strategy**. Allocate power across chargers based on the preset strategy to meet users' varying charging demands. Up to 3 chargers can be connected.

- **First come first charged** (default): Based on the charging order of the charger and grid power limits, the system allocates power according to EVs' actual needs, prioritizing earlier comers.
- **Power distributed evenly**: Allocate charging power evenly according to the EV quantity and grid power limits.

Step 5 Specify **Mileage per kWh**, which indicates how far a car can travel on 1 kWh of energy. It depends on the actual road conditions, the vehicle model, the weight of the vehicle and the load it carries, and the speed of the vehicle.

Step 6 Click **Start charging**, and the charger status changes to **Charging**.

Click **Stop charging**, and the charger status changes to **Charging complete**.

--End

2.3.3.2.2 Charger Settings (Australian Server)

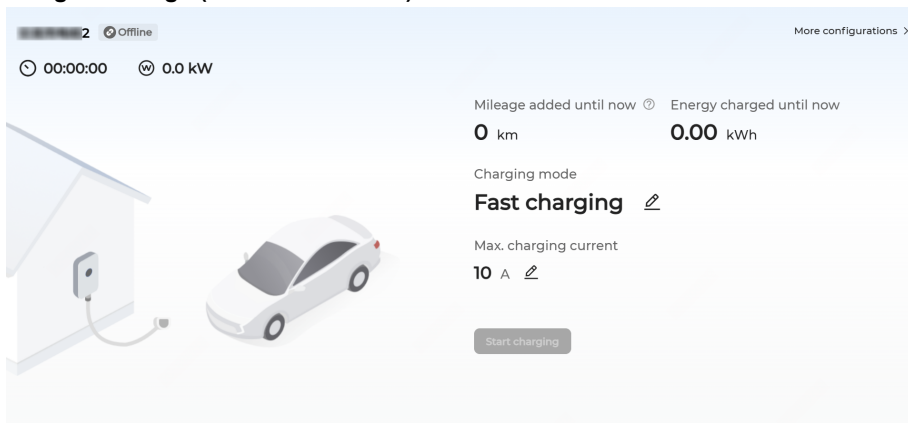

Step 1 Set the **Charging mode**.

Table 2-4 Different Charging Modes

Charging mode	Description
Fast charging	<p>Efficient charging. The EV charger can use both PV energy and grid energy and operates at the rated power, delivering the exact power required by the EV.</p> <p>Allow battery discharge ⓘ</p> <p><input checked="" type="checkbox"/></p> <p>Battery discharge cut-off SOC (%)</p> <p>10</p> <p>Range:[0 ~ 100]</p> <p>i When battery discharge is enabled, available battery energy is used first.</p>

Switch on or off the option **Allow battery discharge**.

Charging mode	Description
	<ul style="list-style-type: none"> • On (default): When the PV output is insufficient, the EV can be charged with energy discharged from the battery. In this case, you need to set Battery discharge cut-off SOC, which means that when the battery reaches its SOC lower limit, discharging stops. When battery discharge is enabled, battery energy is used first. • Off: It is not allowed to charge the EV with energy discharged from the battery.

Balanced charging. The EV charger will first use the PV green energy, and the charging priority is charger over load.

Complete the following settings:

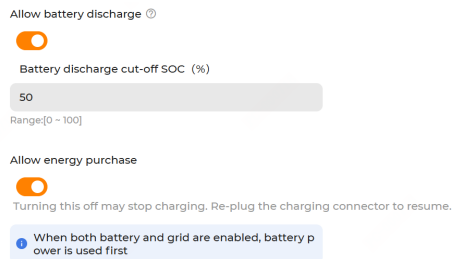

ECO & fast charging

- **Allow battery discharge:** If enabled and the PV output is insufficient, the EV can be charged with energy discharged from the battery. In this case, you need to set **Battery discharge cut-off SOC (%)**, which means that when the battery reaches its SOC lower limit, discharging stops. When battery discharge is enabled, battery energy is used first.
- **Allow energy purchase:**
 - If enabled and the PV output and battery energy are insufficient, the EV can be charged with energy purchased from the grid.
 - Turning the option off may interrupt the charging process. To resume, re-plug the charging connector.

ECO & economic charging

Economic charging. The EV charger maximizes the use of the PV green energy, and the charging priority is load over charger.

Turn on or off **Allow energy purchase**.

- If enabled and the PV output and battery energy are insufficient, the EV can be charged with energy purchased from the grid.
- Turning the option off may interrupt the charging process. To resume, re-plug the charging connector.

Step 2 Tap **Max. charging current** to update the value according to your needs, and tap **Save**.

Step 3 Tap **More configurations**.

- a. Turn on or off **Plug&Play**.
 - On: Charging begins once the charging connector is plugged into the EV.
 - Off: After the charging connector is plugged into the EV, the user needs to tap **Start charging** to charge.
- b. Specify **Mileage per kWh** based on actual requirements, which indicates how far a car can travel on 1 kWh of energy. It depends on the actual road conditions, the vehicle model, the weight of the vehicle and the load it carries, and the speed of the vehicle.
- c. Tap **Add RFID card** to set the radio frequency identification (RFID) information.
- d. Tap **Save**.

Step 4 Tap **Start charging**, and the charger status changes to **Charging**.

Tap **Stop charging**, and the charger status changes to **Charging complete**.

--End

2.3.4 Layout



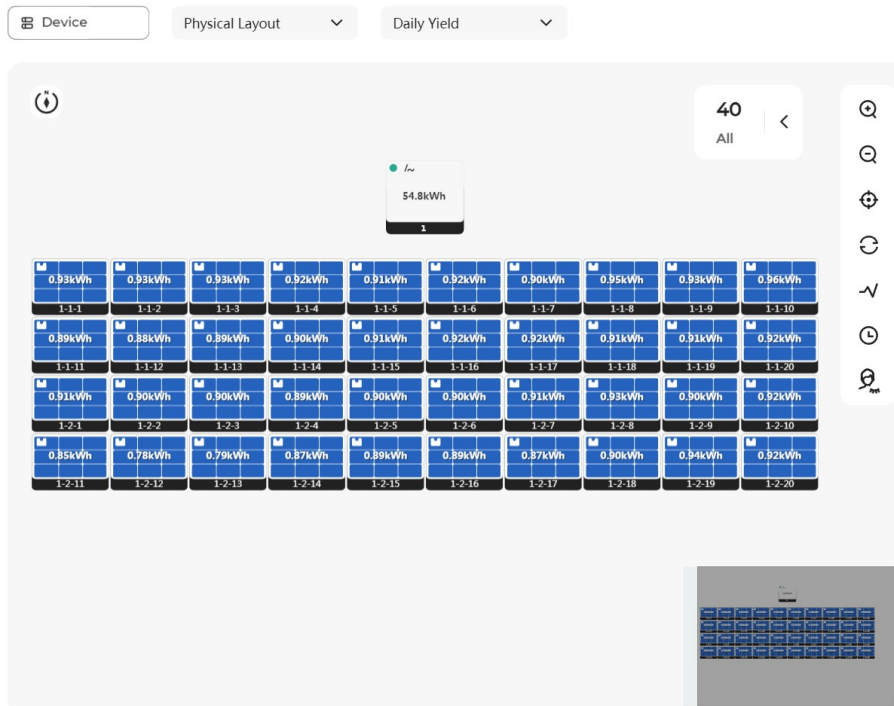

If optimizers or RSDs have been installed in the plant, you can go to **"Layout"** and check the detailed information about the optimizers or RSDs.

Click on a plant name on the "Plant" page, and you will go to **"Overview"** by default.

Choose **Layout** on the left.







- View device layout





- Click  at the top to switch between **Physical Layout** and **Logical Layout**.
- View power yield data
 - Click  at the top to switch between **Daily Yield**, **Monthly Yield**, **Annual Yield**, **Total Yield**, and **Power** and view the power generation data of modules accordingly.
- Open/Close navigator
 - If there are a large number of optimizers or RSDs, the layout page may see lags. You can click  on the right of the layout to close the navigator and thus speed up the web page. You can also click  to open the navigator again.

2.3.4.1 Check Device Status

- Check device S/N
 - Click **Device** in the upper left of the screen to check the S/N and No. of the optimizer or RSD attached to the inverter and whether it has been assigned or not.
- Check device running status
 - You can tell the status of the optimizer or RSD device based on the color of the corresponding PV module in the layout. The table below shows the relation between the PV module color and the device status.

Color	Status
	The device is operating normally
	There is a fault in the device
	There is an alarm with the device
	The device is offline

- The PV module is blue if the device is operating properly. The color shade of a module reflects its power generation efficiency. Darker blue indicates a higher power ratio and greater power generation efficiency.

Color Shade	Actual Power/PV Module Peak Power*100%
 A22C30703 1-1-1	80-100
 A22C30703 1-1-1	60-80
 A22C30703 1-1-1	40-60
 A22C30703 1-1-1	20-40
 A22C30703 1-1-1	0-20









2.3.4.2 View Device Information

逆变器

S/N **A2261559444** 

Partial Installation

Data Update Time: 27/Jan/2024 16:05:00

Yield Today(kWh)	54.80
Total Yield(kWh)	68.40
 Total DC Power(kW)	2.71
 Phase A Voltage(V)	232.8
 Phase B Voltage(V)	229.6
 Phase C Voltage(V)	230.4
 Phase A Current(A)	3.8
 Phase B Current(A)	3.8
 Phase C Current(A)	3.8
 Total Active Power(kW)	2.70

Device Name **逆变器**

Commissioning 2024-01-25 17:46:40

Device SG12RT-P2

S/N A2261559444

Manufacturer SUNGROW

Information

Inverter Settings





Optimizer Settings

Optimizer 1-2-6

S/N **A2342075167** 

Data Update Time: 27/Jan/2024 16:10:00

Tilt Angle **0**
Azimuth Angle **0**

Total Yield(kWh) **93.01**
 Input Voltage(V) **32.9**
 Output Voltage(V) **32.6**
 Input Current(A) **1.99**
 Output Current(A) **2.00**
 Output Power(W) **65**

Note: The current live data period for optimizers...

Device Name	Optimizer
Commissioning	2024-01-26 10:30:43
Module	--
S/N	A2342075167
Module Manufacturer	--

[Settings](#)

RSD 1-1-1

S/N VOPT00760101 

 Offline

Data Update Time: 2024-03-27 16:45:00

Tilt Angle	0
Azimuth Angle	0

Total Yield(MWh)	165.61
Input Voltage(V)	80.0
Output Voltage(V)	79.9
Input Current(A)	10.00
Output Current(A)	9.95
Output Power(W)	857

Device Name	RSD
Commissioning	2024-03-26 21:36:43
Module	--
S/N	VOPT00760101
Module Manufacturer	--

[Settings](#)

- Click on an inverter in the layout to view its yield data. A panel will then open on the right side. You may:
 - Choose **Information** to check the detailed information about the inverter, such as **General Information, Fault, Curve, Settings, and Remote Signaling Status**.
 - Choose **Inverter Settings** to set parameters for the inverter. See [3.3 Parameter Setting](#) for details.
 - Choose **Optimizer Settings** to set the communication frequency point for inverter. If **Auto Frequency Point Setting** is set to **Enable**, the setting will be completed by the system automatically. If **Auto Frequency Point Setting** is set to **Disable**, you can set the communication frequency point for each inverter manually. You may click **Parameter Query** to query about the current communication frequency point of the inverter.
- Click on an optimizer or RSD in the layout to view its power generation data. You can choose **Settings** to set the parameter of **PV Module Total Yield Adjustment**. You may click **Parameter Query** to query about the current setting of the inverter.

2.3.4.3 Auto Optimizer/RSD Search

This function supports fast on-site grid connection and can generate the plant's logical layout, independent of the topology from the Excel layout file.

Prerequisite: The auto optimizer/RSD search function needs to be supported in the plant inverters, and no existing physical layout has been created in the plant by importing the Excel layout file.



Supported device versions:

- Logger1000: LOGGER-SV300.001.00.P055 and higher
- WiNet-S2: WINET-SV300.001.03.P026 and higher

Step 1 Go to the **Layout** page and click **☰** > **Auto optimizer/RSD search**.

Step 2 Select one or more inverters and click **Confirm** to start the automatic search.

Auto optimizer/RSD search ✕

i During the automatic search, you cannot send commands to the inverter being tested.

	No.	Inverter name	S/N	Remarks
<input checked="" type="checkbox"/>	1	■■■■■7	A2542528435	
<input checked="" type="checkbox"/>	2	■■■■■8	A2460801460	

Cancel
Confirm

Step 3 (Optional) Click the floating window **Auto search** and go to the **Task details** dialog box for the progress.

Task details ✕

No.	Inverter name	Inverter S/N	Progress	Status	Start time	End time	Action
1	■■■■■7	A2542528435	<div style="width: 10px; height: 10px; background: linear-gradient(to right, #007bff 1%, #ccc 1%);"></div> 1%	Searching	04/Jan/2026 18:02:02	--	Stop
2	■■■■■8	A2460801460	<div style="width: 10px; height: 10px; background: linear-gradient(to right, #ccc 0%, #ccc 0%);"></div> 0%	Waiting	--	--	Stop

Step 4 Upon the search completion, view the logical layout of the plant.



Click on the upper left corner of the **Layout** screen to switch between the physical layout and the logical layout.

--End

2.3.4.4 Inverter Settings

- Set the frequency point for the inverter

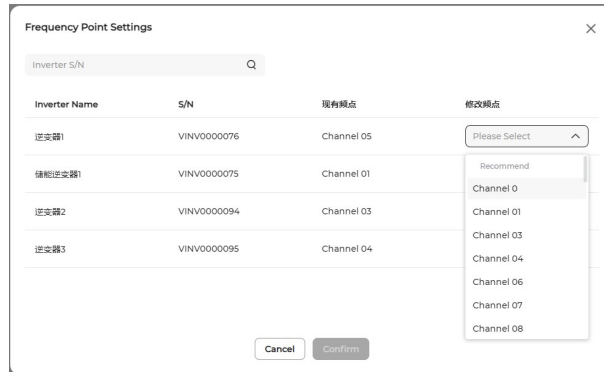

1. Choose > **Frequency Point Settings** at the top of the “Layout” page.
2. Click to the right of the inverter, select a new frequency point, and click **Confirm**.



Prioritize the recommended frequency points when setting.
The frequency points set for inverters in the same plant cannot be the same.

- Change inverter name or number

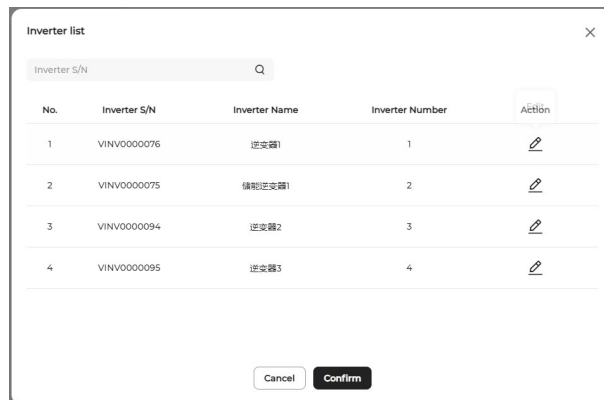

1. Choose > **Edit Inverter** at the top of the “Layout” page.
2. Click to the right of the inverter to change the **Inverter Name** or **Inverter Number**.
3. Click to save the settings.



The numbers set for inverters in the same plant cannot be the same.

- Set layout viewing permissions

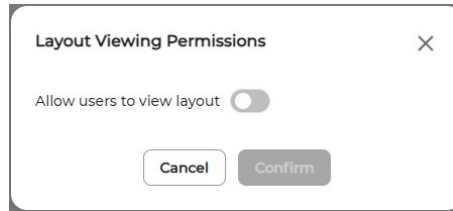

1. Choose **☰** > **Layout Viewing Permissions** at the top of the “Layout” page.
2. If the button **Allow users to view layout** is turned on, users can view the layout of the plant using an Owner account.
If the button **Allow users to view layout** is turned off, users cannot view the layout using an Owner account.



The Owner users may ask the upper-level retailer/installer to grant them layout viewing permission if needed.

2.3.4.5 Export Layout

To export the current layout on the canvas, click **☰** and choose **Export Layout**. The export progress will be displayed on the page.

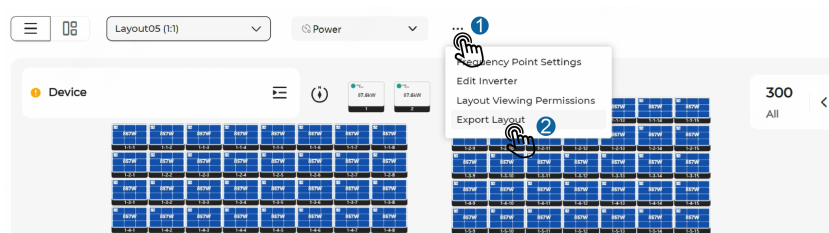

You can select another layout from the layout drop-down list to export that layout.

NOTICE

You cannot export a layout under any of the following conditions:

- The layout is empty.
- There are optimizers/RSDs not associated with modules.
- There are optimizers/RSDs with an inverter string number of 200 in their optimizer/RSD numbers.

2.3.5 Plant Device

Click a plant name on the Plant page, and you will go to **Overview** by default. Then, choose **Device** on the left to go to the device list. Here you can view the general device information and the fault alarm information. The page is shown below:

设备名称	设备ID	设备S/N	设备状态	操作
能量管理系统	E46300CP	S3024085	正常	编辑 删除
本地储能系统	LC200-S1200CS	S240296084	正常	编辑 删除
储能柜风扇	SC25CX	--	正常	编辑 删除
电池管理系统	LC200-CAU200CP	--	正常	编辑 删除
电扇	DT1013N2	--	正常	编辑 删除
紧急通风系统	FIRE_FAN	--	正常	编辑 删除
可燃气体检测器	Gas	--	正常	编辑 删除
复合气体检测器	COMPOSITE_DETECTOR	--	正常	编辑 删除

Figure 2-3 Plant Device List

Operations

• Search for Device

You can search for a device by type, status, name, or S/N using the drop-down box and search box at the top of the page. Then, click **Search**. Devices that meet the search criteria will then be shown on the page.

• View Device Information

Click the device name to go to the details page. Here you can view the detailed information about the device, such as the general information, fault alarm, and power curve.



- When the Device type is set to Local controller, PCS, Battery system controller, Battery cluster management unit, Composite detector, HVAC, Combustible gas detector, and Emergency ventilation system, more device information can be displayed. See [2.3.5.1 View C&I ESS Information](#) for details.
- When the Device type is set to C&I energy storage battery cabinet, more device information can be displayed. See [2.3.5.2 View C&I Energy Storage Battery Cabinet Information](#) for details.

• Add Device

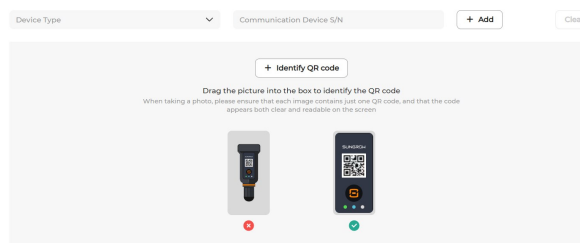



1. Click **Add device** in the upper right corner of the page.
2. Add a communication device. Two methods are available to add a communication device:
 - Add manually: Select the device model, enter the S/N of the communication device, and click **Add**.

- Scan a QR code: Click **Identify QR code**. Upload a picture of the device's QR code, or drag and drop the picture to the box for QR code identification.

3. Click **Confirm** to finish adding.

- Switch Between List View and Card View

- Click  in the upper right corner to show the devices in a list view.
- Click  in the upper right corner to show the devices in a card view.

- Change Device Name

Click , enter a new device name, and click **Confirm**.

- Replace Device

In case any device in the plant has been damaged or replaced, please proceed as follows to replace the device in the iSolarCloud system.

• Before replacing the device, please ensure that:

1. The new device's total yield has been cleared;
2. The device has been replaced in the plant.

Please replace carefully. A replacement error will cause data loss.

Old Device

Device Name

Total Yield
68.7kWh

Device Type
Inverter

S/N
A220001154

Manufacturer
SUNGROW

New Device

+

Add New Device for Replacement
[Add Manually >](#)

Add Compensatory Yield to New Device

[Start Replacement](#)

1. Click  to go to **Device replacement**.

2. Check if the information about the device to be replaced is correct. If so, click  to go to **Add device**.

- Enter the device name or S/N, and click **Search**. Then, select the new device, and click **Confirm**.
- Click **Add manually**, enter the S/N of the new device, and click **Confirm**.

3. Check if the information about the new device is correct. If so, click **Start replacement**.



When replacing an inverter, you can select **Add compensatory yield to new device** to add the total yield of the old device to that of the new device as compensatory yield.

- Delete Device

Choose **...** > **Delete** in the **Action** column to delete the device. Then, all data on the device, such as those related to the inverter, will be deleted.

- Rearrange Items in Device List

Device Name	Device Model	Device S/N	Device Status	Action
	SCDRT-P2	A3-11111111	Normal	
	WiNet-S2	B3-11111111	Normal	

Click or choose ***** > Pin to top** in the **Action** column to pin the device to the top of the list. If multiple devices are pinned, the newly pinned will always top the previously pinned.

2.3.5.1 View C&I ESS Information

Step 1 Click a device name to enter the **device details** page.

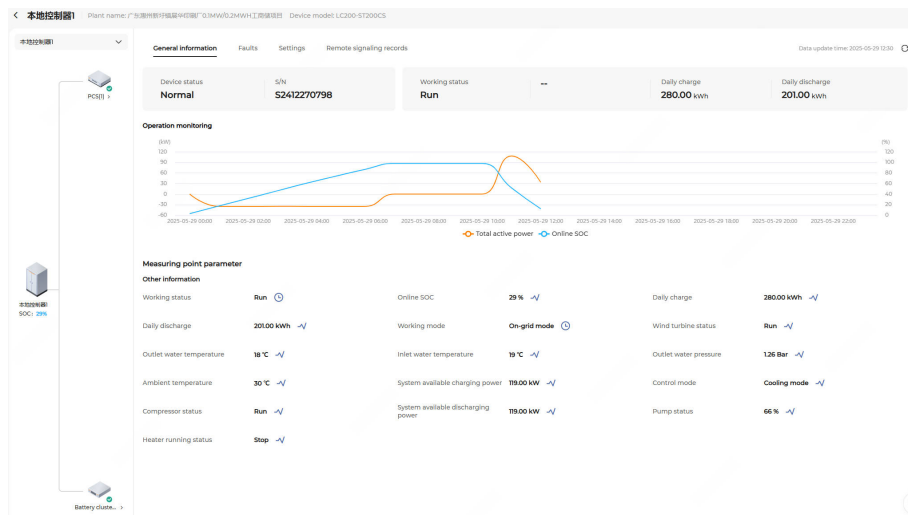

Step 2 View device information.

Device Type	Indicators
Local controller	Displays device status, device S/N, energy storage active power, SOC, ESS daily charge, ESS daily discharge, total active power curve, and daily SOC curve.
PCS	Displays device status, device S/N, total active power, total reactive power, daily charge, daily discharge, and daily active power curve.
Battery system controller	Displays device status and device S/N.
Battery cluster management unit	Displays device status, device S/N, highest cell voltage, lowest cell voltage, highest cell temperature, lowest cell temperature, as well as daily curves of the highest and lowest cell voltages and temperatures.

Device Type	Indicators
	<ul style="list-style-type: none"> • By switching between Voltage and Temperature in the upper left corner of the Cell monitoring page, you can view the voltage and temperature values of the Racks. • You can click a Pack to view all cell information under the Pack.
	
<div style="border: 1px solid gray; padding: 5px;"> <p>Each column of Packs on the page are arranged in ascending order from top to bottom. Please refer to the actual Pack data shown on the interface.</p> </div>	
Composite detector	Displays device status and device S/N.
HVAC	Displays device status and device S/N.
Combustible gas detector	Displays device status and device S/N.
Emergency ventilation system	Displays device status and device S/N.



The displayed indicators vary by device type. Please refer to the actual interface.

Step 3 View device faults:

Click the **Faults** tab. For detailed instructions, see [3.2 Fault List](#).

Step 4 Set parameters.

- a. Click the **Settings** tab.
- b. For detailed instructions, see [3.3 Parameter Setting](#).

--End

2.3.5.2 View C&I Energy Storage Battery Cabinet Information

Step 1 Click **Device** for a C&I ESS plant. The page displays all cloud-connected devices in the C&I ESS plant.

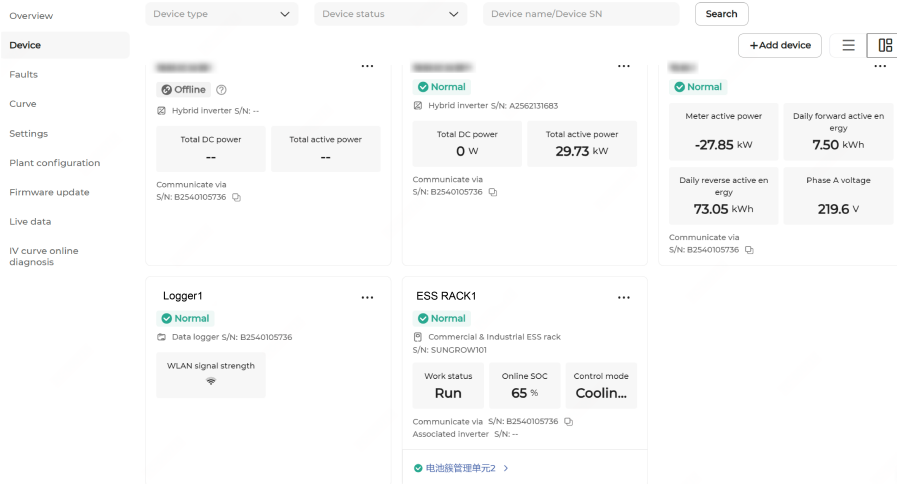

Step 2 You can view the name, status, and S/N of each C&I energy storage battery cabinet. Click a C&I energy storage battery cabinet to view its details.

Step 3 View general information: On the details page of the C&I energy storage battery cabinet, you can view the measuring point data and device information on the **General information** tab.

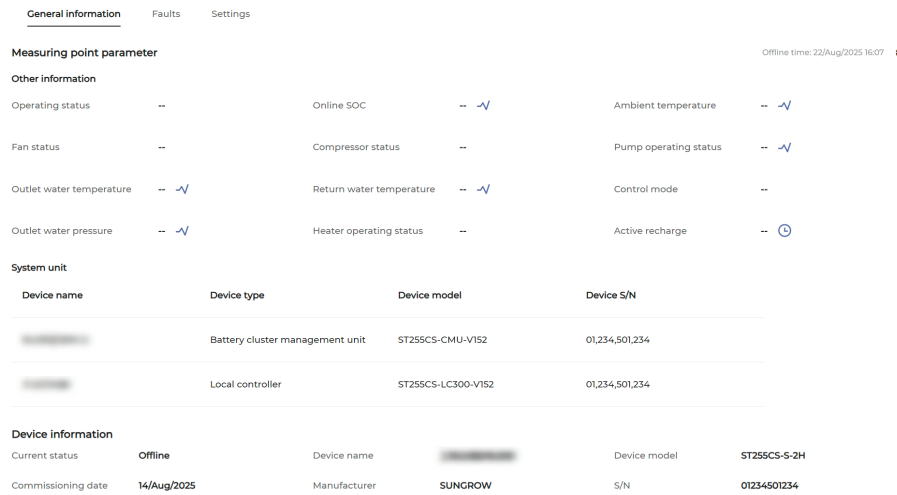

Step 4 View device faults: Click the **Fault** tab to view pending and resolved faults of the device.

Step 5 Settings: Click the **Settings** tab to configure common settings for the device. See [3.3 Parameter Setting](#) for details.

The **Settings** tab is not available for battery cluster management units.

--End

2.3.5.3 Configure Third-Party Device Parameters

iHomeManager, at the center of the residential energy management system, allows more smart electric devices to be connected to the PV & ESS system, helps you more flexibly adjust the devices' working time and mode, and effectively dispatches energy, to improve PV self-consumption rate, reducing electricity costs, and making the residential power system smarter.

When a third-party device is connected, click the device name to enter the **General information** page for details, and switch to the **Settings** tab to configure the parameters.

2.3.5.3.1 Shelly Smart Plugs

Step 1 Click the name of the Shelly smart plug to go to the **Settings** page and switch on the **AI suggestion** option.

Step 2 In the pop-up, set **Rated power** and **Single-use duration**, select the expected time period to receive AI recommendations, and click **Confirm**.

Step 3 Choose the recurrence date and drag the time bar left or right to adjust the start and end time for AI recommendations.

Step 4 Click **Apply settings** to save and enable AI suggestions.

--End



After enabling **AI suggestion**, when in AI mode, the system will generate suggestions on the load operation period. The **Load operation period** curve is accessible from the **AI mode** on the **Overview** page.

2.3.5.3.2 Shelly Relays

Step 1 Click the name of the Shelly relay to go to the **Settings** page and choose **Mode**.

- Switch mode is used to control the connection and disconnection of two circuits independently and intelligently.
 - a. Choose a circuit and enable/disable **AI suggestion**.
 - b. After enabling **AI suggestion**, in the pop-up, set **Rated power** and **Single-use duration**, select the expected time period to receive AI recommendations, and click **Confirm**.

- c. Choose the recurrence date and drag the time bar left or right to adjust the start and end time for AI recommendations.

- d. Repeat the steps above to set up for another circuit.
 - e. Click **Apply settings** to save and enable AI suggestions.
- Cover mode is used to control the roller shutter doors. Click the **Instant control** button, and in the pop-up, click , , and  (up/down/pause) to control the door movement.

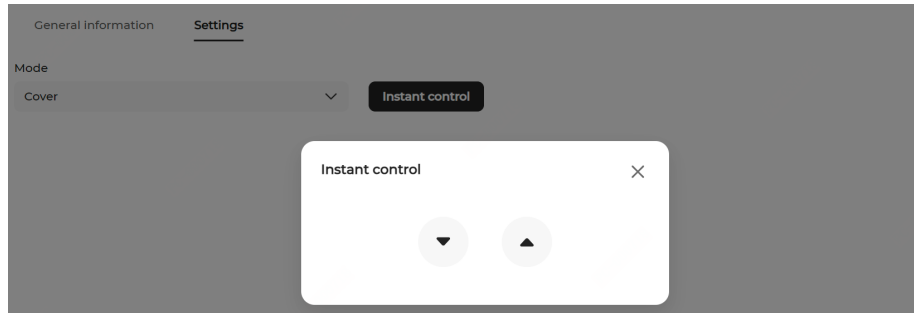

--End

After enabling **AI suggestion**, when in the switch mode, the system will generate suggestions on the load operation period. The **Load operation period** curve is accessible from the **AI mode** on the **Overview** page.

2.3.5.3.3 EEBUS Protocol-Based Heat Pump

The setup below takes as an example a Vaillant aroTHERM heat pump.

Step 1 Click the name of the EEBUS heat pump to go to the **Settings** page and fill in the **Target temperature** within the range of 35 to 70°C.

Step 2 Select the working mode.

- OFF (default): The pump is forced to shut down.
- ON: The system automatically adjusts the temperature within the defined range, irrespective of the time periods.
- AUTO: According to the defined weekly time plan, the system only operates within the time periods and automatically adjusts the temperature to the target; otherwise, the system is forced to shut down outside the defined periods.

Step 3 Enable/disable **Allow iHomeManager control**.

- When the option is enabled, under the self-consumption or AI mode, the system will automatically control the heat pump within the defined time period, and prioritize the use of the PV green energy to adjust the temperature.
- When the option is disabled (default), the system will restore the heat pump working mode to the previous mode.

After enabling the option, in the pop-up, set **Rated power**, select the expected time period to receive AI recommendations, and click **Confirm**.

Step 4 Choose the recurrence date and drag the time bar left or right to adjust the start and end time for AI recommendations.

General information **Settings**

* Target temperature (°C)

50

Value range: 35 - 70

Allow iHomeManager control

Operating mode

ON

Available periods

Repeated: Sun Mon Tue Wed Thur Fri Sat Clear

00:00 01:00 02:00 03:00 04:00 05:00 06:00 07:00 08:00 09:00 10:00 11:00 12:00 13:00 14:00 15:00 16:00 17:00 18:00 19:00 20:00 21:00 22:00 23:00 24:00

06:00-20:00

+ Add recommended period

Step 5 Click **Apply settings** to complete.

--End

2.3.6 Fault

Click on a plant name on the “Plant” page to go to “**Overview**”, then choose **Fault** on the left. You will see a list of faults in pending state. Here you can view the device alarms.

See [3.2 Fault List](#) for details.

2.3.7 Data Analysis

Click on a plant name on the **Plant** page to go to the **Overview** tab by default. Click **Live data** in the left sidebar for a multi-dimensional data analysis report.

2.3.7.1 Device Curve

Step 1 Click the **Device curve** tab.

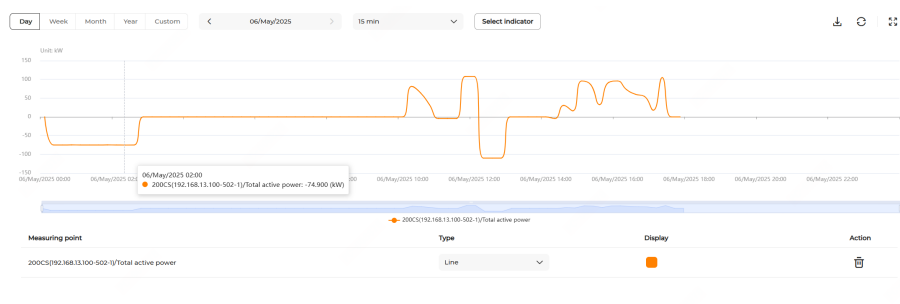

Step 2 Select a time period



- Click “Day”, “Week”, “Month”, “Year”, or “Custom” to view curves generated based on data from different time periods.
- Set the time interval.

Step 3 Select indicators

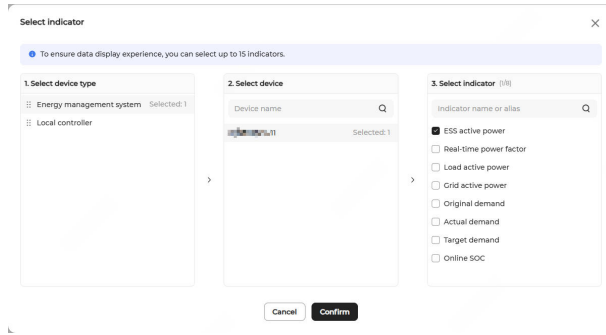
Click **Select indicator**. In the pop-up window, select the device type, device, and indicators, then click **Confirm**. > >



Step 4 Go/Exit full screen

- Click  to view curves in full screen.
- Click  to exit the full-screen mode.

Step 5 Refresh data

Click  to refresh the current data curves.

Step 6 Export data

Click  to export the data of the curves that are currently shown.

Step 7 Delete indicator

Click  in the **Action** column to delete an indicator. The corresponding data will no longer be displayed.

--End

2.3.7.2 Revenue Deviation Curve

Step 1 Click the **Revenue deviation curve** tab.

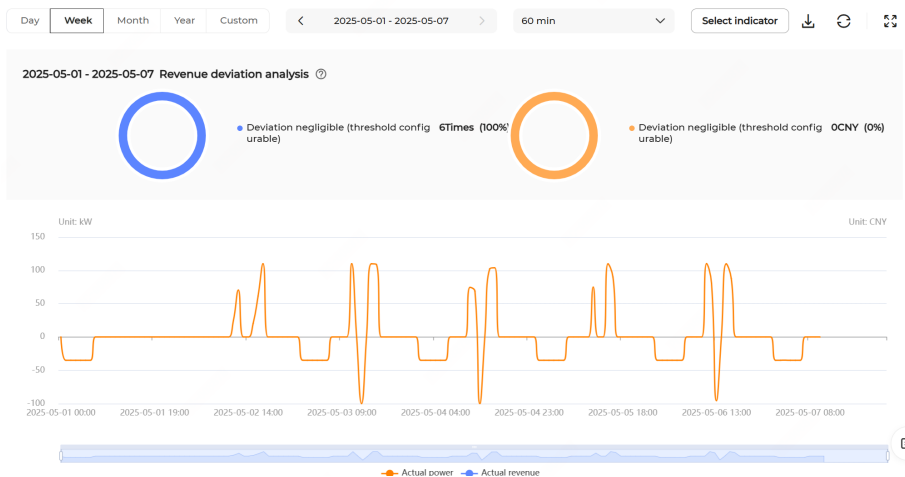

Step 2 Select a time period

- Click “Day”, “Week”, “Month”, “Year”, “Lifetime”, or “Custom” to view curves generated based on data from different time periods.
- Set the time interval.

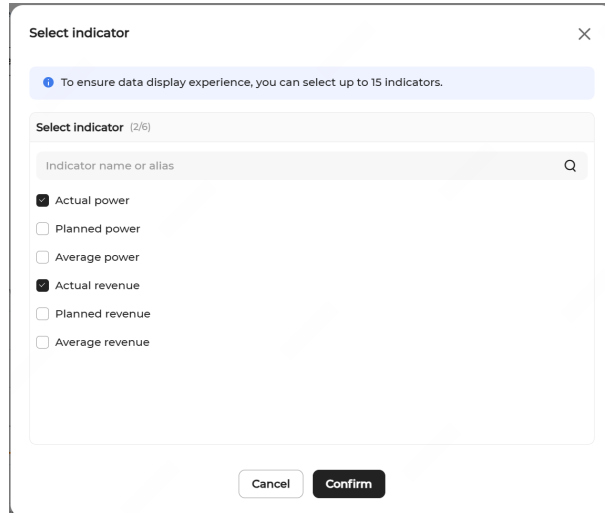

Step 3 Select indicators

Click **Select indicator**. In the pop-up window, select indicators, then click **Confirm**.



To ensure optimal data display, you can select up to 15 indicators.

Step 4 Go/Exit full screen

- Click  to view curves in full screen.
- Click  to exit the full-screen mode.

Step 5 Refresh data

Click  to refresh the current data curves.

Step 6 Export data

Click  to export the data of the curves that are currently shown.

Step 7 Delete an indicator

Click  in the **Action** column to delete an indicator. The corresponding data will no longer be displayed.

--End

2.3.7.3 Demand Analysis

The Demand analysis displays the maximum demand value collected by the meter in the current month and the occurrence time. At the end of the month, the system will display the grid power curve and ESS charging/discharging curves of the day with the maximum demand.



This function is unavailable if no meter is installed in the plant.



Step 1 Click to select an energy management system.

Step 2 Click the time selector to choose the target month. You can then view the demand values for the month and the monthly demand heatmap.

Step 3 Click a curve or demand value in the heatmap to view the **Peak demand curve**.

--End

2.3.7.4 Power Following

This function enables you to view the active power and online SOC curves of the ESS in the current plant.



It is only supported for C&I ESS plants.

Step 1 Click the **Power following** tab.

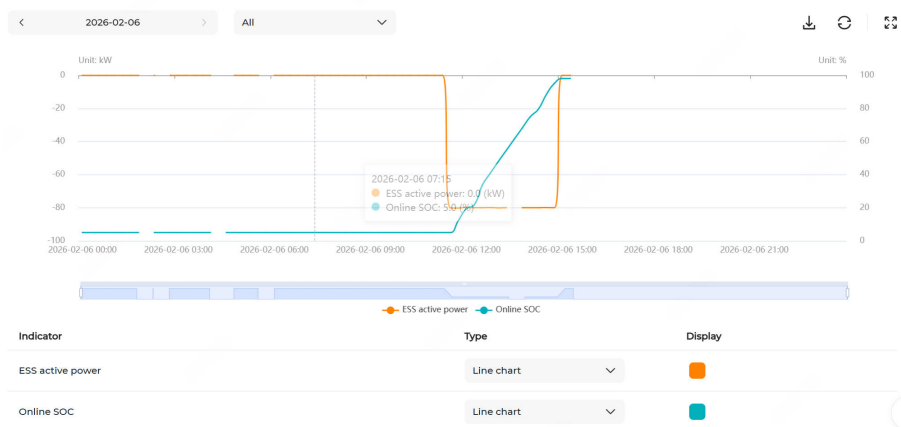

Step 2 Select the time and device.

Step 3 Click the icons or to enter or exit the full screen when viewing the data.

Step 4 Click the icon to refresh the current data curves.

Step 5 Export data. Click the icon to export the data filtered by the current criteria.

--End

2.3.7.5 Load Following

This function enables you to view the active power curves of the ESS, loads, and the grid in the current plant.

i It is only supported for C&I ESS plants.

Step 1 Click the **Load following** tab.

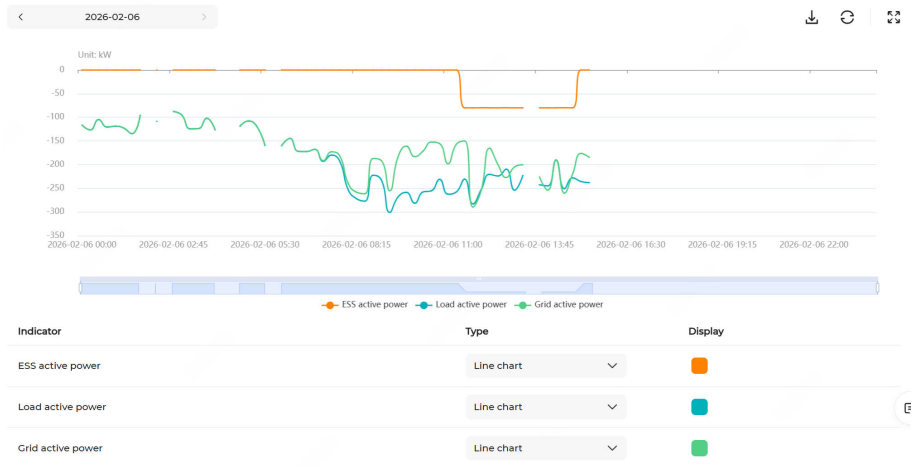

Step 2 Select the time.

Step 3 Click the icons or to enter or exit the full screen when viewing the data.

Step 4 Click the icon to refresh the current data curves.

Step 5 Export data. Click the icon to export the data filtered by the current criteria.

--End

2.3.7.6 Charging/Discharging Statistics



This page is designed to summarize and analyze the ESS charging and discharging statistics in the defined time period. You can filter by different device models and export the data.

i It is only supported for C&I ESS plants.

Step 1 Click the **Charging/discharging statistics** tab.

Device name	Charging/discharging type	Start time	End time	Start SOC (%)	End SOC (%)	Charging/discharging energy (kWh)	Charging/discharging duration (h)
	Charging	2026-02-06 11:20:00	2026-02-06 14:55:00	5	98.1	268	3.58

Step 2 Select a time period and device model.

Step 3 Click the icons  or  to enter or exit the full screen when viewing the data.

Step 4 Export data. Click the icon  to export the data filtered by the current criteria.

--End

2.3.8 Parameter Settings

Click a plant name on the **Plant** page for details, and the **Overview** tab is displayed by default. Choose **Settings** in the left navigation bar to configure **Quick setting**, **Device parameters**, **General information**, and **Tariff**.

2.3.8.1 Quick Setting

This function enables you to configure key parameters of the plant, including energy management parameters, battery, grid connection point, and others.



Functions available may vary by plant and account types. Refer to the information actually shown on the page.

The screenshot shows the 'Quick setting' page. At the top, there are navigation tabs: 'Quick setting', 'Device parameters', 'General information', and 'Tariff'. Below this, the 'Energy management parameters' section contains a card for 'Energy management mode' with a 'View' button. The 'Battery settings' section contains four cards: 'Fast charge' (Open), 'Fast Discharge' (Open), 'Battery augmentation' (Enable), and 'Winter battery heating' (Enable). The 'Others' section contains a card for 'Smart Load'.

2.3.8.1.1 Energy Management Parameters

Energy management mode manages and configures the plant operation strategy. The card displays the current energy management mode. You can click the button **View** to see or modify the mode settings.

Energy management parameters

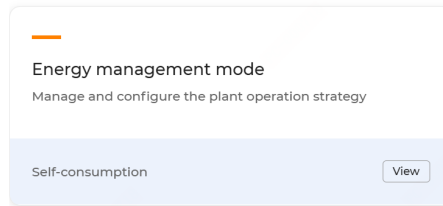

To configure Data Logger energy management, refer to [3.3.2.1.2 Energy Management](#), and to configure iHomeManager energy management, refer to [3.3.2.2.1 Energy Management](#).

2.3.8.1.1.1 Energy Management Parameters for Hybrid Inverters

By leveraging a hybrid inverter to manage energy dispatch in the system, you can select the inverter' operating mode as needed to manage and utilize electricity effectively.

The following operating modes are available:

Mode	Description
Self-consumption	The Self-consumption mode prioritizes the use of PV green energy, only drawing energy from the grid when the PV supply is insufficient.
Forced mode	It is mainly used in battery O&M to control the battery and make it operate in compliance with the preset charging/discharging mode and power.
Microgrid mode	Power is generate using an external generator to reduce grid dependence.



When the hybrid inverter operates in the virtual power plant (VPP) mode or under external energy dispatch, the plant is controlled by a third party, and mode switching is not allowed.

2.3.8.1.1.1.1 Self-Consumption

Prerequisite

Function logic:

- Under sufficient sunlight, the power supply priority is as follows:
PV energy first serves household loads and then charges the battery, with the excess energy fed to the grid.
- Under insufficient sunlight, the power supply priority is as follows:
PV energy first serves household loads, and when PV output falls short, the battery discharges for compensation. If the power is still not enough, energy is purchased from the grid.

Energy management mode ⓘ

- Self-consumption** ⓘ
Maximizes the use of green energy to supply house load and only use grid energy when green energy is insufficient
- Forced mode** ⓘ
Primarily used for battery maintenance scenarios, featuring manual charge/discharge control.
- Microgrid mode** ⓘ Running
Generate power using an external generator to reduce grid dependence

Time period
Every day ▼

Legend: ■ Allow discharging ⓘ ■ Forced charging ⓘ

Timeline (00:00 to 24:00):
 - Allow discharging: 00:00-06:30
 - Forced charging: 10:00-14:00 (Target SOC: 100%)

Save

Step 1 Navigate to the **Energy management** page and select the **Self-consumption** mode.

Step 2 Choose either **Every day** or **Working days & Non-working days** for the charging and discharging time periods to be effective.

Step 3 Click a time period in the **Allow discharging** time bar to add a new discharging period. Then, drag and drop the left or right border of the bar to adjust the duration.

Step 4 Click a time period in the **Forced charge** time bar to add a new charging period. Then, drag and drop the left or right border of the bar to adjust the duration. Click a time period that has been added, and set a charging target in **Target SOC (%)**.



- Allow discharging: Within the specific time period, allow the battery to discharge to supply the loads. The default time period is 24h (0-24h).
- Forced charging: In the specified time period, charge the battery at its maximum allowable power until reaching the preset target SOC.

Step 5 Click **Save**.

--End

2.3.8.1.1.1.2 Forced Mode

Step 1 Navigate to the **Energy Management** page and select the **Forced mode**.

Step 2 Choose an option in **Charging/discharging command**.

- Charge: Force the battery to charge at the preset charging power.
- Discharge: Force the battery to discharge at the preset discharging power.
- Stop: Manually stop battery charging or discharging.

Step 3 If **Charge** or **Discharge** is selected, set the target value in **Charging/discharging power**.

Step 4 Click **Save**.

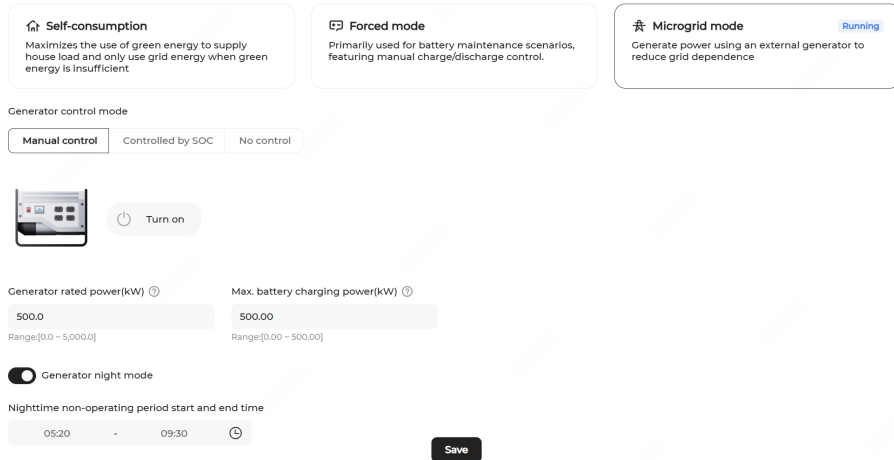

--End

2.3.8.1.1.1.3 Microgrid Mode



Step 1 Navigate to the **Energy management** page and select the **Microgrid mode**.

Step 2 Set up the **Generator control mode**. Options include:

Generator Control Mode	Procedures
Manual control	<ol style="list-style-type: none"> a. Click Enable to start the generator. b. Specify the Generator rated power. <div data-bbox="539 950 1187 1034" style="border: 1px solid gray; padding: 5px; margin-top: 5px;"> <p> Enter a value based on the actual situation. A wrong setup may compromise normal system operation.</p> </div> c. Define the Max. battery charging power. <div data-bbox="539 1099 1187 1236" style="border: 1px solid gray; padding: 5px; margin-top: 5px;"> <p> Set this parameter according to the specifications of the household switch and cables, thereby avoiding tripping or circuit damage caused by excessive AC charging current of the battery.</p> </div> d. Turn on or off the option Generator night mode. If it is enabled, define Nighttime non-operating period start and end time.

Controlled by
SOC

- a. Configure the following parameters.
 - **Battery SOC threshold for generator startup:** When the battery SOC reaches the lower limit, the generator is started to supply power to loads and charge batteries.
 - **Battery SOC threshold for generator shutdown:** When the battery SOC exceeds the upper limit, the diesel generator will be shut down.
 - **Generator rated power:** Enter a value based on the actual situation. A wrong setup may compromise normal system operation.

Generator Control Mode	Procedures
No control	Control the generator on-site without the App.

- **Max. battery charging power:** Set this parameter according to the specifications of the household switch and cables, thereby avoiding tripping or circuit damage caused by excessive AC charging current of the battery.
- b. Turn on or off the option **Generator night mode**. If it is enabled, define **Nighttime non-operating period start and end time**.

Step 3 Click **Save**.

--End

2.3.8.1.2 Battery Settings

When at least one battery is equipped in the plant, you can manage and configure it in **Battery settings**, where key functions include fast charging/discharging, quick backup, battery augmentation, and winter battery heating.

Tap **View** or **Turn on** in a specific tile for more settings.

Battery settings

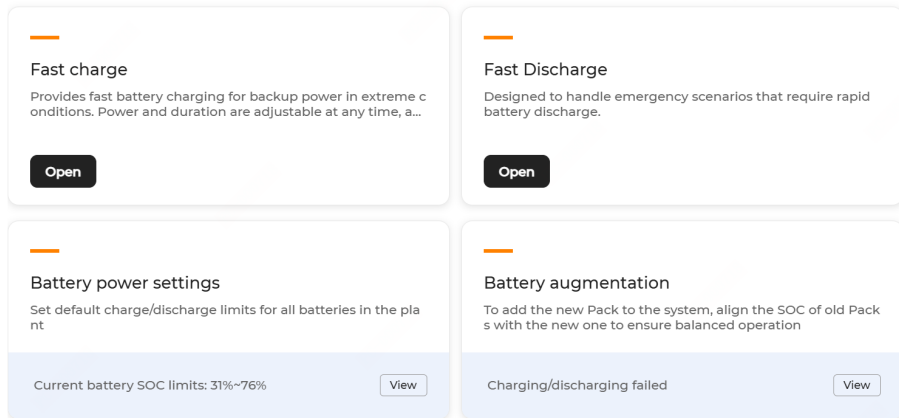

2.3.8.1.2.1 Quick Charge

Enabling **Quick charge** allows rapid battery charging during extreme weather conditions, providing backup power. You can set the power and duration, and change or disable it anytime.

Step 1 Click **Quick charge**.

Quick charge ×

Enable quick backup to rapidly charge the battery during extreme weather or other emergencies. You can set the power and duration, and change or disable it anytime.

Charging power

- Maximum power
 50% of max. power
 25% of max. power

Power: 10.6 kW

Charging duration

- 2 hours
 1 hour
 0.5 hours

Step 2 In the pop-up screen, define **Charging power** and **Charging duration**.

Step 3 Click **Enable**.

--End

2.3.8.1.2.2 Fast Discharging

Under emergency, you can enable the fast discharging function to discharge the battery.



Fast charging and fast discharging are mutually exclusive.

Step 1 Set the option **Quick discharge** to **Enable**.

Quick discharge ×

Designed to handle emergency scenarios that require rapid battery discharge.

Discharging power

Maximum power
 50% of max. power
 25% of max. power

Power: 12.0 kW

Discharging duration

0 0.5h 1h 1.5h 2h 2.5h 3h 3.5h 4h

Try scheduled discharging [Settings](#) >

Step 2 Select **Discharging power** and **Discharging duration**.

Step 3 Click **One-click enable**.

Step 4 To let the system discharge at the specific time frame, follow the procedures below:

- a. Click **Set** on the right of the field **Try scheduled discharging** to enter the **Scheduled discharging** page.
- b. Switch on the option **Scheduled enable**.
- c. Choose either **Every day** or **Working days & Non-working days** for the charging and discharging time periods to be effective.
- d. Define the **Start time**.
- e. Select **Discharging power** and **Discharging duration**.
- f. Click **Save**.

--End

2.3.8.1.2.3 System Power Backup

To satisfy the energy demand under off-grid scenarios, you can reserve the battery energy via either smart backup or manual backup.

Click the button **View** in the **System backup** tile for details. In the option **Backup mode**, choose either **Smart backup** or **Manual backup**.

- **Smart backup:** According to the local grid outage schedule, the system analyzes the load demand in real time and guarantees an uninterrupted power supply to ensure sufficient power for the load during an outage.
- **Manual backup:** To reserve backup power for off-grid operations, you need to define the lower discharge limit for the inverter running in grid connection.

2.3.8.1.2.3.1 Smart Backup

In response to the dynamic and planned load shedding of the grid in South Africa, the system incorporates the local shedding plans and generates the backup schedules to ensure that the energy storage system (ESS) has sufficient power for the load during an outage.

Prerequisite

The function smart backup is available only in South Africa (the international server) to respond to a rationed power supply or rolling blackout.

Step 1 Choose **Smart backup** as the **System power backup** method.

Step 2 Define the location to obtain the outage schedule and backup plan.

Step 3 Click **Enable**. Once it takes effect, the system will reserve the battery energy according to the backup plan.

System power backup

01 Please select a system backup mode



Smart backup

Running

Smart backup analyzes local grid outage schedules and load demand in real time to ensure uninterrupted power supply and sufficient stored energy during power outages.



Manual backup

To reserve backup power for off-grid use, set the minimum discharge limit while the inverter is grid-connected.

Eskom

Level 5

02 Please select your region to get a more accurate outage schedule and backup plan

Mpumalanga / Lekwa / Elandslaagte (14)

Today Mon, 16/Mar Total 7.5 h



05:00 - 07:30

Backup SOC: 90%

13:00 - 15:30

Backup SOC: 90%

21:00 - 23:30

Backup SOC: 90%

Tomorrow Tue, 17/Mar Total 7.5 h



03:00 - 05:30

Backup SOC: 90%

11:00 - 13:30

Backup SOC: 90%

19:00 - 21:30

Backup SOC: 90%

Historical outage schedule Ongoing outage schedule Upcoming outage schedule

--End

2.3.8.1.2.4 Battery Power Settings

This function allows you to configure the default upper limit for charging and lower limit for discharging for all batteries of the plant.



It is available in the international server and European server.

Step 1 Click the **View** button to display **Battery power settings**.

Step 2 In the pop-up window, set up **Discharge cut-off** and **Charge cut-off**.



It is advised to define the discharge cut-off SOC higher than 10% to prevent the battery from harm caused by over-discharge.

Step 3 Click **Save**.

--End

2.3.8.1.2.5 Battery Augmentation



To ensure proper operation of the newly added battery, set the SOC of the newly added Pack to match the current device's battery SOC.

Step 1 Click the **Enable** button in **Battery augmentation** and choose **More settings** in the pop-up.

More configurations ×

i To ensure proper battery operation, set the SOC of the current device's battery to match the SOC of the newly added Pack.

* New Pack SOC(%)

Enter here Retrieve

Charging/discharging started

Execute now ▼

Cancel Confirm

Step 2 Enter the **New Pack SOC (%)**. Click **Retrieve** and enter **New Pack S/N** to retrieve this value.

Step 3 Select an execution option in **Charging/discharging started**.

Step 4 Click **Confirm** and choose **Start charging/discharging**.

--End

2.3.8.1.2.6 Winter Battery Heating

Battery cannot be charged when its temperature is below 0°C. After enabling **Winter battery heating**, the system will use PV power to heat the battery during the configured time period until it reaches a normal temperature and then stop automatically.

Step 1 Enable **Winter battery heating**.

Quick setting Device parameters

< Back

Winter battery heating

i Battery cannot be charged when its temperature is below 0°C. After enabling Winter battery heating, the system will use PV power to heat the battery during the configured time period until it reaches a normal temperature and then stop automatically.

Battery heating schedule 1

Repeated Tue x ▼

Battery heating time 16:00-18:00

00:00 01:00 02:00 03:00 04:00 05:00 06:00 07:00 08:00 09:00 10:00 11:00 12:00 13:00 14:00 15:00 16:00 17:00 18:00 19:00 20:00 21:00 22:00 23:00 24:00

+ Add schedule

Enable

Step 2 Select the repeat time for battery heating (multiple selections supported).

Step 3 Set the time period for battery heating. Click the corresponding time range to add a new time period (up to 4 time periods can be set). Drag the time window left or right to adjust its duration.

Step 4 To add a new battery heating schedule, click **Add schedule** and continue setting the heating schedule.

Step 5 Click **Enable**.

--End

2.3.8.1.3 Grid Power Limit



In the card **Grid power limit**, click **Complete them now**. **Grid power limit** and **Time-of-use feed-in power limitation** are included. After the settings are done, system input and output will be limited based on grid or system requirements.



2.3.8.1.3.1 Grid Power Limit

With **Grid power limit**, the feed-in power and power for energy purchase are limited accordingly.

Step 1 Click **Grid power limit**.

Feed-in power limitation 

Feed-in control method  * Feed-in power limit ratio 

Total active power control  Enter here  %

Range:[0.0 ~ 100.0]

Power limit for energy purchase 

* Power limit for energy purchase

3.00 kW

Range:[0.01 ~ 500.00]

Step 2 Configure the feed-in power limitation and other parameters.

Parameter	Description
Feed-in power limitation	To limit the total feed-in power, enable Feed-in power limitation and disable Per-phase feed-in limitation (if there is this option).
Feed-in control method	<p>Set one of the following feed-in power control methods and the corresponding values according to the requirements of the local grid company to prevent the system from feeding back more power than the settings.</p> <ul style="list-style-type: none"> Total active power control Per-phase active power control <div style="border: 1px solid gray; padding: 5px; margin-top: 10px;"> <p> Per-phase active power control is available only when the inverter supports power feed-in per phase.</p> </div>

Parameter	Description
Feed-in power limit value/ratio, Phase A/B/C feed-in power limit value/ratio	<ul style="list-style-type: none"> • Feed-in power limit value/ratio: It is available when the Feed-in control method is defined as Total active power control. Enter a value or ratio based on the actually allowed feed-in power. • Phase A/B/C feed-in power limit value/ratio: It is available when the Feed-in control method is defined as Per-phase active power control. Enter a value or ratio based on the actually allowed feed-in power for phases A, B, and C. <div style="border: 1px solid gray; padding: 5px; margin-top: 10px;">  You can switch the unit between kW and % to define the power limit value or ratio. </div>

Step 3 Configure **Power limit for energy purchase**.

Set an upper limit for energy purchased from the grid. This value is subject to the maximum current of the household circuit breaker and allowable energy purchasing power of the grid company.

Step 4 Click **Save**.

--End

2.3.8.1.3.2 Time-of-Use Feed-in Power Limitation

Define separate time plans for different dates (for example, weekdays and weekends) and specify the power limit duration for each plan. This accurately limits the feed-in power of different periods.

Prerequisite

Ensure that the plant is located in Brazil (in the international server) and that the inverters, communication modules, and iSolarCloud support this function.

Lowest versions of the supported communication devices:

- WiFi-P2: WIFI-SV300.001.00.P007
- WiNet-S: WINET-SV200.001.00.P036
- WiNet-S2: WINET-SV300.001.03.P023
- Logger1000: LOGGER-SV300.001.00.P056

Please contact SUNGROW for the supported inverter models.

Step 1 Click **Time-of-use feed-in power limitation**.

Step 2 In the field **Preset feed-in power limit**, enter the target value.

If the feed-in power limit is pre-defined, the system will continue its operation as configured when the device is offline. To comply with the grid requirements, the preset value should not be too high.

Step 3 Set the time plans.

- a. Select the repeated days.
- b. In the power limit time periods, click, drag, and drop certain time frames for limited-power operation. Multiple time frames are supported. Outside the defined time frames, the operation power is not limited.
- c. Click the added time frame, enter the **Power limit** in the pop-up window, choose **Confirm**. Outside the defined time frames, the power is not limited.
- d. To add more time plans, click **Add schedule** for corresponding settings.

• Preset feed-in power limit(kW) ⓘ

25.36

Range:[0.00 - 655.35]

Schedule 1 ⓘ

Repeated Working days x Sat x

The inverter ignores limits during unscheduled slots

Power limit period 02:00 - 06:00
Power limit: 0.00kW >

00:00 01:00 02:00 03:00 04:00 05:00 06:00 07:00 08:00 09:00 10:00 11:00 12:00 13:00 14:00 15:00 16:00 17:00 18:00 19:00 20:00 21:00 22:00 23:00 24:00

Schedule 2 ⓘ

Repeated Sun x

The inverter ignores limits during unscheduled slots

Power limit period 07:00 - 08:00

00:00 01:00 02:00 03:00 04:00 05:00 06:00 07:00 08:00 09:00 10:00 11:00 12:00 13:00 14:00 15:00 16:00 17:00 18:00 19:00 20:00 21:00 22:00 23:00 24:00

Close Save

Step 4 Click **Save**.

--End

2.3.8.1.4 Digital Output Devices Setup

The card **Digital output devices setup** displays the operating mode and status of the digital output (DO) devices.

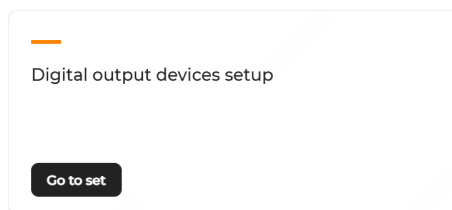

Step 1 Click the button **View** in the tile for details.

Step 2 Enable the option **Digital output devices setup** and set up an operating mode suitable for your actual needs.

The following operating modes are available:

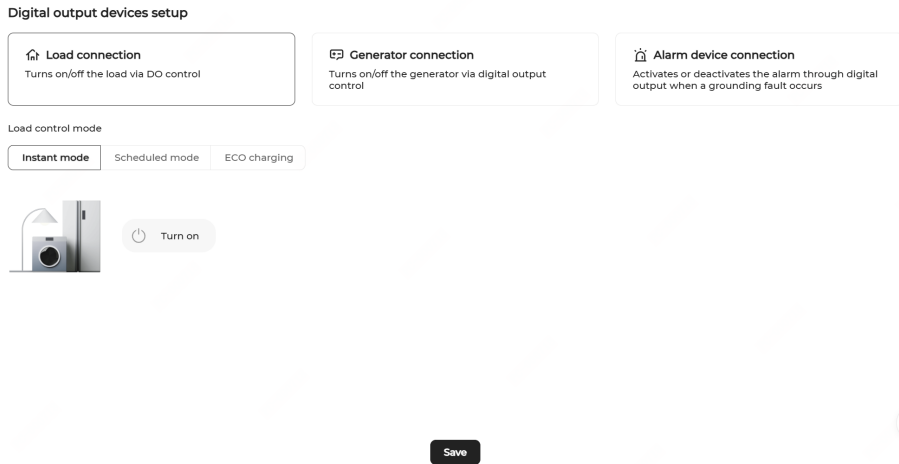

- **Load connection:** Turns on/off the load via DO control. For details, see [2.3.8.1.4.1 Load Connection](#).
- **Generator connection:** Turns on/off the generator via DO control. Ensure that a generator is connected to the DO port beforehand. After the connection, switch to **Microgrid mode** in the energy management mode to control the generator.
- **Alarm device connection:** Activates or deactivates the alarm through digital output when a grounding fault occurs. Ensure that an alarm device is connected to the DO port beforehand. After the connection, the device will issue an alarm if a ground fault occurs.

Step 3 Click **Save**.

--End

2.3.8.1.4.1 Load Connection

When **Load connection** is chosen for the option **Digital output devices setup**, choose one of the following methods to control the loads.

- **Instant mode:** Click **Turn on** or **Turn off**, and the device will immediately take actions.
- **Scheduled mode:** The devices will be automatically turned on or off according to the preset operating time periods.



- **ECO mode:** In this mode, set up **Load rated power** and **Load startup start and end time**. If PV power is sufficient, loads are started according to scheduled start and end time.

Load control mode

Instant mode Scheduled mode **ECO charging**



Start loads according to scheduled periods if PV power is sufficient

Load rated power(kW) Range:[0.00 - 600.00]

Load startup start and end time - 

Save

2.3.8.2 Device Parameters

This function enables you to view and define parameters for the devices in a plant.

You can search and filter the parameters by device type, device model, and device serial number.

Schnelleinstellung **Geräteparameter** Allgemeine Informationen Tarif

Hybrid (speicherfähig) 

<input type="checkbox"/>	Anlagenname	Gerätename	Netzverbindungsstatus	Geräte-S/N	Gerätemodell	Land (Region)	Aktion
<input type="checkbox"/>	*****	*****	Bereits gesetzt	A2024032701	SH25T-V11	Australien	

Parameter Settings

In the device list, click the icon  in the **Action** column to configure the device parameters. For details, see [2.3.8.2.1 Device Settings](#).

Batch Settings

Select multiple devices in the device list and click **Batch settings** in the upper right corner of the page to set up a group of devices at one time.

View Task History

Click the icon  in the upper right corner of the page to enter the **View task history** page for details.

2.3.8.2.1 Device Settings

You can view and configure the parameter settings for devices.

Step 1 In the Action column on the Device list page, click the icon  to go to the Settings page.

The screenshot shows a settings page for a device. At the top, there is a search bar labeled 'Enter a keyword' with a magnifying glass icon. Below it, there are several sections of settings:

- Startup/shutdown:** A toggle switch is turned on.
- Digital output devices setup:** A link labeled 'Disable >' is visible.
- Protection parameters:**
 - Protection level:** A dropdown menu with 'Please select' as the current option.
 - 10-minute overvoltage protection:** A toggle switch is turned on.
 - 10-min overvoltage protection threshold (V):** A text input field containing '258.0' with a range of '[230.1-322.0]' below it.
 - 10-min overvoltage recovery threshold (V):** A text input field containing '256.0' with a range of '[230.0-321.9]' below it.
 - Criteria for islanding detection:** A dropdown menu with 'Disable' as the selected option.
 - LVRT protection level:** A dropdown menu with '2' as the selected option.
 - LVRT zero power mode:** A toggle switch is turned on.
- LVRT voltage (V) and LVRT time (ms) table:**

	LVRT voltage (V)	LVRT time (ms)
1	180.0 Range: [0.0-230.0]	10000 Range: [40-14,400,000]
2	70.0 Range: [0.0-230.0]	1000 Range: [40-14,400,000]
- LVRT grid unbalance support:** A toggle switch is turned off.
- LVRT K factor:** A text input field containing '0.0' with a range of '[0.0-10.0]' below it.
- HVRT zero power mode:** A toggle switch is turned on.
- HVRT protection level:** A dropdown menu with '1' as the selected option.

At the bottom right, there are two buttons: 'Refresh' and 'Save'.

Step 2 Complete the settings.

According to the parameter types available in the device, configure the parameters below, for example,

- Startup/shutdown
- Energy management mode
- Digital output devices setup
- Protection parameters
- Power control
- Battery parameters

Step 3 Click **Save**.

More functions:

- Parameter query: Find a specific parameter via search.
- Navigation bar: Click the navigation bar on the right to go to the corresponding section on the page.
- Records: Click the button **Records** in the upper right corner of the page to view the history of setting activities performed for this specific device.

--End

2.3.8.3 Plant Information Setting

The current account should have the permission to edit the plant information.

Procedure

- Complete plant information and owner information
For description of parameters, see [2.2.1 Create One Plant](#).

- Complete other information

Parameter	Description
Retailer/Installer Organization Code	Code of the retailer/Installer to which the plant belongs.
Module Model	Model of the PV module connected to the inverter.
Channel/Partner	To allow a third-party service provider to check or manage the current plant.
Plant Delivery Zip	Postal code for the place of receipt of spare parts.
Plant Delivery Address	Shipping address of spare parts.
Reset Password	Click Settings to reset the account password.

2.3.8.4 Set Tariff

Step 1 Set basic information: Select a currency from the **Currency** drop-down list.

Step 2 Set **Consumption tariff**: Select from the following tariff types:

- Fixed tariff
- Time-of-use tariff
- Time-of-use tariff (working days + non-working days)
- Tiered tariff
- Dynamic tariff



This section describes how to configure dynamic tariff. For detailed descriptions of other tariff methods, refer to [2.2.1.3 Set tariff](#).

Dynamic tariff is a flexible pricing strategy. Once set, you can view real-time market electricity prices and make household consumption more efficient and intelligent.



Currently, only users in certain countries can set dynamic tariffs when purchasing iHomeManager. The function availability is subject to the actual page display. If you wish to expand the countries to which the dynamic tariff function is applicable, contact Sungrow Customer Service at any time.

- Select **Dynamic tariff**.
- Select **Tariff source**.
- Select the **Bidding zone**, or **Region** and **Tariff plan** as applicable.



The page display may vary depending on the selected **Tariff source**. Please refer to the actual display.

After the configuration is complete, the dynamic tariff trend of the bidding zone will be displayed on the page.

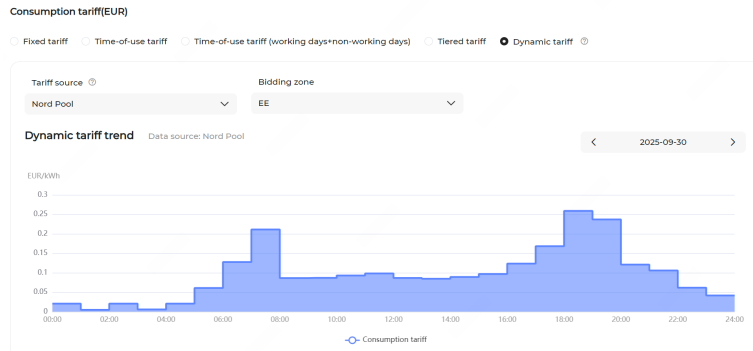

d. Taxes & markup: If needed, enable **Taxes & markup**, and set the **VAT** and **Surcharge** to adjust the Consumption tariff.

Taxes & markup

VAT (%) Range:[0-99]

Surcharge (EUR/kWh) Range:[0.00000-99.99999]

i Calculation formula for the electricity taxes and markup:
(1+VAT) × (spot price + surcharge)
 VAT: Additional charge applied as a percentage of the total electricity fee for a billing period.
 Surcharge: All the extra fees you need to pay per kWh (e.g. grid fees, taxes and levies, service fees, renewable energy surcharges).

Example: Quickly set electricity tariffs

Table 2-5 Electricity Tariffs of a Power Company (Excluding Tax)

Item	Price	Remarks
Electricity tariff	Hourly spot price set by the power exchange	Excluding tax
Grid consumption fee	0.24 NOK/kWh	
Energy tax	0.32 NOK/kWh	
VAT: 25%		

Enter 25 in **VAT (%)** based on the VAT, and enter 0.56 in **Surcharge (NOK/kWh)** based on the sum of the grid consumption fee and energy tax.

Step 3 Set **Feed-in tariff**: Similar to setting **Consumption tariff**. Choose the appropriate tariff billing method.

Step 4 Click **Save**.

If the communication equipment includes iHomeManager and the current energy management mode is not AI Mode, when you set the tariff mode to Dynamic tariff and click **Save**, the following prompt will be displayed.

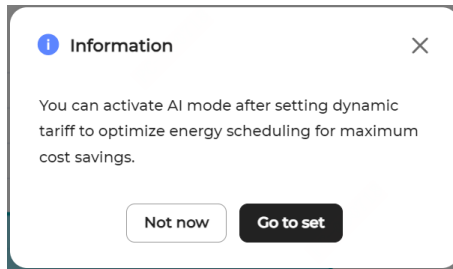

To activate AI Mode now, click **Go to set** to go to the Energy management page for configuration. For detailed instructions, see [3.3.2.2.1.1 AI Mode](#).

--End

2.3.9 Layout Settings

On the **Plant** page, click a plant name. You are directed to the **Overview** page by default. Then, choose **Layout Settings** on the left to go to the page for layout setting.

After optimizers or RSDs have been installed, you can set up the layout in the iSolarCloud system. Before proceeding with the layout setting, make sure you have completed the following steps:

1. Turn on the AC switches of all inverters, and turn off all DC switches.
2. Create a plant. See [2.2 Create Plant](#) for details.
3. Set up layouts based on the plant type. See [2.3.9.1 Layout Setup for C&I PV Plant](#) or [2.3.9.2 Layout Setup for Residential PV Plant](#) for details.

2.3.9.1 Layout Setup for C&I PV Plant

For a C&I PV plant, it is recommended to complete the layout setup by importing an Excel layout file.



To save time during plant creation and commissioning, if the Excel layout template is available, you can create an Excel layout file in advance based on the template during on-site installation.

Step 1 Create an Excel layout file (skip this step if one is already created).

To obtain the Excel layout template, use one of the following download methods:

- a. Click https://file.isolarcloud.com/template/optimizer_sn_import/optimizer_sn_import_template_en_US.xlsx to download the template.
- b. On the **Layout Settings** page, click **Import Layout File** and then click **Click to Download Template**.

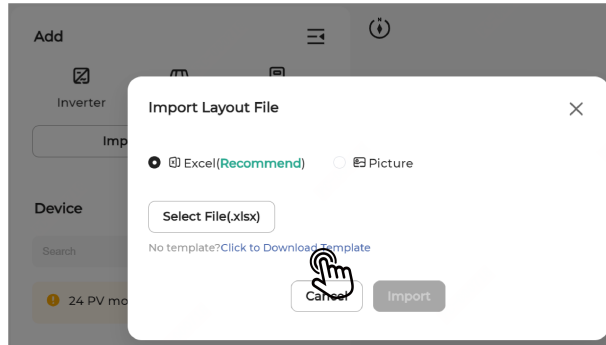

- c. On the **Layout Settings** page, click ↓ next to **Import Layout File** and choose **Download Template**.

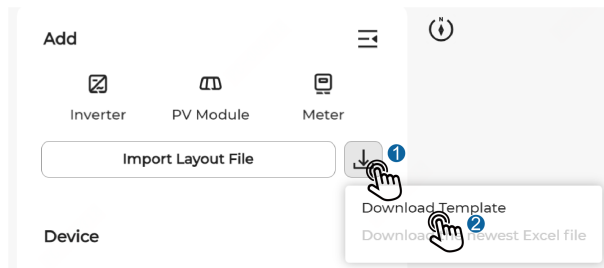

Follow the instructions on the **Demo** sheet to fill in layout data on the **Layout** sheet based on the actual physical layout of the plant.

NOTICE

You must strictly follow the instructions in the Excel template. The Demo sheet cannot be modified or adjusted.

Layout Template

Illustrate:

1. Please fill in the actual layout.
2. Fill in the actual inverter S/N and define the inverter number (the number starts from 1).
3. Fill in the S/N and the number of each optimizer/RSD following the rule: **inverter number-inverter string number-optimizer/RSD number** (e.g., the number of the first optimizer/RSD of the first inverter in the first string is 1-1-1).
4. Paint the cell where there is a PV panel but no optimizer with black, as shown in the figure.

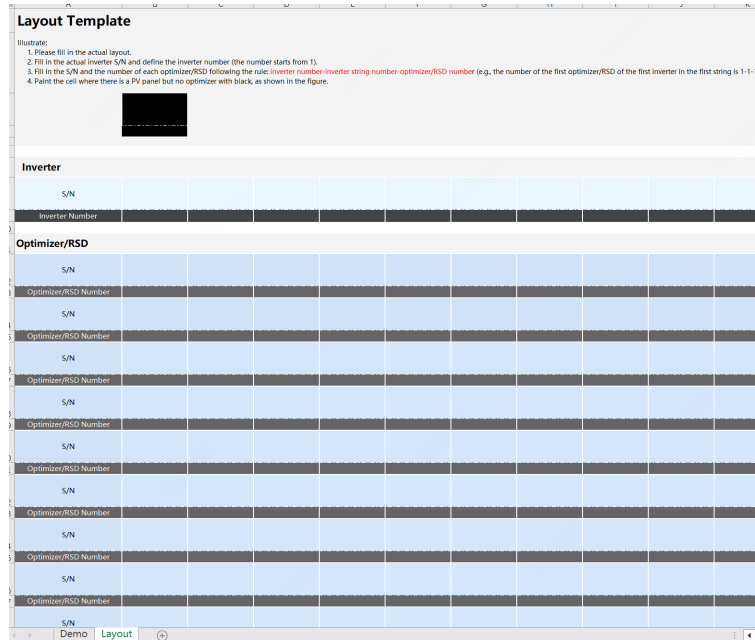

Inverter	
S/N	Inverter Number
Optimizer/RSD	
S/N	Optimizer/RSD Number
S/N	Optimizer/RSD Number
S/N	Optimizer/RSD Number
S/N	Optimizer/RSD Number
S/N	Optimizer/RSD Number
S/N	Optimizer/RSD Number
S/N	Optimizer/RSD Number
S/N	Optimizer/RSD Number
S/N	Optimizer/RSD Number

- Fill in the inverter S/N and assign a number to the inverter (starting from 1).
- Fill in the S/N and number of each optimizer/RSD. Follow the following format for the optimizer/RSD number: **inverter number-inverter string number-optimizer/RSD number** (e.g., the number of the first optimizer/RSD of the first inverter in the first string is 1-1-1).



In 2-in-1 optimizer/RSD scenarios where two modules are connected to a single optimizer/RSD, fill the same optimizer/RSD S/N and optimizer/RSD number for both modules in the Excel template.



It is recommended to use a QR code scanner to fill the optimizer/RSD S/N. Scan the QR code on the label of a device to automatically fill the S/N in the corresponding position of the Excel template.

- For the optimizer/RSD S/N and optimizer/RSD number, you can add rows and columns based on actual needs (up to 1000 rows and 1000 columns).

NOTICE

After completing the layout file, check against the following checklist to prevent import or parsing failures:

- The inverter S/N and inverter number cannot be empty or duplicated. The inverter number must be a number.
- The optimizer/RSD S/N and optimizer/RSD number cannot be empty or duplicated. The S/N must be 11 digits in length and cannot contain spaces.
- The imported Excel file cannot be empty or encrypted, or contain formulas.
- The same S/N cannot be contained on multiple canvases.
- No more than 35 optimizers/RSDs can be connected to a single string.
- The string number contained in the optimizer/RSD number cannot exceed 36.

Step 2 Import the Excel layout file.

Before importing the layout file, please set the Optimizer/RSD-module ratio to the actual ratio for the current layout. In 2-in-1 optimizer/RSD scenarios where two modules are connected to a single optimizer/RSD, set the Optimizer/RSD-module ratio to 1:2.

To set the Optimizer/RSD-module ratio, click **...** > **Edit** > select an appropriate **Optimizer/RSD-module ratio** in the **Edit Physical Layout** window, and then click **Confirm**.

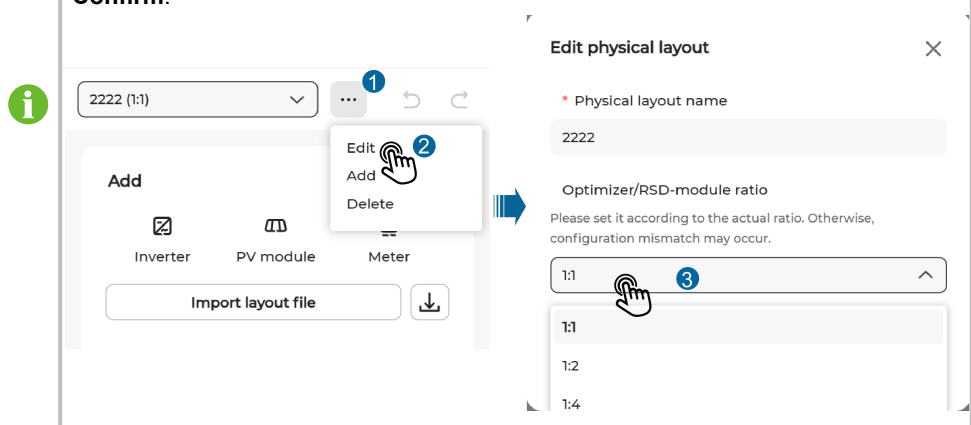

Click **Import Layout File**. In the **Import Layout File** pop-up window, choose **Excel**, click **Select File(.xlsx)**, select the file to be imported, and then click **Import**. The import progress of the layout file will be displayed on the page.



Step 3 View import results and handle exceptions.

After the import is complete, the system returns the **Layout import successful** message and redirect to the **Layout** page. You can view the imported layout.

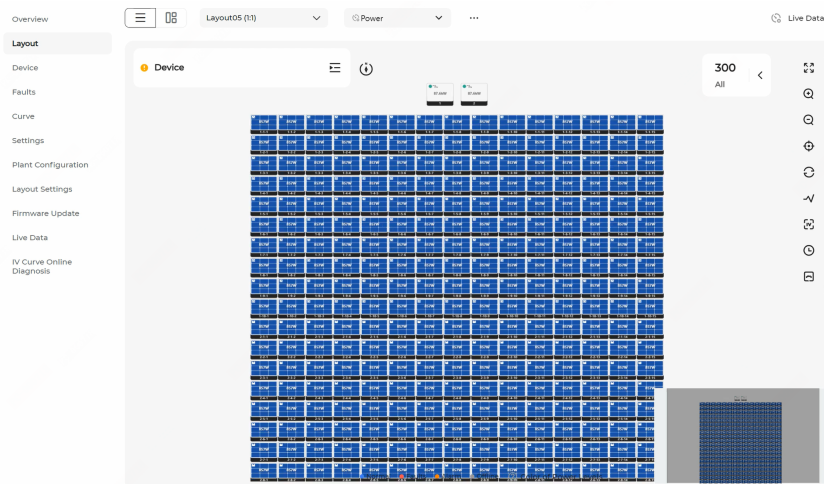

Take corresponding measures to handle exceptions.

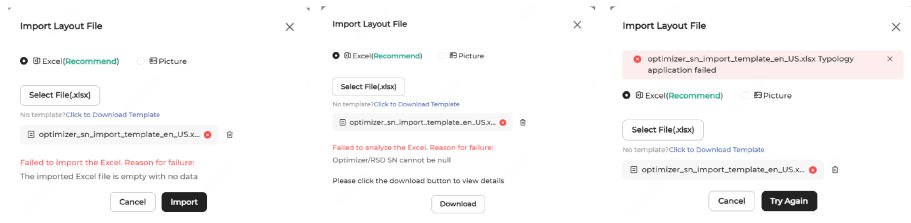

- If the Excel layout file fails to be imported or parsed, the failure reason will be displayed in the **Import Layout File** pop-up window. Modify the file accordingly and re-import it.
- To view details about the file that failed to be parsed for quick troubleshooting, click **Download**.

- If the topology fails to be applied, a prompt will be displayed in the pop-up window. Try again or try another file.

Step 4 If a module fails to be recognized, manually add the module and associate an optimizer/RSD S/N with it:

- Drag and drop the icon  to the layout. Then, fill in the module information such as **Row**, **Column**, **Azimuth Angle**, and **Tilt Angle**, and click **Confirm**.

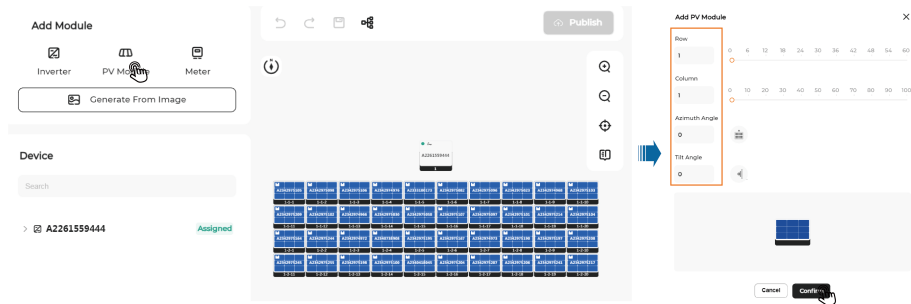

- Click the module, and click **Assign**. Then, select the S/N of the corresponding optimizer/RSD to associate it with this module.

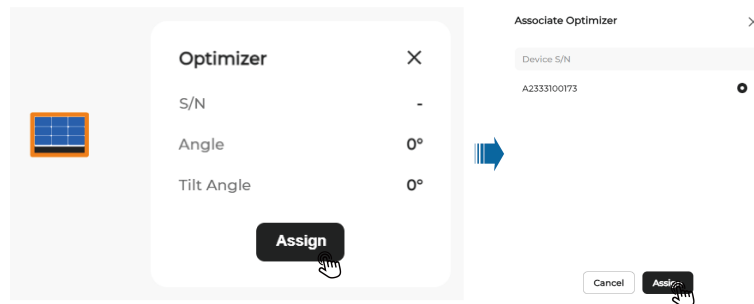

Step 5 Adjust the position or orientation of modules as needed.

Press and hold Ctrl, select the modules to be adjusted on the canvas, and then drag or rotate them.

Step 6 Set up the logical layout:

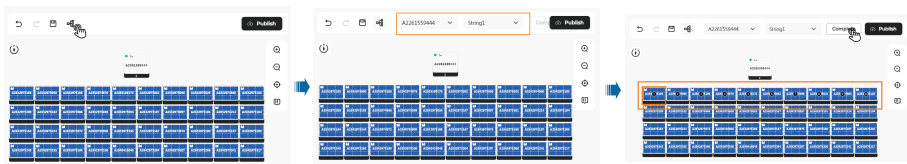



- Click  to select the inverter and string to be set.
- Click to drag the modules and arrange them in the correct order based on the actual wiring of the optimizers/RSDs, and then click **Complete**.
- In case modules are arranged incorrectly, right-click a module and choose **Clear**. After confirmation, the optimizer/RSD numbers of the current and subsequent modules will be cleared.

Step 7 Re-import the layout file if there are changes to the devices in the plant.

NOTICE

Re-importing the layout file for a layout will clear all current settings of the layout.

You can download the most recently uploaded history file by using one of the following methods, make adjustments, and then re-import it.

- Click **Import Layout File** and then click .
- Click  next to **Import Layout File** and choose **Download the newest Excel file**.

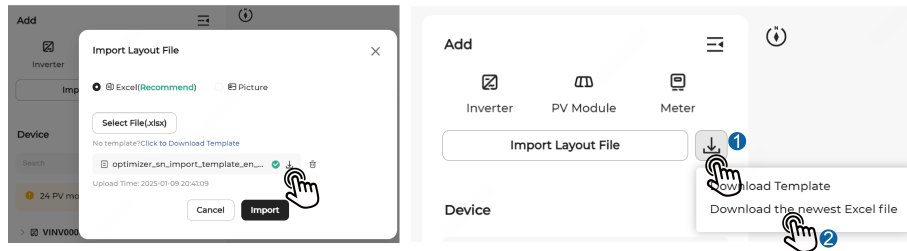

Step 8 After completing the layout setup, tap  in the upper right corner of the page to publish the layout.



If you do not want to publish the layout immediately, you can click  to save the current layout settings.

Step 9 If a plant is geographically scattered, add multiple layouts for the plant.

Click  at the top of the page, choose **Add**, set the **Physical Layout Name** and **Optimizer/Module Ratio**, and then click **Confirm**.

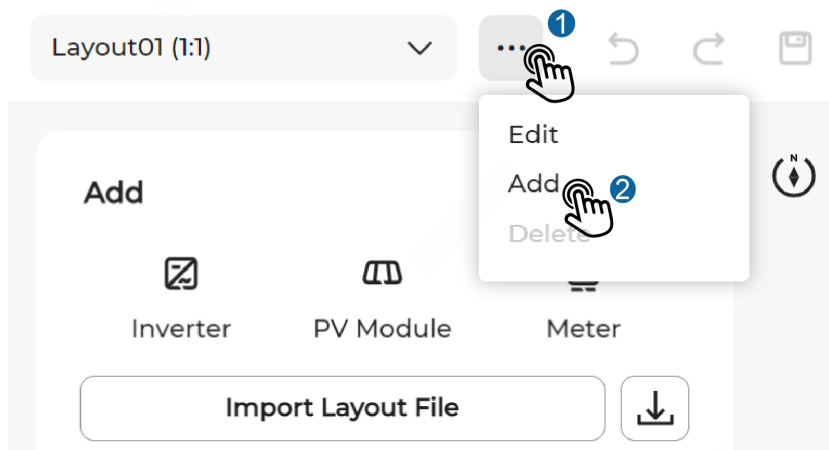

--End

2.3.9.2 Layout Setup for Residential PV Plant

Residential PV plant layouts on different servers are set up differently:

- On the European server, the setup is done by importing the Excel layout file. See [2.3.9.1 Layout Setup for C&I PV Plant](#) for details.
- On other servers, the setup is by importing the physical layout template picture. The procedure is explained below in this chapter.



The physical layout template is included in the scope of delivery of optimizers/RSDs. For usage instructions, refer to the guidance on the template.

Step 1 Click **Import layout file**, choose  to upload the picture of the physical layout template for the plant, and click **Start recognition**. The import progress of the layout file will be displayed on the page.

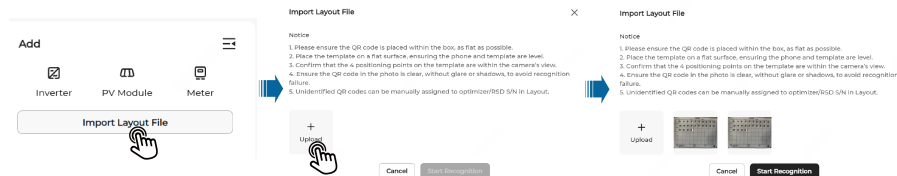

NOTICE

- **Do not take photos of the physical layout template under strong light. Otherwise, the QR code may not be recognized due to the reflection of light.**
- **Turn off the live photo function on the phone when taking photos and upload a still photo. Otherwise, the QR code may not be recognized successfully.**
- **Check the recognition result carefully. If the QR code cannot be recognized due to damage or folding, manually add the optimizer/RSD by its S/N.**

Step 2 View the import results and handle exceptions.

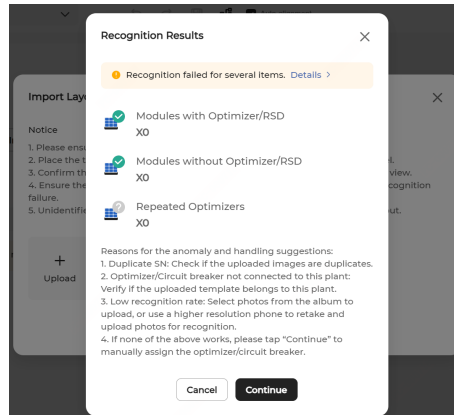

After the import is complete, the system returns the **Layout import successful** message and redirects to the layout page, where you can view the imported layout.

Handle exceptions, if any, according to the prompts on the page.



Step 3 To adjust the imported layout, see Steps 4 to 7 in [2.3.9.1 Layout Setup for C&I PV Plant](#).

Step 4 After completing the layout setup, click  in the upper right corner of the page to publish the layout.

 If you do not want to publish the layout immediately, you can click  to save the current layout settings.

Step 5 If a plant is geographically scattered, add the layouts for the other areas of the plant.

Click ******* > **Add** at the top of the page to define the physical layout name and Optimizer/RSD-module ratio, and then click **Confirm**.

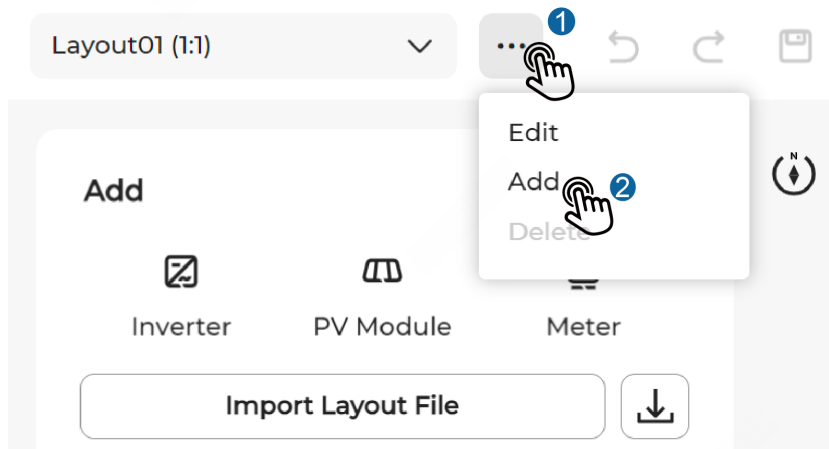

--End

2.3.9.3 Replace/Delete/Add Optimizer or RSD

Go to "Device" and switch to the card view. For details, see [2.3.5 Plant Device](#).

Replace Optimizer or RSD

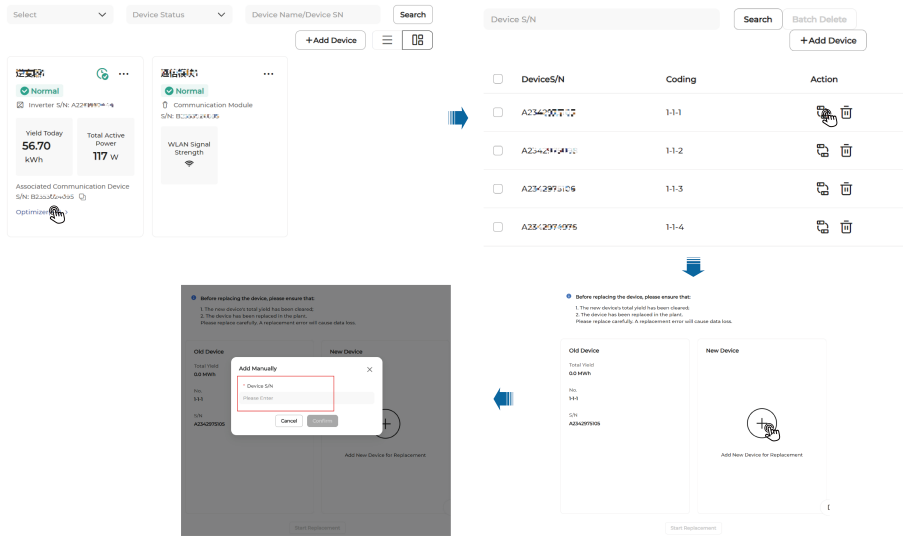

1. Click “Optimizer” or “RSD” at the bottom of the inverter card.
2. Find the S/N of the optimizer or RSD to be replaced, and click on its right.
3. Click , enter the S/N of the new device, and then click **Start Replacement**.

After replacement, the new device will take the place of the old device in the layout automatically and thus does not need to be added again.

Delete Optimizer or RSD

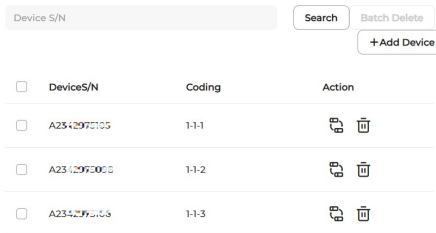

In the optimizer or RSD list, choose a device and click in the Action column, or select multiple devices and click **Batch Delete** in the upper right corner, to delete the device(s).

Add Optimizer or RSD

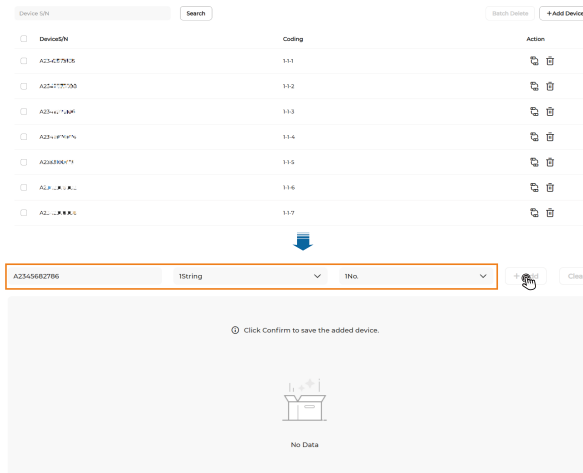

In the optimizer or RSD list, click **Add Device**. Then, enter the device S/N, select the string and the number, and then click **Add**. After the device has been added, click **Confirm** at the bottom of the page.

2.3.10 Firmware Update

Click on a plant name on the “Plant” page. You will go to the **Overview** tab page by default. Click **Firmware Update** on the left. Here you can update the device in the plant.

See [3.4 Firmware Update](#) for details.

2.3.11 Live data

Click on a plant name on the “Plant” page. You will go to the **Overview** tab page by default. Click **Live Data** on the left to go to the “Live Data” page.

See [4.4 Live data](#) for details.

2.3.12 IV Curve Online Diagnosis

Click on a plant name on the “Plant” page. You will go to the **Overview** tab page by default. Then, click **IV Curve Online Diagnosis** on the left to go to the “IV Curve Online Diagnosis” page.

See [4.5 IV Curve Online Diagnosis](#) for details.

2.3.13 Strategy Configuration

Click a plant name on the **Plant** page, and you will go to **Overview** by default. Choose **Strategy configuration** on the left. On the page that opens, configure **Energy management**, **Power control**, and **System settings** for the plant.



- The **Strategy configuration** function is only applicable to **Commercial & Industrial ESS** plants. The default control strategies may vary by region. Please refer to the actual interface.
- For configurations in Japan's HV scenarios, refer to *iSolarCloud O&M User Manual (Japan's HV Scenarios)*.

Procedure

- View history task

Click  in the upper right corner of the page to view the history of all strategy configuration commands for this plant.

2.3.13.1 Energy Management

2.3.13.1.1 Energy Management Mode

You can select appropriate control strategy to configure the charging and discharging power settings for different time periods based on electricity rates across different periods. The ESS will charge or discharge at the specified power within the specific time periods, thereby reducing electricity costs.

2.3.13.1.1.1 Self-Consumption

This mode makes the PV installation and the battery cover the most of the loads' demand, reducing energy import from the grid. Users can set different battery charging/discharging time windows based on electricity prices at different times to reduce the electricity cost.

Step 1 Choose **Energy management > Energy management mode**.

Step 2 Select the **Self-consumption** mode.

Step 3 Enable or disable **Peak shaving mode**. It is disabled by default.

If **Peak shaving mode** is enabled, you must set the **Reserved SOC for peak shaving (%)** within the range of 0–100. Default value: 70.

The **Reserved SOC for peak shaving** must meet the following constraints. Otherwise, the setting will not take effect.



- Reserved SOC for peak shaving (%) \geq Power backup lower SOC threshold \square % \square +2%;
- Reserved SOC for peak shaving (%) must not exceed the **SOC upper limit**.

Step 4 Set a power upper limit for the system to purchase energy from the grid in **Threshold on power purchase (demand control) (kW)**. Default value: 0. When the energy purchase power exceeds this threshold, the excess power will be drawn from the battery, helping reduce the user's electricity cost.

The power supply priority for the loads is: PV > grid (within threshold) > battery.

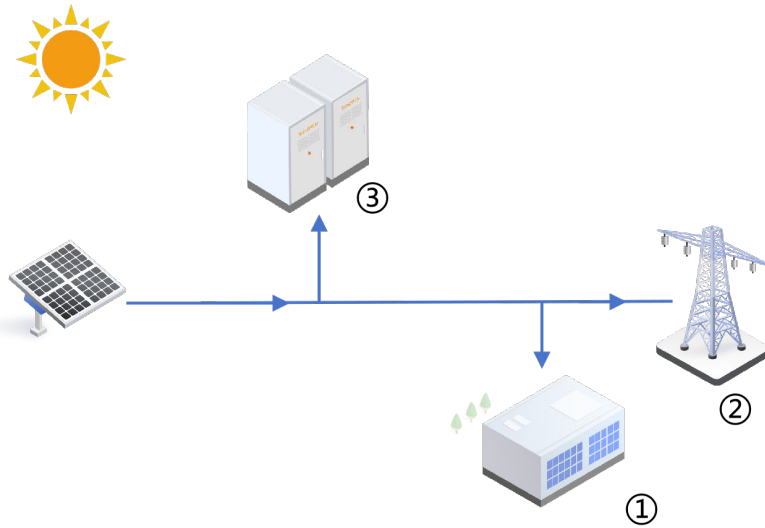

This threshold does not apply during forced charging time periods. In this case, the limit is determined by the **Power limit for energy purchase** set in Grid-connected power control. If **Purchase energy with limited power** is not enabled, there will be no restriction on battery charging.

Step 5 Set a power upper limit for the system to feed energy into the grid in **Threshold on power feed-in (demand control) (kW)**. Default value: 0. After you configure this threshold, the system prioritizes load demand, and the surplus PV power is fed into the grid. Only when the feed-in power exceeds this threshold, the excess power will be absorbed by charging the battery.

The consumption priority of PV power is: Load > grid (within threshold) > battery.

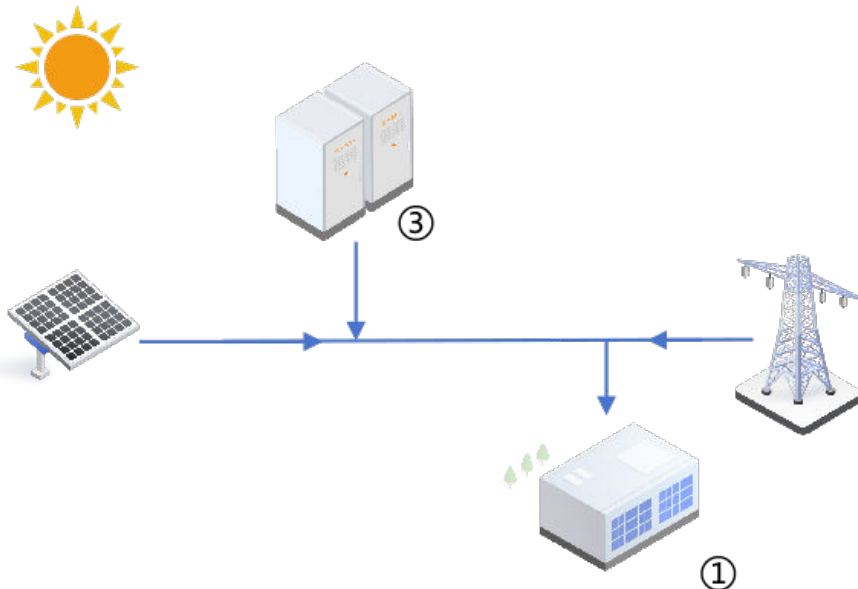

Step 6 Enable **Custom time period** to add a battery usage plan. Users can create custom charging/discharging time windows, allowing the system to make the most of the PV output in on-peak hours and charge the battery properly in off-peak hours. In this way, electricity cost is reduced.

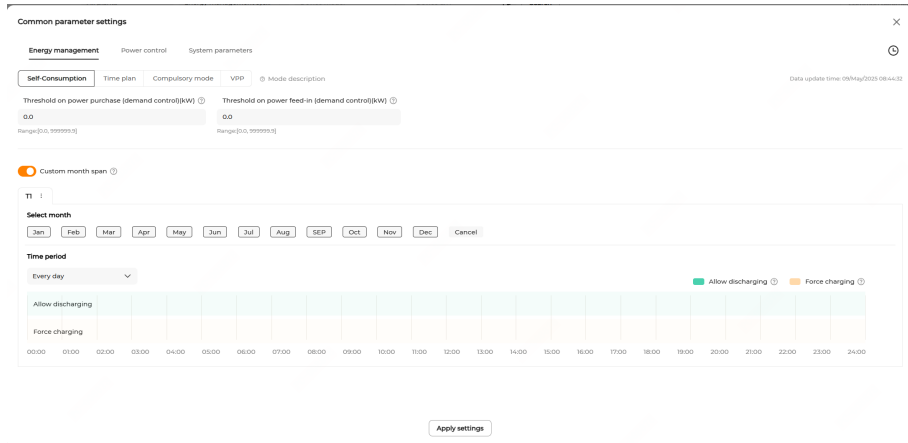

- a. Select months in the **Select month** section.
You can set different time windows based on seasonal energy demand patterns.
- b. In the **Time period** section, select the days on which the battery charging/discharging plan applies.
You can apply the charging/discharging plan to every day, or set different charging/discharging plans respectively for working days & non-working days. The plan applies to every day by default.
 - **Every day:** The default option, indicating the set charging/discharging plan applies on all days.
 - **Working days & non-working days:** Set different charging/discharging plans for weekdays and weekends.
- c. Set the battery discharging and forced charging windows within a day.
 1. Tap a time period in the **Allow discharging** time bar. Then, drag the left or right edge of the window to adjust the length of time. A new discharging window will be created (with the minimum granularity of 15 minutes). The battery is allowed to discharge to supply the loads in the specified time period.
 2. Tap a time period in the **Force charging** time bar. Then, drag the left or right boundary of the window to adjust the length of time. A new charging window will be created (1 hour by default). Click the added time window, and in the pop-up dialog box, enter the target charging SOC in **Target SOC**.
In the specified time period, the battery is charged at its maximum allowable power until reaching the preset target SOC.



- Battery discharging and forced charging windows can overlap. If a time window allows both battery discharging and forced charging, forced charging will be executed first.
- Outside of the configured time periods, the battery is not allowed to discharge or be charged by drawing power from the grid. In this case, the battery can only be charged by PV power.

Step 7 Click **Apply settings**. In the pop-up window, enter the **Task name**, set the **Instruction valid period**, and click **Confirm**.

--End

2.3.13.1.1.2 Time Plan

The **Time plan** mode is mainly used in electricity transaction scenarios. You can set the time windows and power for battery charging/discharging manually, according to the on- and off-peak electricity prices, to maximize the economic benefits.

It is recommended to allow the battery to discharge during on-peak hours (when electricity prices are higher) and charge during off-peak hours (when electricity prices are lower).

Function Logic

- Discharging window: The battery discharges at the predefined discharging power within the set time period until it is fully discharged.
- Charging window: The battery charges at the predefined charging power within the set time period until it is fully charged.

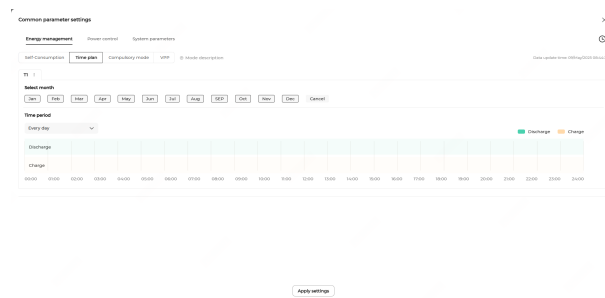

Step 1 Navigate to the **Energy management** page and select the **Time plan** mode.

Step 2 Set the desired month span. You can set different time windows based on seasonal energy demand patterns.

Step 3 Select the days on which the battery charging/discharging plan applies.

You can apply the charging/discharging plan to all days, or set different charging/discharging plans for weekdays and weekends. The plan applies to every day by default.

- **Every day:** The set charging/discharging plan applies on all days. This option is ideal for scenarios where the daily electricity price is relatively consistent.
- **Weekdays & weekends:** Set different charging/discharging plans for weekdays and weekends.

Step 4 To add more month spans, click **Add** to the right of the default month span name.



Before adding a month span, you must first configure the charging and discharging time periods for the current season.
 You can select a month span and click to modify its name or delete it.

Step 5 Tap a time period in the **Discharge** or **Charge** time bar. A new discharging or charging window will be created (1 hour by default). Then, drag the left or right boundary of the window to adjust the length of time.



The charging and discharging windows cannot overlap.
 The battery will not discharge in a time period with no settings. If the PV output is insufficient, the system purchases energy from the grid to meet the load demand, and allows the battery to charge from the excess PV energy.

Step 6 Click a time window that has been added, set the discharging or charging power in **Power**.

Step 7 Click **Apply settings**.

--End

2.3.13.1.1.3 Time-of-Use Strategy Settings

This strategy is mainly used to customize the switching between self-consumption mode and time plan mode by time periods so as to maximize economic benefits.



This feature is available on EMS300CP-SV100.001.00.P027 or later.

Step 1 Click **Time-of-use strategy settings**.



Step 2 Select **Enable** in **Function enable/disable** to enable the time-of-use strategy.



When the Time-of-use strategy is enabled, the execution priorities of Energy management mode is lower than those of the Time-of-use strategy.

Step 3 In the **Time** drop-down list, select the days on which the battery charging/discharging plan applies.

You can apply the charging/discharging plan to every day, or set different charging/discharging plans respectively for working days and non-working days.

- **Every day** (default): The set charging/discharging plan applies on all days.
- **Working days & non-working days**: Set different charging/discharging plans respectively for working days and non-working days.

Step 4 Set the operating time periods for self-consumption mode and time plan mode within a day.

- Tap a time period in the **Self-consumption** time bar. Then, drag the left or right edge of the window to adjust the length of time. A new time window will be created (with the minimum granularity of 15 minutes).
- Click the time window. In the **Settings** window, set the **Peak shaving mode**, **Threshold on power purchase (demand control) (kW)**, and **Threshold on power feed-in (demand control)(kW)**. During the specified time period, the system operates according to the self-consumption strategy. For details, see steps 3 to 5 in [2.3.13.1.1.1 Self-Consumption](#).
- Tap a time period in the **Time plan** time bar. Then, drag the left or right edge of the window to adjust the length of time. A new time window will be created (with the minimum granularity of 15 minutes). Within the specified time period, the system operates according to the time plan strategy.



The time periods for self-consumption and time plan modes cannot overlap.

Step 5 Click **Apply settings**. In the pop-up window, enter the **Task name**, then click **Confirm**.

--End

2.3.13.1.1.4 Time-of-Use Power

In this mode, the ESS automatically adjusts output power according to the specified power in preset time periods to respond to time-of-use tariffs and maximize revenue.

Time-of-use power management consists of two key steps:

- Configure time-of-use power templates: Define the charging and discharging schedule for various periods within a day. The configured templates are stored in the template list for future use.
- Configure time-of-use power strategies: Select a period and apply predefined time-of-use power templates.

2.3.13.1.1.4.1 Configure Time-of-Use Power Templates

Step 1 On the **Energy management** page, click **Energy management mode** and select **Time-of-use power**.

Step 2 When you enable time-of-use power for the first time, a time-of-use power template must be created to define the charging and discharging schedule for different time periods. The system supports two time granularities: 30-minute interval, and 1-second interval. The following sections provide detailed setup instructions for each.

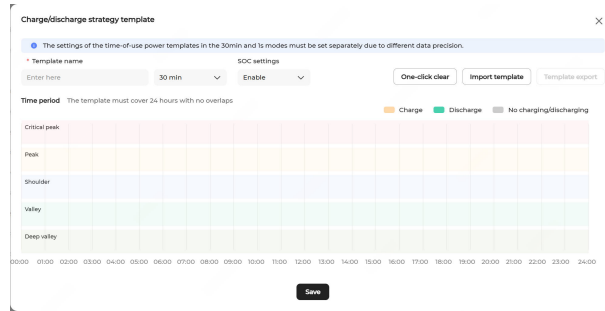

i The first created time-of-use power template is designated as the default template, which can be modified but not deleted.

• **30-Minute Interval Configuration:**

i The following steps demonstrate how to manually configure the charging and discharging schedule for a day. Alternatively, an existing template can be imported using the **Import template** button.

a. Enter a custom **Template name**.

b. Select **30 min** as the time unit.

c. Configure **SOC settings**.

- **Enable:** To configure the ESS charging/discharging settings for a time period, you must set the **SOC target value (%)**. The ESS automatically stops the current operation when the SOC reaches the specified target value.
- **Disable (default):** The ESS continues to operate at the configured charging/discharging power throughout the time period.

d. Click the **Critical peak**, **Peak**, **Shoulder**, **Valley**, and **Deep valley** sections respectively to select time blocks. Drag the handles on the two sides of the selected block to adjust its duration.

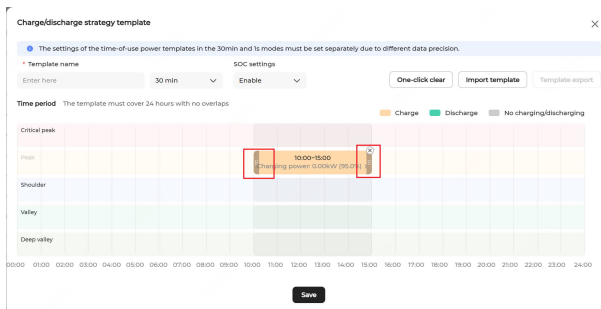

To delete a selected time period, click the **Close** icon in the upper right corner of the selected block.

e. Click a time block to configure charging and discharging parameters. Click **Confirm** to apply the settings.

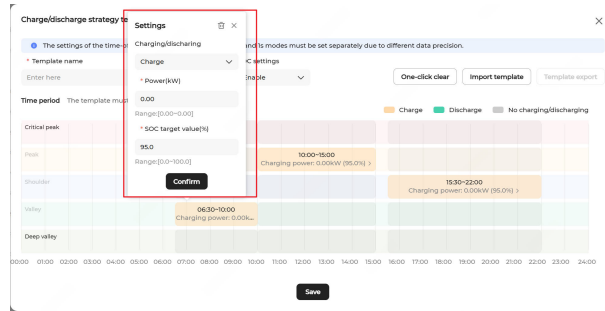

Charging/discharging: Select **Charge**, **Discharge**, or **No charging/discharging**.

Power(kW): Set the charging and discharging power based on actual needs.

SOC target value (%): When **SOC settings** are enabled, this parameter must be configured for both charging and discharging time periods. The default value is 95 for charging periods and 5 for discharging periods. The valid range is [0, 100].

- f. Click **One-click clear** in the upper right corner to delete all configured time periods.
- g. Repeat steps d to e until the entire 24-hour period is defined without overlaps.
- h. Click **Save** to save the settings.
- i. The created template will appear in the Template list on the right panel.

• **1-Second Precision Configuration:**

 The following steps demonstrate how to manually configure the charging and discharging schedule for a day. Alternatively, an existing template can be imported using the **Import template** button.

- a. Enter a custom **Template name**.
- b. Select **1 s** as the time unit.

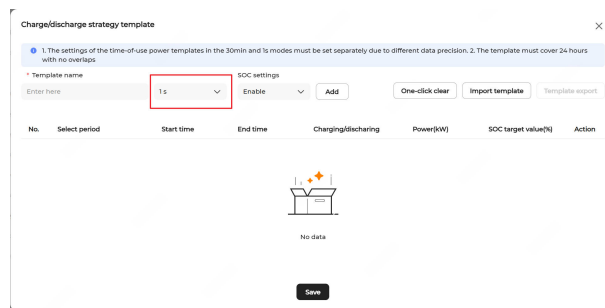

- c. Configure **SOC settings**.
 - **Enable:** To configure the ESS charging/discharging settings for a time period, you must set the **SOC target value (%)**. The ESS automatically stops the current operation when the SOC reaches the specified target value.
 - **Disable** (default): The ESS continues to operate at the configured charging/discharging power throughout the time period.
- d. Click **Add** and configure the following parameters:

Parameter	Description
Select period	Click  to choose from Critical peak, Peak, Shoulder, Valley, and Deep valley.
Start time	Set the start time (in HH:MM:SS format).
End time	Set the end time (in HH:MM:SS format).
Charging/ discharging	Select a status for the period from Charge, Discharge, or No charging/discharging.
Power (kW)	Enter a fixed power value, up to the rated power.
SOC target value (%)	When SOC settings are enabled, this parameter must be configured for both charging and discharging time periods. The default value is 95 for charging periods and 5 for discharging periods. The valid range is [0, 100].

- e. Repeat step d until the entire 24-hour period is defined without overlaps.
- f. Click **Save** to save the settings.

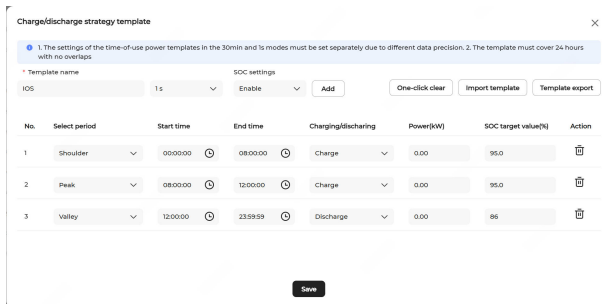

- g. The created template will appear in the Template list on the right panel.

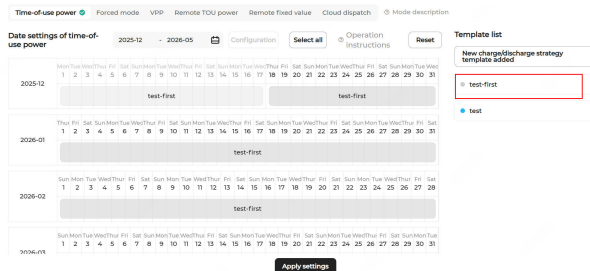

Step 3 (Optional) Add a charge/discharge strategy template. If the existing templates do not meet requirements, a new template can be added.

- a. Click **Add charge/discharge strategy template** above the template list.

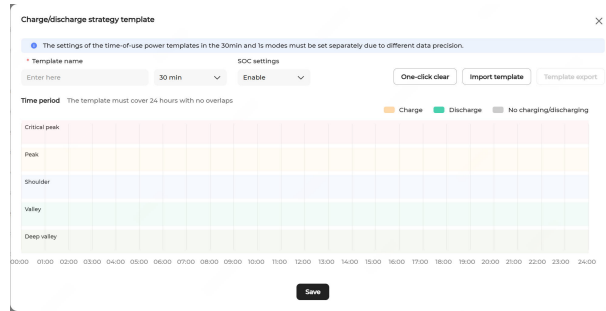



- b. Configure the template following step 2.
- c. The created template will appear in the Template list on the right panel.



Up to 10 charge/discharge strategy templates are supported.

Step 4 (Optional) Modify a charge/discharge strategy template. Click the Edit icon  of the desired template to edit it.

Step 5 (Optional) Export a template. Click the Edit icon  of the desired template and click **Template export** in the upper right corner to export the template to local system.

Step 6 (Optional) Delete a charge/discharge strategy template. Click the Delete icon  of the desired template to delete it.

--End

2.3.13.1.1.4.2 Configure Time-of-Use Power Strategies

Step 1 On the **Strategy configuration** page, choose **Energy management > Energy management mode > Time-of-use power**.

Step 2 Click the calendar icon highlighted in the figure below to select a target period (e.g., a specific month).



The system applies a default time-of-use power template initially. Modify or replace it as needed.

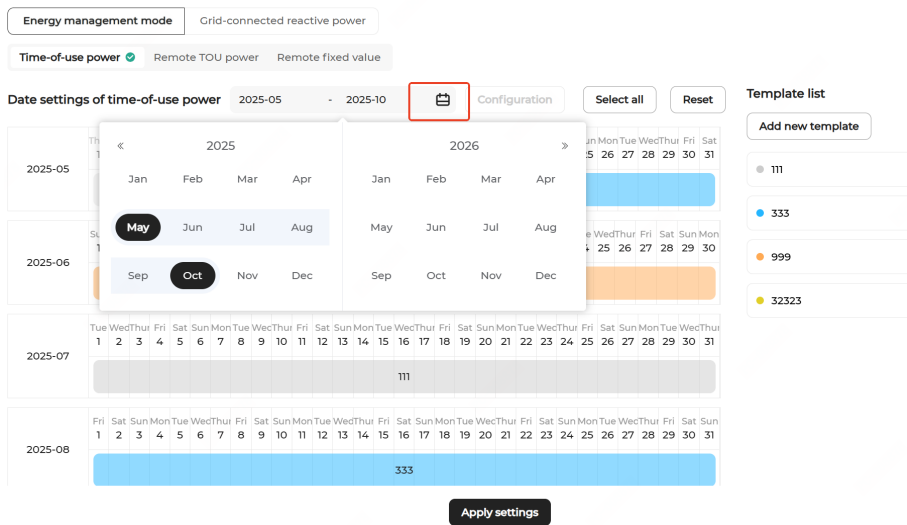

Step 3 Choose an appropriate time-of-use power template to configure the time-of-use power strategy:

- If the same strategy applies to all days in the selected period, select all dates using the **Select all** option, then click **Configuration**. In the pop-up window, select the desired time-of-use power template and click **Confirm**. The configured strategy will apply to all selected days.

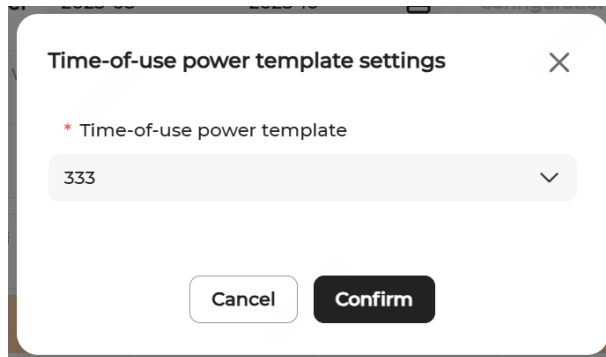

- If different strategies apply to different days (e.g., differentiating working days and non-working days), hover over a specific date, select a single day or a date range, then click **Configuration**. In the pop-up window, select the desired time-of-use power template and click **Confirm**. The configured strategy will apply only to the selected days.

Step 4 (Optional) Delete a time-of-use power strategy. Hover over the configured time block you want to delete, and click the Close icon in the upper right corner of the time block.

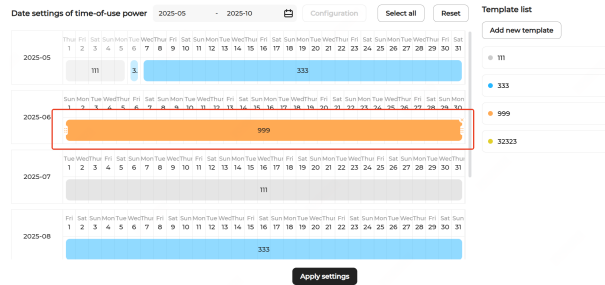

Step 5 (Optional) Reset current template selections to default. Click **Reset** and then click **Confirm**.

Step 6 Click **Apply settings**. In the pop-up window, enter the **Task name** and click **Confirm**.

--End

2.3.13.1.1.5 Remote Time-of-Use Power Management

Third-party scheduling units can allocate and adjust the output power in different time periods based on grid demand and power generation resources to ensure stable grid operation. On the **Remote TOU power** page, users can view power settings for each time period but cannot modify the parameters.

Step 1 Choose **Energy management mode > Remote TOU power**.

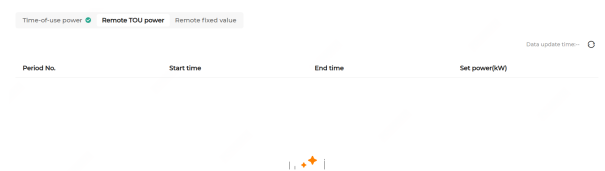

Step 2 View power allocation information for each time period sent by the third-party dispatch unit on this page. Take note of the following items:

- Each row on the page shows the charging or discharging status of the ESS during a specific time period.
- Set power: A positive value indicates that the ESS is discharging, while a negative value indicates that the ESS is charging.

--End

2.3.13.1.1.6 Self-Consumption

The **Self-Consumption** mode maximizes the utilization of PV output and battery energy to power the loads, thus minimizing grid energy consumption. Users can configure specific time periods for **Allow Discharging** and **Force Charging** based on electricity rates to optimize energy costs.

See [3.3.2.1.2.4 Forced Mode](#).

2.3.13.1.1.7 VPP Dispatch

In VPP mode, the system operates according to the feed-in power and battery charging/discharging commands from the VPP provider. The system supports API-based command transmission and control.

Commands are received via the iSolarCloud platform and issued to the EMS300CP controller for execution, enabling ESS control. Refer to [API usage specification](#) for details.

Step 1 Choose **Energy management > Energy management mode > VPP**.

Step 2 Click **Apply settings**. In the pop-up window, enter the **Task name**, then click **Confirm**.

--End

2.3.13.1.1.8 Remote Fixed Value

This function controls the plant to output active power according to the target value remotely set by the third-party dispatch system.

Step 1 Choose **Energy management > Energy management mode > Remote fixed value**.

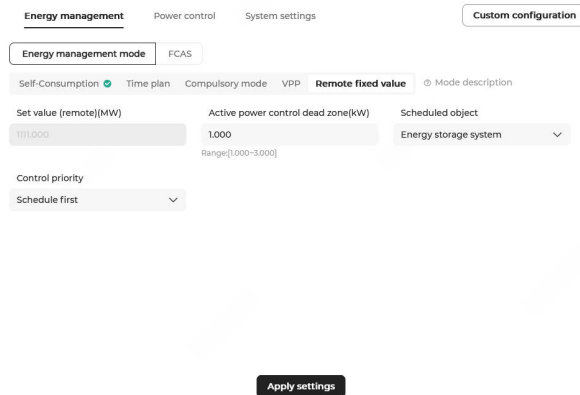

Step 2 Configure the following parameters as needed:

Parameter	Description	Value
Remotely set value (MW)	Displays the active power value remotely set by the third-party dispatch system.	Display only. No configuration is required.
Active power control deadband (kW)	Recommended value: 1% of the rated power. When the change in active power is less than this threshold, the system continues to run at the original power level. It defines the range within which the target active power value can fluctuate. For example, if the target active power at the grid connection point is set to 10 kW, and the deadband is set to 5 kW, then the actual active power may fluctuate between 5 kW and	Range: [0, max (10, 0.03 × ESS rated power)]. 3.000 by default.

Parameter	Description	Value
	15 kW during operation, which is within the acceptable range.	
Control priority	Specify the control priority of EMS300CP when the power command from the third-party dispatch conflicts with the local control strategy.	<ul style="list-style-type: none"> • Local first (default): The local control strategy takes precedence. • Dispatch first: The third-party dispatch command takes precedence.
Dispatched object	This parameter needs to be configured when the Control priority is set to Dispatch first . It defines the closed-loop point for the remotely set value.	<ul style="list-style-type: none"> • Grid connection point: Adjust the power at the grid connection point to the target value. • Energy storage system (default): Adjust the power of the ESS to the target value.

Step 3 Click **Apply settings**. In the pop-up window, enter the **Task name**, then click **Confirm**.
--End

2.3.13.1.1.9 Cloud Scheduling

Step 1 If **Cloud scheduling** is selected, the ESS can receive scheduling commands from the cloud platform.
--End

2.3.13.1.2 Grid-connected Reactive Power

2.3.13.1.2.1 Power Factor Control

Used to adjust the power factor to reduce the power factor adjustment charges.

Step 1 Choose **Energy management > Grid-connected reactive power**.

Step 2 Set **Function enable/disable**.

- **Enable**: Enable the reactive power control function. Proceed to subsequent configurations.
- **Disable**: Disable the reactive power control function.

Step 3 Choose **Power factor control** in **Mode selection**.

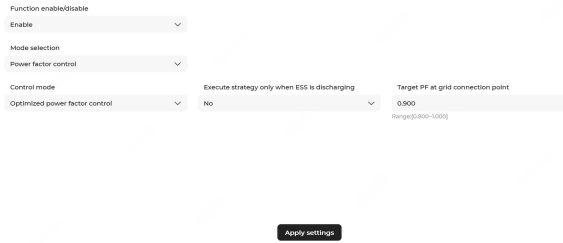

Step 4 Choose a **Control mode**.

- In **Optimized power factor control** mode (default), configure the following parameters:

Parameter	Description
Execute strategy only when ESS is discharging	<ul style="list-style-type: none"> - Yes: When the grid power factor decreases, the power factor control strategy will only be executed during discharging of the ESS. - No: When the grid power factor decreases, the power factor control strategy will be executed during charging, discharging, and zero power output of the ESS.
Power factor target value	<p>Range: 0.800–1.000; 0.900 by default.</p> <p>When the power factor falls below the set value, the system will automatically calculate the reactive power target value based on this target value and the active power at the grid connection point, and coordinate with the PV-ESS system for reactive power regulation.</p>

- **Normal mode:** The power factor can be set with a positive or negative sign, and the following parameters need to be configured.

Parameter	Description
Execute strategy only when ESS is discharging	<ul style="list-style-type: none"> - Yes: When the grid power factor decreases, the power factor control strategy will only be executed during discharging of the ESS. - No: When the grid power factor decreases, the power factor control strategy will be executed during charging, discharging, and zero power output of the ESS.
Power factor target value	<p>Range: -1.000– - 0.800 or 0.800–1.000; 0.900 by default.</p> <p>If the absolute value of the power factor is less than the set target value, the target reactive power value of the grid-connection point can be calculated on the basis of the set target value and the active power value of the grid-connection point, and then the reactive power can be regulated by the ESS and PV system.</p>

Parameter	Description
	<p> When the directions of reactive power and active power are the same, the power factor is positive; when the directions of reactive power and active power are opposite, the power factor is negative.</p>
Power factor control deadband	<p>Define the allowable fluctuation range for the target power factor value. Range: 0.001–0.200; 0.010 by default.</p>

- **Four-quadrant control mode:** This mode supports setting different power factor values for charging and discharging. The following parameters need to be configured:

Parameter	Description
Execute strategy only when ESS is discharging	<ul style="list-style-type: none"> - Yes: When the grid power factor decreases, the power factor control strategy will only be executed during discharging of the ESS. - No: When the grid power factor decreases, the power factor control strategy will be executed during charging, discharging, and zero power output of the ESS.
Charging power factor target value	<p>Range: -1.000– - 0.800 or 0.800–1.000; 0.900 by default. If the absolute value of the charging power factor is less than the set target value, the target reactive power value of the grid-connection point can be calculated on the basis of the set target value and the active power value of the grid-connection point, and then the reactive power can be regulated by the ESS and PV system.</p> <p> When the directions of reactive power and active power are the same, the power factor is positive; when the directions of reactive power and active power are opposite, the power factor is negative.</p>
Discharging power factor target value	<p>Range: -1.000– - 0.800 or 0.800–1.000; 0.900 by default. If the absolute value of the discharging power factor is less than the set target value, the target reactive power value of the grid-connection point can be calculated on the basis of the set target value and the active power value of the grid-connection point, and then the reactive power can be regulated by the ESS and PV system.</p>

Parameter	Description
	<div style="border: 1px solid gray; padding: 5px; display: inline-block;">  <p>When the directions of reactive power and active power are the same, the power factor is positive; when the directions of reactive power and active power are opposite, the power factor is negative.</p> </div>
Power factor control deadband	<p>Define the allowable fluctuation range for the target power factor value.</p> <p>Range: 0.001–0.200; 0.010 by default.</p>

Step 5 Click **Apply settings**. In the pop-up window, enter the **Task name**, set the **Instruction valid period**, and click Confirm.

--End

2.3.13.1.2.2 Remote Fixed Value

This function controls the plant to output reactive power according to the target value remotely set by the third-party dispatch system.

Step 1 Choose **Energy management > Grid-connected reactive power**.

Step 2 Set **Function enable/disable**.

- **Enable:** Enable the reactive power control function. Proceed to subsequent configurations.
- **Disable:** Disable the reactive power control function.

Step 3 Select the **Remote fixed value** mode.

Apply settings

Step 4 Configure the following parameters:

Parameter	Description	Value
Dispatched object	It defines the closed-loop point for the remotely set value.	<ul style="list-style-type: none"> • Grid connection point (default): The remotely set value in reactive power control will be used to perform closed-loop control for the power at the grid connection point.

Parameter	Description	Value
		<ul style="list-style-type: none"> Energy storage system: The remotely set value in reactive power control will be used to perform closed-loop control for the ESS.
Remotely set value (Mvar)	Displays the reactive power value remotely set by the third-party dispatch system.	Display only. No configuration is required.
Control deadband (kvar)	<p>It defines the range within which the target reactive power value can fluctuate.</p> <p>For example, if the target reactive power at the grid connection point is set to 10 kvar, and the deadband is set to 5 kvar, then the actual reactive power may fluctuate between 5 kvar and 15 kvar during operation, which is within the acceptable range.</p>	Range: [0, max (10, $0.03 \times$ ESS rated power)]. 3.000 by default.

Step 5 Click **Apply settings**. In the pop-up window, enter the **Task name**, then click **Confirm**.
--End

2.3.13.1.2.3 Voltage Control

Control the plant's reactive power according to the preset fixed voltage value.



This feature is available on EMS300CP-SV100.001.00.P028 or later.

Step 1 Choose **Energy management > Grid-connected reactive power**.

Function enable/disable
 Enable Disable

Mode selection
 Voltage control

Set value (upper computer)(kV) Range:[0.000-1,000.000]

Control deadband(kV)

Rated grid voltage(kV) Range:[0.000-1,000.000]

Voltage droop coefficient(kvar/kV) Range:[-500,000.000-500,000.000]

Step 2 Set **Function enable/disable**.

- **Enable:** Enable the reactive power control function. Proceed to subsequent configurations.
- **Disable:** Disable the reactive power control function.

Step 3 Select **Voltage control** in **Mode selection**.

Step 4 Configure the following parameters as needed:

Parameter	Description	Value
Setpoint (remote) (kV)	Displays the voltage value remotely set by the third-party dispatch system.	Display only. No configuration is required.
Control deadband (kV)	Defines the allowable fluctuation range for the target voltage value.	Range: [0, 1/5 of Rated grid voltage]. 0.010 by default.
Grid nominal voltage (kV)	Enter the actual rated voltage of the grid.	Range:[0.000,1000.000]. 10.000 by default.
Voltage droop coefficient K	The rate at which the voltage changes with the reactive power. Set this parameter according to grid requirements.	Range:[-500000.000,500000.000]. 30.0 by default.

Step 5 Click **Apply settings**. In the pop-up window, enter the **Task name**, then click **Confirm**.

--End

2.3.13.1.3 Off-Grid Operation

In the event of off-grid startup, if the PV power generation system supplies power to both the ESS devices and the loads, the user can set different PV active power according to different power supply scenarios.



This function applies to off-grid scenarios.

Step 1 Choose **Energy management > Off-grid operation**.

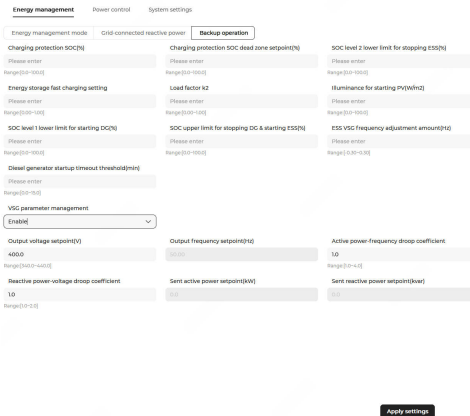

The figure is for reference only. The actual user interface may differ and shall prevail.

Step 2 Complete the following settings:

Parameter	Description	Value
Charging protection SOC (%)	When the maximum SOC of the energy storage unit is greater than or equal to the setpoint, the system will stop charging. In the PV-ESS scenarios, the PV generation power will be limited to achieve zero charging power. When the automatic transfer switch (ATS) triggers the off-grid diesel generator mode, the system will automatically switch to the virtual synchronous generator (VSG) mode.	Default value: 90.0. Range: 0.0–100.0.
SOC upper limit (%)	Displays the SOC upper limit when off-grid. The data is taken from the off-grid setpoint under Power control > SOC protection .	Display only, no need to configure.
Charging protection SOC deadband (%)	It limits the range within which the target charging protection SOC can fluctuate.	Default value: 2.0. Range: 0.0–100.0.

Parameter	Description	Value
SOC for stopping ESS (%)	<p>When the ESS SOC is less than or equal to the setpoint, the system will issue a command to stop the ESS.</p> <div style="border: 1px solid black; padding: 5px; margin-top: 10px;"> <p> When the system is equipped with a meter whose Meter purpose is set to Diesel generator meter and detects a normal operation in the diesel generator, the system will issue a command to close the grid-connected circuit breaker.</p> </div>	Default value: 10.0. Range: 0.0–100.0.
SOC lower limit (%)	Displays the SOC lower limit when off-grid. The data is taken from the off-grid setpoint under Power control > SOC protection .	Display only, no need to configure.
ESS charging power factor	When the maximum SOC of the ESS is less than the charging protection SOC, the setpoint of PV active power = ESS charging power factor × minimum charging power of energy storage units × the number of energy storage units + load factor K2 × load power.	Default value: 0.80. Range: 0.0–1.00.
Load factor K2	When the ESS is fully charged and power is supplied only to the loads, the setpoint of PV active power = load factor K2 × Load power.	Default value: 0.98. Range: 0.0–1.00.
Irradiance for starting PV (W/m²)	When the ESS irradiance is greater than or equal to the setpoint, the system will issue a command to start up the ESS.	Default value: 50.0. Range: 0.0–100.0.

Parameter	Description	Value
	 <p>This parameter is applicable to scenarios where the irradiance is managed via a data logger.</p>	

Step 3 When the plant is connected to a diesel generator, further configure **Diesel generator parameters**.

Parameter	Description	Value
SOC for starting DG	When the ESS SOC is less than or equal to the setpoint, the system will issue a command to start up the diesel generator.	Default value: 25.0. Range: 0.0–100.0.
SOC for stopping DG & starting ESS	When the ESS SOC is greater than or equal to the setpoint, the system will issue a command to stop the diesel generator.	Default value: 80.0. Range: 0.0–100.0.

Step 4 When the plant is connected to chargers, further configure **Charger parameters**.

Parameter	Description	Value
Conventional load power (kW)	Set this value for other electrical equipment and loads in the system, excluding the chargers. If the value is set too small, the power supplied to chargers will be too high, resulting in insufficient power supply. If the value is set too high, the power supplied to chargers will be too low, affecting charging time.	The default value is 10.0. Your setpoint should be greater than 0, but the maximum value cannot exceed the maximum discharge capacity of the ESS.
SOC for stopping charger (%)	When the ESS SOC (calculated as the number	Default value: 50. Range: 0–100.

Parameter	Description	Value
	<p>of available energy storage units × the remaining SOC of a single energy storage unit) falls below the setpoint, the system will stop supplying power to the chargers to meet the power demand of the conventional loads.</p> <p>It is recommended to set this value as follows: (the setpoint of conventional load power × usage time) / total ESS capacity.</p>	
<p>Load meter measurement range</p>	<p>Define the collection range of the load metering meter based on the actual device conditions.</p> <ul style="list-style-type: none"> • Excluding charger: The data collected by the load meter does not include the energy consumption of chargers. • Including charger: The data collected by the load meter includes the energy consumption of chargers. <div style="border: 1px solid gray; padding: 5px; margin-top: 10px;"> <p> This feature is supported in EMS300CP-SV100.001.00.P029 or later.</p> </div>	<p>Excluding charger is selected by default.</p>

Step 5 When the plant is connected to ATS, further configure **ATS parameters**.

Parameter	Description	Value
DG startup timeout (min)	<p>After the digital output (DO) issues a start or stop command to the diesel generator, if the waiting time exceeds this value, it is assumed that the diesel generator has been started or stopped by default.</p> <div data-bbox="585 662 627 705" style="display: inline-block; vertical-align: middle;">  </div> <div data-bbox="649 595 862 784" style="border: 1px solid gray; padding: 5px; display: inline-block; vertical-align: middle;"> <p>When a diesel generator is connected to the plant, this parameter is displayed.</p> </div>	Default value: 5.0. Range: 0–15.0.
Frequency regulation offset for VSG mode (Hz)	<p>When the ATS triggers the off-grid diesel generator mode, the VSG frequency is adjusted to achieve fine control of the ESS charging power. The core goal is to prevent the ESS SOC from continuously declining and causing shutdown, while ensuring that the ESS maintains a low charging power without overloading the diesel generator, under the premise of meeting the load demand.</p> <p>Modify the parameter as follows:</p> <ol style="list-style-type: none"> a. Shut down the system with one click and modify the value with a step size of 0.01–0.02 Hz, for example, 0.02 Hz. 	Default value: 0. Range: -0.30–0.30.

Parameter	Description	Value
	<p>b. Start the system. The parameter will take effect after the ATS off-grid diesel generator mode is activated, or the ATS off-grid VSG mode is activated first, but switched to the ATS off-grid diesel generator mode.</p> <p>c. After starting, if the ESS power meets the requirements for low power charging, no further modification is needed. If not, repeat step a and continue modifying.</p> <div data-bbox="719 936 901 1338" style="border: 1px solid gray; padding: 5px; margin-left: 20px;"> <p>The recommended low power charging is less than or equal to 20 kW. If it affects the user loads, it can be further reduced to 10 kW.</p> </div>	
<p>SOC for ESS shutdown pre-alarm clear (%)</p>	<p>When the ESS SOC is greater than or equal to this setpoint, set the measuring point of ESS shutdown pre-alarm of the ATS to 0.</p>	<p>Default value: 20.0. Range: 0.0–100.0.</p>

Parameter	Description	Value
	<p>i This feature is supported in EMS300CP, whose firmware version is P024 or later.</p>	
SOC for ESS shutdown pre-alarm (%)	<p>When the ESS SOC is less than or equal to this setpoint, set the measuring point ESS shutdown pre-alarm of the ATS to 1.</p> <p>i This feature is supported in EMS300CP, whose firmware version is P024 or later.</p>	<p>Default value: 15.0. Range: 0.0–100.0.</p>

Step 6 Click **Apply settings**. In the pop-up window, enter the **Task name**, then click **Confirm**.
--End

2.3.13.1.4 Fast Frequency Response

Fast frequency response is used to measure the frequency at the grid-connection point in real time and perform auto control accordingly to keep the frequency within a safe range.

Choose **Energy management > Fast-frequency response**.

2.3.13.1.4.1 Primary Frequency Regulation

Step 1 Click **▼** below **Frequency response type**. Select **Primary frequency regulation**.

Step 2 Set **Function enable/disable** and **Segment number**.





The figure is for reference only. The actual user interface may differ.

Step 3 Configure the frequency regulation parameters. The descriptions of the parameters are shown below.

Parameter	Description
f_N	Rated frequency of grid-connection point
$\delta\%$	Frequency regulation coefficient ($\delta\% = -\Delta f(\%) / \Delta P(\%)$)
f_d	Frequency regulation dead zone
P_A	Maximum output active power
P_B	Maximum active power absorbed
α_1	Lower limit of active power limit coefficient
α_2	Upper limit of active power limit coefficient
δ_2^*	Frequency regulation II regulation coefficient
f_{d2}^*	Frequency regulation II dead zone

*Parameters required to be set when Segment number is set to 5.



The active power limit coefficient is the absolute value of the ratio of the active power output increment limit against the rated power of energy storage.

Step 4 Click **Apply settings**. In the pop-up window, enter the **Task name**, and click **Confirm**.
--End

2.3.13.1.4.2 FCAS

Step 1 Click  below **Frequency response type**. Select **FCAS**.

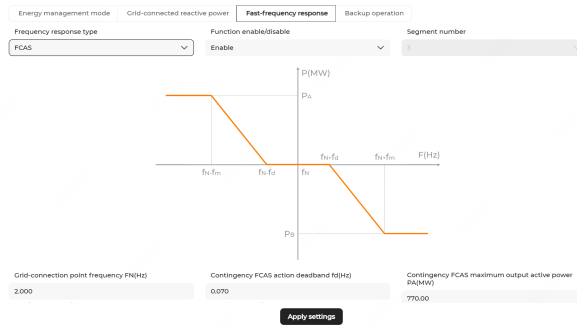

Step 2 Set **Function enable/disable**.

- **Enable:** Enable the function. Proceed to subsequent configurations.
- **Disable:** Disable the function.

Step 3 (Optional) Complete the secondary frequency regulation settings.

Parameter	Description
Secondary frequency regulation lockout	<p>Default value: Disable.</p> <ul style="list-style-type: none"> • Enable: Enable secondary frequency regulation. • Disable: Disable secondary frequency regulation.
Lockout error of secondary frequency regulation	<p>Set this parameter when Secondary frequency regulation lockout is set to Enable. The default value is recommended.</p> <p>This parameter is used for coordinated control of primary and secondary frequency regulation. When the grid frequency deviation is less than the value of this parameter, secondary frequency regulation (i.e., receiving AGC commands) and primary frequency regulation will be combined, regardless of whether they are in the same or opposite directions. When the grid frequency deviation exceeds the value of this parameter, the secondary frequency regulation lockout strategy is executed, and combination will not be performed.</p>

Step 4 Configure the frequency regulation parameters. The descriptions of the parameters are shown below.

Parameter	Description
f_N	Rated frequency of grid-connection point
f_d	Contingency FCAS action deadband
P_A	Contingency FCAS maximum output active power
P_B	Contingency FCAS maximum absorption active power
f_m	Contingency FCAS frequency deviation threshold for full-scale response

Step 5 Click **Apply settings**. In the pop-up window, enter the **Task name**, and click **Confirm**.

--End

2.3.13.1.5 FCAS

FCAS is used to regulate the grid connection frequency of the plant. It responds to grid frequency fluctuations according to set frequency regulation parameters to maintain system stability.

Step 1 Choose **Energy management > FCAS**.

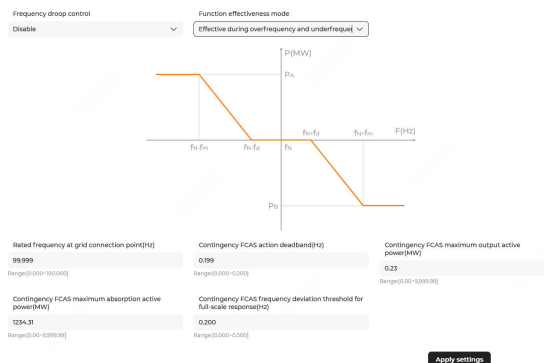

Step 2 Set **Function enable/disable**.

- **Enable:** Enable the function.
- **Disable:** Disable the function.

Step 3 Set the **Function effectiveness mode**.

- **Effective during overfrequency:** The function is effective only during overfrequency.
- **Effective during underfrequency:** The function is effective only during underfrequency.
- **Effective during overfrequency and underfrequency:** Default mode. The function is effective during both overfrequency and underfrequency.



The firmware version of EMS300CP must be P024 or later.

Step 4 Configure the frequency regulation parameters on the right. The descriptions of the parameters are shown below:

Parameter	Description	Value
f_N (Hz)	Rated frequency at grid connection point	Default value: 50.000.
f_d (Hz)	Frequency regulation deadband	Default value: 0.150. When the frequency is within the range of f_N (Rated frequency at the grid connection point) ± 0.150 , the frequency regulation strategy does not respond.
P_A (MW)	Max. output active power	Range: [0, 9999.99]. Default value: 50.00. Set this parameter according to actual conditions.
P_B (MW)	Max. active power absorbed	Range: [0, 9999.99]. Default value: 50.00. Set this parameter according to actual conditions.
f_m (Hz)	Frequency deviation threshold for full-scale response	The critical value that triggers the maximum power output/absorption response. Default value: 0.500.

Step 5 Click **Apply settings**. In the pop-up window, enter the **Task name**, and click **Confirm**.
--End

2.3.13.2 Power Control

2.3.13.2.1 Grid-Connected Power Control

To ensure electrical safety and regulatory compliance, users need to set a proper feed-in power limit based on the requirements of the local grid operator, preventing the feed-in power of the system from exceeding the allowable range. In addition, users can set a power limit for energy purchase based on their capacity demands to prevent energy purchased from the grid exceeding the allowable range.

Step 1 Access the **Power control** page and select **Grid-connected power control**.

Energy purchase control method ⓘ	Power limit for energy purchase	
Purchase energy with limited power	0.0 kW	
	Range: [0.0, 999.999.9]	
Feed-in control method ⓘ	Feed-in control mode	Feed-in power limit
Feed-in power limitation	Total active power control	0.0 kW
		Range: [-999.999.9, 999.999.9]
Third-party power generation systems		
Close		

Step 2 In the **Energy purchase control method** drop-down list, select **No limit**, **Purchase energy with limited power** or **Dynamic power purchase threshold**.

- **No limit:** Indicates no limit on power purchase.
- **Purchase energy with limited power:** Indicates that there is a power limit for purchasing energy from the grid. The **Power limit for energy purchase** must be set. Enter a proper power limit for energy purchase based on the rated current of the main power source device that is connected to the system or other maximum power demand requirements.
- **Dynamic power purchase threshold:** This control method is applicable to scenarios where the full plant is controlled based on purchase energy with limited power, while the power purchase threshold in certain areas within the plant requires dynamic control. The **Power limit for energy purchase** must be set to achieve multi-zone flexible control.



The firmware version of EMS300CP must be P025 or later.

Example scenario:

- Full plant setting: **Power limit for energy purchase** is set to 866 kW, monitored via the meter M1 (this meter does not need to be connected to the system).
- Branch 1: Load-only circuit (Load1), equipped with the meter M2. Set the **Meter purpose** of M2 to **Dynamic demand threshold**. It is recommended to set the **Access type** to **Load electricity meter**. For detailed instruction, see [Edit Meter](#).
- Branch 2: Integrated PV-ESS-Load branch, equipped with the meter M3. It is recommended to set the **Access type** for the meter M3 to **PoC meter**. Self-consumption, zero power feeding into the grid, and demand control must be available. The dynamic demand threshold = 866 - real-time power purchase monitored by M2.

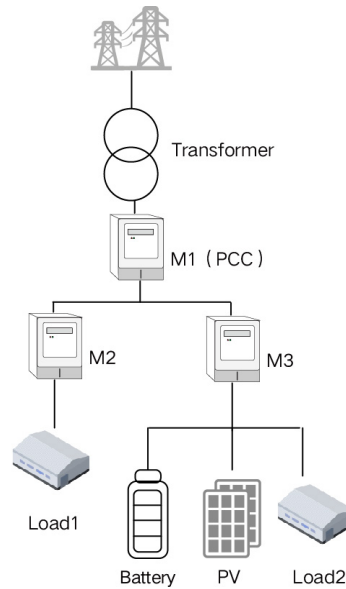

- Step 3** In the **Feed-in control method** drop-down list, select **No limit** or **Feed-in power limitation**.
- Step 4** If **Feed-in power limitation** is selected, you need to select a unit for the target feed-in power. Options include **kW** and **%**.
- Step 5** When the unit **kW** is selected, set a proper feed-in power value based on local regulatory requirements.
- Step 6** When the unit **%** is selected, select a basis for limiting the grid-connected power from the **Feed-in power limit ratio calculation basis** drop-down list.

Feed-in power limit = Feed-in power limit ratio × (Feed-in power limit ratio calculation basis + Rated power of third-party power generation system)

- **Nominal power:** The dispatched value is calculated based on the rated power of the energy storage unit that is connected.
- **Installed PV power:** The dispatched value is calculated based on the installed PV power of the inverter that is connected. Enter the **Total installed power of modules** based on the actual plant conditions.

- Step 7** Set the **Feed-in control mode**.
- Total active power control: Default option. The system determines whether to trigger the control strategy based on the total active power value.
 - Per-phase active power control: The system determines whether to trigger the control strategy based on the active power value of each phase.

i A three-phase four-wire meter is required to measure the A/B/C phase power.

i The firmware version of EMS300CP must be P024 or later.

- Step 8** In the **Third-party power generation systems** drop-down list, select **Open** or **Close**.



When third-party power generation equipment is present in the plant but not connected to the EMS300CP, this parameter must be set.

Step 9 If **Open** is selected in **Third-party power generation systems**, users can specify the rated power in **Rated power of third-party power generation system (kW)**. Range: 0–99999999. Unit: kW. The default value is 0.

Step 10 Click **Apply settings**. In the pop-up window, enter the **Task name**, set the **Instruction valid period**, and click Confirm.

--End

2.3.13.2.2 Demand Control

After you set the maximum demand threshold, the system will intelligently regulate the charging and discharging behavior of energy storage devices to ensure that the real-time power at the grid-connection point remains below this threshold. This effectively reduces demand charges.

Step 1 Choose **Power control > Demand control**.

Step 2 Set **Function enable/disable**.

- **Enable:** Enable the demand control function. Proceed to subsequent configurations.
- **Disable:** Disable the demand control function.

Step 3 Select an option in **Select strategy**. Options include **Max. contract demand**, **Max. actual demand**, and **Dynamic demand**.

- **Max. contract demand:** The combination of ESS charging and load consumption may cause the demand value to increase. However, the EMS can reduce the charging power of the ESS based on the set static demand (**Max. contract demand**) value, to ensure that the static demand is not exceeded due to planned charging of the ESS (e.g., when the time-of-use power control strategy is enabled). After this strategy is selected, set the **Max. allowable demand (kW)** value as the **Max. contract demand**. Range: 0.0–9999999.0 kW. Default value: **0**.
- **Max. allowable demand:** The EMS collects the real-time maximum demand value from the PCC meter calculates it internally. (The value is dynamic and refreshed whenever a

new historical maximum value is reached during the current month.) The EMS controls the ESS to reduce the charging power, ensuring that the maximum demand is not exceeded in planned charging of the ESS.

If you select this mode, configure the following parameters:

- **Lower limit for demand control (kW):** If the meter's real-time demand value falls below the set **Lower limit for demand control**, the set **Lower limit for demand control** will be adopted as the maximum allowable demand. Range: 0.0-9999999.0 kW. Default value: **100 kW**.
- **Max. demand data source:** Specify the source of the maximum demand data. Options include **Meter** and **EMS300CP**.
 - **Meter** (default): Use data from the PCC meter directly. If the meter cannot upload maximum demand data, the **Lower limit for demand control** will be used automatically.
 - **EMS300CP:** Use the value calculated by EMS300CP.
- **Dynamic demand:** This strategy is applicable to scenarios where the full plant is controlled based on the maximum contract demand, while the demand thresholds for certain internal power consumption areas require dynamic control. The system can set dynamic target values to achieve flexible regional control.



The firmware version of EMS300CP must be P025 or later.

After this strategy is selected, set the **Max. allowable demand (kW)** value as the power purchase threshold of the full plant. Range: 0.0–9999999.0 kW. Default value: **0**.

Example:

- Plant-level settings: Set the **Max. allowable demand** to 866 kW, and use meter M1 for monitoring. (This meter does not need to be connected to the system.)
- Branch 1: Load-only circuit (Load1), equipped with meter M2. Set the **Meter purpose** of M2 to **Dynamic demand threshold**. It is recommended to set the **Access type** to **Load electricity meter**. For detailed instructions.
- Branch 2: Integrated PV-ESS-Load branch, equipped with meter M3. It is recommended to set the **Access type** to **PoC meter**. This branch is required to implement self-consumption, zero export, and demand control. The **Dynamic demand threshold** = 866 - Real-time energy purchasing power monitored by M2.

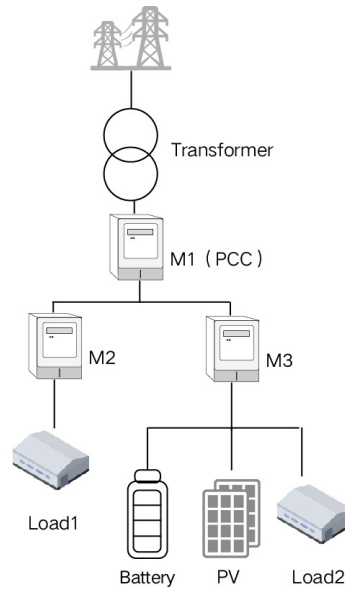

Step 4 Set **Allow ESS to discharge or not**.

- **Yes:** The ESS is allowed to discharge to supply the load in addition to reducing the charging power in demand control.
- **No:** The ESS is allowed to reduce the charging power but not to discharge in demand control.



If **No** is selected and the ESS is discharging, the enabled **demand control** strategy will not take effect.

Step 5 Click **Apply settings**. In the pop-up window, enter the **Task name**, then click **Confirm**.

--End

2.3.13.2.3 Zero Export

The zero export strategy prevents the PV-ESS system from feeding power into the grid. If the discharging power of the PV-ESS system exceeds the load power, the system will automatically reduce the PV output, lower the discharging power, or charge the batteries to prevent power back-feeding.

Step 1 Choose **Power control > Zero export**.

Step 2 Click  to set **Function enable/disable**.

- **Enable:** Enable the zero export function. Configure the following parameters:

Function enable/disable

Enable ▼

Target power at grid connection point(kW) ?

0.0

Range:[-9,999.9~9,999.9]

Allow ESS charging during reverse power flow

Enable ▼



Allow PV power feed-in during reverse power flow

Commissioning ▼

Feed-in control mode

Total active power control ▼

Parameter	Description
Target power at grid connection point (kW)	<p>The default value is 0.0. It is recommended to set this value to -1% to -2% of the rated active power of the ESS.</p> <p>When the actual power at the grid connection point > the set target value, the system will automatically reduce the ESS discharge or PV output.</p>
Allow ESS charging during reverse power flow	<ul style="list-style-type: none"> - Enable: If the ESS discharging power is reduced to zero and power back-feeding persists, the ESS switches to charging mode to absorb PV output. - Disable (default): If the ESS discharging power is reduced to zero and power back-feeding persists, the ESS maintains zero power output.
Allow PV power feed-in during reverse power flow	<ul style="list-style-type: none"> - Enable (default): When power back-feeding occurs, PV power feed-in is allowed. - Disable: When power back-feeding occurs, PV output power is reduced to prevent power feed-in. <div style="border: 1px solid gray; padding: 5px; margin-top: 10px;"> <p> This feature is available on EMS300CP-SV100.001.00.P027 or later.</p> </div>
Feed-in control mode	<ul style="list-style-type: none"> - Total active power control: Default option. The system determines whether to trigger the control strategy based on the total active power value. - Per-phase active power control: The system determines whether to trigger the control strategy based on the active power value of each phase.

Parameter	Description
	<p> A three-phase four-wire meter is required to measure the A/B/C phase power.</p> <p> This feature is available on EMS300CP-SV100.001.00.P024 or later.</p>

- **Disable:** Disable the zero export function.

Step 3 Click **Apply settings**. In the pop-up window, enter the **Task name**, then click **Confirm**.

--End

2.3.13.2.4 DI Power Regulation

This function regulates the inverter output power based on the external emergency stop signals.

Emergency Stop Modes

Mode	Description
Close	Emergency stop control is disabled.
Stop inverter	When emergency stop is triggered, the inverter enters the stop state and the ESS enters the standby state.
Stop inverter and trip battery	When triggered, the inverter stops exporting power to the grid, and the battery ceases all interactions with the inverter or grid, neither charging nor discharging. The inverter enters the stop state, and the ESS enters the standby state.

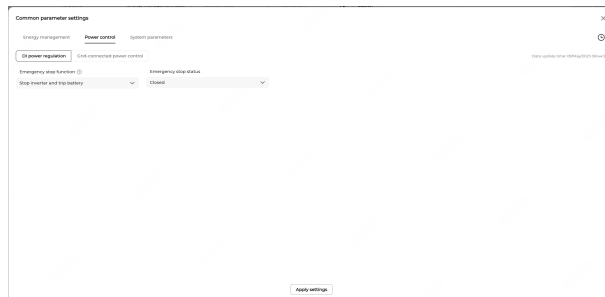

Step 1 Navigate to the **DI power regulation** page.

Step 2 In the **Emergency stop function** drop-down list, select **Close** to disable the function or choose a desired emergency stop mode to enable it.

Step 3 If **Stop inverter** or **Stop inverter and trip battery** is selected, select a trigger condition from the **Emergency stop status** drop-down list.

- **Disconnect:** Emergency stop will be triggered when DI opens.
- **Closed:** Emergency stop will be triggered when DI closes.

Step 4 Click **Apply settings**.

--End

2.3.13.2.5 Overload Protection

Overload protection is used to regulate the charging power of the ESS, so as to ensure the power of the transformer at the grid-connection point does not exceed the rated capacity, thus preventing overload damage.

Step 1 Choose **Power control > Overload protection**.

Function enable/disable

Enable ▼

Transformer capacity(kVA)

90

Range:[0~999,999]

Active power conversion coefficient

1.00

Range:[0.00~1.00]

Dynamic capacity expansion

Open ▼



Overload protection for parallel transformers

Disable ▼

Step 2 Click ▼ to set **Function enable/disable**.

- **Enable:** Enable the overload protection function. Configure the following parameters:

Parameters	Description
Transformer capacity (kVA)	<p>The capacity of the transformer at the grid-connection point. Set this parameter based on the actual situation.</p> <div style="border: 1px solid gray; padding: 5px; margin-top: 10px;"> <p> This parameter is only configurable when the Overload protection for parallel transformers is set to Disable.</p> </div>

Parameters	Description
Active power conversion coefficient	<p>The default value is 1, and the value ranges from 0 to 1. Protection trigger threshold = Transformer capacity × Active power conversion coefficient (Protection is enabled when the transformer-side power is greater than or equal to the threshold)</p> <div data-bbox="683 437 1226 550" style="border: 1px solid gray; padding: 5px;">  This parameter is only configurable when the Overload protection for parallel transformers is set to Disable. </div>
Dynamic capacity expansion	<ul style="list-style-type: none"> - Enable: Prioritize reducing the ESS charging power during overload. If it is reduced to 0 and still overloaded, the ESS will start discharging. - Disable: Only reduce the ESS charging power during overload (ESS discharge is prohibited).
Overload protection for parallel transformers	<p>When multiple overload monitoring meters are connected to the system and overload protection is required for multiple parallel transformers, the Overload protection for parallel transformers can be enabled, and the following parameters can be configured:</p> <ul style="list-style-type: none"> - Transformer capacity (kVA): Set the capacity value of the transformer connected to the current overload monitoring meter. - Impedance voltage (%): Set the impedance voltage percentage of the current transformer. - Active power conversion coefficient: Default value: 1. Range: 0–1. <div data-bbox="719 1236 1226 1319" style="border: 1px solid gray; padding: 5px;">  Set to 0 to indicate that the transformer is excluded from overload protection. </div> <ul style="list-style-type: none"> - DI port: Connect an external DI signal. If the circuit breaker connected to this DI opens, this transformer will be excluded from overload protection. <div data-bbox="719 1456 1226 1569" style="border: 1px solid gray; padding: 5px;">  The corresponding DI port point should be configured as parallel transformer circuit breaker closing feedback. </div> <ul style="list-style-type: none"> - Remarks: Display the configuration remarks for the DI port.

- If it is set to **Disable**, the overload protection function is turned off.

Step 3 Click **Apply settings**. In the pop-up window, enter the **Task name**, then click **Confirm**.

--End

2.3.13.2.6 Power Backup

Power backup is used to protect the charge level of the ESS, so that the ESS operates within the set SOC range when connected to the grid, and some energy is reserved to supply the loads in the event of a grid outage.

Step 1 Choose **Power control > Power backup**.

Step 2 Click to set **Function enable/disable**.

- **Enable:** Enable the power backup function. Configure the following parameters:

Parameter	Description
Power backup lower SOC threshold (%)	When the ESS SOC \leq the threshold, the ESS is not allowed to discharge. Default value: 50.0. Range: 0.0–100.0.
Recharging lower SOC threshold (%)	When the ESS SOC \leq the threshold, the system begins recharging at the configured Recharging power . Recharging stops when the ESS SOC \geq the Power backup lower SOC threshold . Default value: 30.0. Range: 0.0–100.0.
Recharging power (kW)	When the ESS SOC \leq the Recharging lower SOC threshold , the ESS will be charged at this specified power. Default value: 30.0. Set this parameter according to actual conditions.
K value when prioritizing ESS charge	When the ESS SOC $<$ the SOC lower limit level 1 protection threshold, if a minimum charging power is set for the ESS (for example, 0.10), the system allocates 10% of the ESS rated active power from the allocable power for charging. Default value: 0.00. Range: 0.00–1.00.

Parameter	Description
-----------	-------------



This parameter takes effect only when chargers are connected to the system.



SOC in the table refers to the percentage of the current battery power to the total capacity of the battery, namely, the actual available battery power.

- **Disable:** Disable the power backup function.

Step 3 Click **Apply settings**. In the pop-up window, enter the **Task name**, then click **Confirm**.

--End

2.3.13.2.7 SOC Protection

To ensure the safe and efficient operation of the ESS, you can configure the SOC protection thresholds to keep the system strictly within the specified SOC range during grid-connected operation.

Step 1 Choose **Power control > SOC protection**.

SOC balancing
Enable

Energy storage unit SOC parameter synchronization
Enable

Grid-connected

SOC upper limit(%) 95.0 Range:[0.0-100.0]	SOC lower limit(%) 5.0 Range:[0.0-100.0]	SOC upper limit level 2 protection(%) 95.0 Range:[0.0-100.0]
SOC upper limit level 2 recovery(%) 94.0 Range:[0.0-100.0]	SOC upper limit level 1 protection(%) 95.0 Range:[0.0-100.0]	SOC upper limit level 1 recovery(%) 92.0 Range:[0.0-100.0]
SOC lower limit level 1 recovery(%) 62.0 Range:[0.0-100.0]	SOC lower limit level 1 protection(%) 60.0 Range:[0.0-100.0]	SOC lower limit level 2 recovery(%) 7.0 Range:[0.0-100.0]
SOC lower limit level 2 protection(%) 5.0 Range:[0.0-100.0]	Active recharge start SOC(%) 3.0 Range:[0.0-100.0]	

Off-grid

SOC upper limit(%) 95.0 Range:[3.0-97.0]	SOC lower limit(%) 5.0 Range:[3.0-97.0]	SOC upper limit level 2 protection(%) 95.0 Range:[3.0-97.0]
SOC upper limit level 2 recovery(%) 94.0 Range:[3.0-97.0]	SOC upper limit level 1 protection(%) 95.0 Range:[3.0-97.0]	SOC upper limit level 1 recovery(%) 92.0 Range:[3.0-97.0]
SOC lower limit level 1 recovery(%)	SOC lower limit level 1 protection(%)	SOC lower limit level 2 recovery(%)

Apply settings

Step 2 Click in **SOC balancing**.

- **Enable:** Enable the SOC balancing function. The system distributes power based on the SOC of each energy storage unit to keep the SOC across all energy storage cabinets at similar levels. At the individual energy storage cabinet level, SOC balancing is implemented by the LC.
- **Disable:** Disable the SOC balancing function.

Step 3 Configure the SOC balancing strategy in **Grid-connected** and **Off-grid** modes, respectively.

Step 4 Configure the following parameters as needed:

Parameter	Description	Range
SOC upper limit (%)	<p>When the ESS SOC \geq the threshold and the system is in charging state, the system sends a zero-power command to the LC.</p> <p>Default value: 95.0%. The threshold must meet the following constraints:</p> <ul style="list-style-type: none"> - SOC upper limit (%) \geq SOC lower limit (%) + 7; - When Energy storage unit SOC parameter sync is enabled, the threshold must also satisfy: SOC upper limit (%) \leq SOC upper limit level 2 protection (%). 	<ul style="list-style-type: none"> - Grid-connected mode: [0.0, 100.0]. - Off-grid mode: Vary by model. <ul style="list-style-type: none"> • ST200CS and ST255CS: [3.0, 97.0]. • ST835CS: [5.0, 95.0]. • ST500CP and others: [0.0, 100.0].
SOC lower limit (%)	<p>When the ESS SOC \leq the threshold and the system is in discharging state, the system sends a zero-power command to the LC.</p> <p>Default value: 5.0%. The threshold must meet the following constraints:</p> <ul style="list-style-type: none"> - SOC lower limit (%) \leq SOC upper limit (%) - 7; - When Energy storage unit SOC parameter sync is enabled, the threshold must also satisfy: SOC lower limit (%) \geq SOC lower limit level 2 protection (%). 	

Step 5 Setting **Energy storage unit SOC parameter sync**.

- **Enable:** The system will transmit the configured thresholds to the LC, which then implements SOC protection.

Parameter	Description
SOC upper limit level 2 protection (%)	<p>When the ESS SOC \geq the threshold, the ESS is prohibited from charging.</p> <p>Default value: 95.0%. The threshold must meet the following constraints:</p> <ul style="list-style-type: none"> - SOC upper limit level 2 protection (%) \geq SOC upper limit (%); - SOC upper limit level 2 protection (%) $>$ SOC upper limit level 2 recovery (%); - SOC upper limit level 2 protection (%) \geq SOC upper limit level 1 protection (%).
SOC upper limit level 2 recovery (%)	<p>When the ESS SOC \leq the threshold, the ESS resumes charging.</p> <p>Default value: 94.0%. The threshold must meet the following constraints:</p> <ul style="list-style-type: none"> - SOC upper limit level 2 recovery (%) \geq SOC upper limit level 1 recovery (%); - SOC upper limit level 2 recovery (%) $<$ SOC upper limit level 2 protection (%);
SOC upper limit level 1 protection (%)	<p>When the ESS SOC \geq the threshold, the system sends a notification.</p> <p>Default value: 95.0%. The threshold must meet the following constraints:</p> <ul style="list-style-type: none"> - SOC upper limit level 1 protection (%) $>$ SOC upper limit level 1 recovery (%); - SOC upper limit level 1 protection (%) \leq SOC upper limit level 2 protection (%).
SOC upper limit level 1 recovery (%)	<p>Default value: 92.0%. The threshold must meet the following constraints:</p> <ul style="list-style-type: none"> - SOC upper limit level 1 recovery (%) $>$ SOC lower limit level 1 recovery (%); - SOC upper limit level 1 recovery (%) $<$ SOC upper limit level 1 protection (%); - SOC upper limit level 1 recovery (%) \leq SOC upper limit level 2 recovery (%).
SOC lower limit level 1 recovery (%)	<p>When the ESS SOC \geq the threshold, the ESS resumes discharging.</p> <p>Default value: 62.0%. The threshold must meet the following constraints:</p> <ul style="list-style-type: none"> - SOC lower limit level 1 recovery (%) $>$ SOC lower limit level 1 protection (%);

Parameter	Description
	<ul style="list-style-type: none"> - SOC lower limit level 1 recovery (%) < SOC upper limit level 1 recovery (%).
SOC lower limit level 1 protection (%)	<p>When the ESS SOC \leq the threshold, the system sends a notification.</p> <p>Default value: 60.0%. The threshold must meet the following constraints:</p> <ul style="list-style-type: none"> - SOC lower limit level 1 protection (%) \geq SOC lower limit level 2 protection (%); - SOC lower limit level 1 protection (%) < SOC lower limit level 1 recovery (%).
SOC lower limit level 2 recovery (%)	<p>When the ESS SOC \geq the threshold and the system goes back to the lower level 1 protection status, the system is prohibited from discharging.</p> <p>Default value: 7.0%. The threshold must meet the following constraints:</p> <ul style="list-style-type: none"> - SOC lower limit level 2 recovery (%) > SOC lower limit level 2 protection (%); - SOC lower limit level 2 recovery (%) \leq SOC lower limit level 1 recovery (%).
SOC lower limit level 2 protection (%)	<p>When the ESS SOC \leq the threshold, the ESS is prohibited from discharging.</p> <p>Default value: 5.0%. The threshold must meet the following constraints:</p> <ul style="list-style-type: none"> - SOC lower limit level 2 protection (%) \leq SOC lower limit (%); - SOC lower limit level 2 protection (%) < SOC lower limit level 2 recovery (%); - SOC lower limit level 2 protection (%) \leq SOC lower limit level 1 protection (%).
Active recharge start SOC (%)	<p>When the ESS SOC \leq the threshold, the system will trigger active recharging. Default value: 3.0%. This setting can only be configured in grid-connected mode. The configuration must comply with the model of the connected ESS and meet the following constraints:</p> <ul style="list-style-type: none"> - For ST200CS, ST255CS, ST510CS, and ST835CS models: Active recharge start SOC (%) must be \leq 5 and less than SOC lower limit level 2 protection (%), or can be set directly to 0. - For PT2.0UD and PT2.0HX models: Active recharge start SOC (%) must be \geq 0 and less than SOC lower

Parameter	Description
	limit level 2 protection (%), or can be set directly to 0.

i The valid range differs between grid-connected and off-grid modes:

- Grid-connected mode: [0.0, 100.0].
- Off-grid mode: Vary by model.
 - ST200CS and ST255CS: [3.0, 97.0].
 - ST835CS: [5.0, 95.0].
 - ST500CP and others: [0.0, 100.0].

The relationship between the configured SOC parameters of the ESS and the actual ESS SOC under the SOC protection strategy is shown in the following figure:

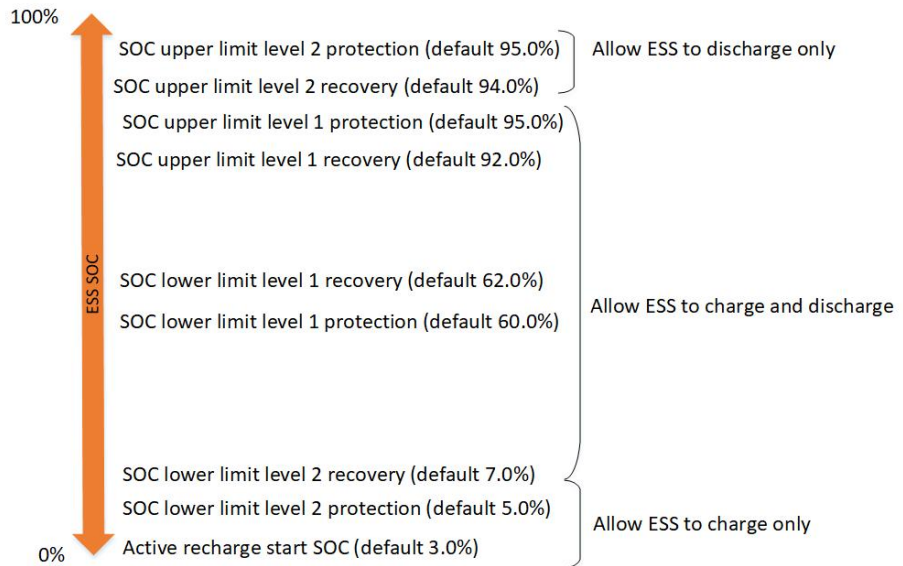

- **Disable:** In grid-connected operation, the system will convert the configured **SOC upper limit (%)** and **SOC lower limit (%)** into synchronized parameters for the energy storage unit and send them to the LC, which then implements SOC protection.

Step 6 Click **Apply settings**. In the pop-up window, enter the **Task name**, then click **Confirm**.

--End

2.3.13.2.8 Anomaly Handling

This function is applicable to automatically executing preset anomaly handling when there is a communication anomaly in Third-party dispatch, LC, or LoggerUpper devices to ensure the stable operation of the system.

Step 1 Choose **Power control > Anomaly handling**.

	Communication interruption control	Communication anomaly time (ms)	Communication anomaly counting period (s)	Communication anomaly count	Anomaly handling method	Control parameters
Third-party dispatch	Enable	600 Range [200-1200]	60 Range [1-6000]	2 Range [1-10]	Retain current	5
LC	Enable	100 Range [200-1200]	60 Range [1-6000]	2 Range [1-10]	Zero power	60 Range [0-600]
Logger/pper	Enable	600 Range [200-1200]	60 Range [1-6000]	2 Range [1-10]	Zero power	60 Range [0-600]

Apply settings

Step 2 Configure the following anomaly check settings as needed. If an anomaly occurs, the system will operate according to the configured **Anomaly handling method**.

Parameters	Description
------------	-------------

Communication interruption control	<ul style="list-style-type: none"> Enable: Enable anomaly check for the device. Disable: Disable anomaly check for the device.
------------------------------------	--

Communication anomaly counting period (s)	Anomaly handling can be triggered in the following two ways (these LC parameters cannot be configured for LC):
---	--

Communication anomaly time (ms)	<ul style="list-style-type: none"> When a single communication anomaly lasts for a period longer than the set Communication anomaly counting period (s), the system triggers anomaly handling. When the duration of a communication anomaly exceeds the set Communication anomaly time (ms), the system records a communication anomaly event. If the number of communication anomalies occurring within the set Communication anomaly counting period (s) reaches the set Communication anomaly count, the system triggers anomaly handling.
---------------------------------	---

Communication anomaly count	
-----------------------------	--



The Communication anomaly counting period (s), Communication anomaly time (ms), and Communication anomaly count for third-party dispatch devices can be modified remotely.

Anomaly handling method	<p>The available options for Anomaly handling method vary by device type.</p> <ul style="list-style-type: none"> For Third-party dispatch, Retain current value, Zero power output, Full-plant shutdown and History energy management mode are supported.
-------------------------	---

Parameters	Description
	<div style="border: 1px solid #ccc; padding: 5px; margin-bottom: 10px;">  In a cascading scenario, the slave device is not allowed to set the History energy management mode. </div> <ul style="list-style-type: none"> • For LC, Zero power output is supported. • For LoggerUpper, Retain current value, Zero power output, and Full-plant shutdown are supported.
Control parameter (s)	<p>Only when the Anomaly handling method is set to Zero power output does it need to be configured, indicating the time required for the system to ramp down from the original operating power to zero. Default value: 60. Range: [0, 600].</p>

Step 3 Click **Apply settings**. In the pop-up window, enter the **Task name**, then click **Confirm**.
--End

2.3.13.3 System Settings

Choose **Strategy configuration > System settings**.

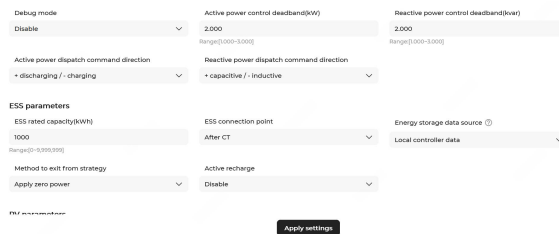

2.3.13.3.1 Plant Parameters

Step 1 Choose **System settings > Plant parameters**.



Step 2 Configure the following parameters:

Parameter	Description
Debug mode	<ul style="list-style-type: none"> • Enable: Enable the debug mode. If the debug mode is enabled, the power control command will not be sent to the DC/AC power converter unit (PCS on the interface) or PV inverter. • Disable(default): Disable the debug mode.
Active power control deadband (kW)	<p>Set this parameter based on the actual power of the plant. It is recommended to set this parameter to 1% of the rated power.</p>

Parameter	Description
	<p>It defines the range within which the target active power value can fluctuate. For example, if the target active power at the grid connection point is set to 10 kW, and the deadband is set to 5 kW, then the actual active power may fluctuate between 5 kW and 15 kW during operation, which is within the acceptable range.</p> <p>Range: [0, max (10, 0.03 × ESS rated power)]. 3.000 by default.</p>
Reactive power control deadband (kvar)	<p>Set this parameter based on the actual power of the plant. It is recommended to set this parameter to 1% of the rated power.</p> <p>It defines the range within which the target reactive power value can fluctuate. For example, if the target reactive power at the grid connection point is set to 10 kvar, and the deadband is set to 5 kvar, then the actual reactive power may fluctuate between 5 kvar and 15 kvar during operation, which is within the acceptable range.</p> <p>Range: [0, max (10, 0.03 × ESS rated power)]. 3.000 by default.</p>
Active power dispatch command direction	<p>The default direction of the active power dispatch command is set to + discharging / - charging. When the direction of the on-site dispatch command is reversed, set it to + charging / - discharging.</p> <div style="border: 1px solid gray; padding: 5px; margin-top: 10px;">  The firmware version of EMS300CP must be P025 or later. </div>
Reactive power dispatch command direction	<p>The default direction of the reactive power dispatch command is set to + capacitive / - inductive. When the direction of the on-site dispatch command is reversed, set it to + inductive / - capacitive.</p> <div style="border: 1px solid gray; padding: 5px; margin-top: 10px;">  The firmware version of EMS300CP must be P025 or later. </div>
ESS rated capacity (kWh)	220 by default. Set this parameter according to actual conditions.
ESS connection point	After CT by default.
Energy storage data source	<ul style="list-style-type: none"> Meter data: Select this option when the meter type is ESS electricity meter. In this case, the EMS collects

Parameter	Description
	<p>ESS charge/discharge data from the ESS electricity meter.</p> <ul style="list-style-type: none"> Local controller data(default): The EMS collects ESS charge/discharge data from the LC.
Method to exit from strategy	<ul style="list-style-type: none"> Retain current value (default): After the strategy is disabled, the ESS continues operating at the original power. Apply zero power: After the strategy is disabled, a zero power command is immediately issued to the ESS.
Active recharge	<ul style="list-style-type: none"> Enable (default): Allows manual enabling of active recharge for the ESS. The setting takes effect once per activation. Disable: Allows manual disabling of active recharge for the ESS. The setting takes effect once per activation. <div style="border: 1px solid black; padding: 5px; margin-top: 10px;">  The firmware version of EMS300CP must be P024 or later. </div>
PV installed capacity (MWp)⁽¹⁾	The actual PV installed capacity of the plant.
PV connection point⁽¹⁾	<p>After CT by default.</p> <p>A third-party PV device must be connected after CT.</p>
Optimization percentage (%)⁽¹⁾	<p>PV-ESS power optimization step = PV rated power × Optimization percentage</p>
Select power distribution strategy⁽²⁾	<p>Options include:</p> <ul style="list-style-type: none"> Evenly distributed: Allocate charging power evenly according to the quantity of electric vehicles (EVs) and grid power limits. First come first charged: Based on charging sequence and grid power limits, allocate power according to EV needs, prioritizing earlier-sequence EVs for quicker charging. Disable(default): No power distribution strategy is enabled.

(1) This parameter is displayed only when PV equipment are connected to the plant.

(2) This parameter is displayed only when chargers are connected to the plant.

Step 3 Click **Apply settings**. In the pop-up window, enter the **Task name**, then click **Confirm**.

--End

2.3.13.3.2 On/Off-Grid Startup

Users can configure the startup settings for the devices and start or stop the devices in the plant in one click.

The configuration page of grid-connected/off-grid startup is shown below.

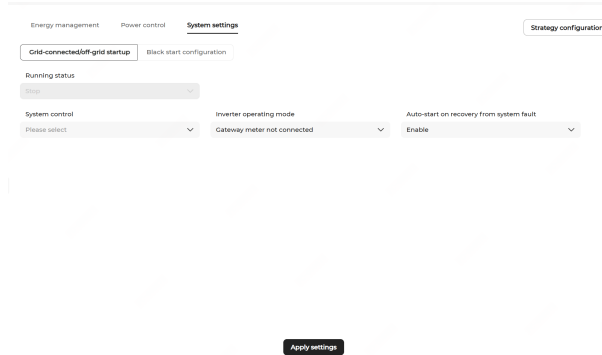

Configure Startup Parameters

Step 1 Choose **System settings > On/off-grid startup**.

Step 2 Select a startup method from the **Startup method** drop-down list.

- When no ATS is connected, the **Startup method** can be set to **Off-grid startup**, **Grid-connected startup** and **Shutdown**
 - Off-grid startup

When the device is in the off-grid state, select **Off-grid startup** to start all the PV and ESS devices in the plant. After a successful startup, the **Running status** will show **Off-grid**.

Configure the black start parameters before proceeding with the startup. Choose **System settings > Black start configuration**. The descriptions of the parameters are shown below.

Parameters	Description
Black start SOC threshold	Default value: 46. Range: 0–100.
Min. units for system operation	Number of units with the minimum SOC. Default value: 1. Range: 0–20.
Load rated power	Set this parameter according to actual conditions. Range: 0–99999.9.
Startup mode	Select a mode based on your actual needs. The supported scenarios of each model for different modes are as follows: <ul style="list-style-type: none"> • ST129CP: When one unit is connected, VSG mode or off-grid mode can be selected; when

Parameters	Description
	<p>multiple units are connected, only off-grid mode is supported.</p> <ul style="list-style-type: none"> ST500CP/ST200CS/ST255CS/ST510CS: When one unit is connected, VSG mode or off-grid mode can be selected; when multiple units are connected, only VSG mode is supported. ST835CS: When one unit is connected, only off-grid mode is supported; when multiple units are connected, only VSG mode is supported.
System waiting time (s)	Default value: 60. Range: 0–100.
System timeout (s)	Default value: 200. Range: 0–0,240.

- Grid-connected startup

When the device is in the grid-connected state, select **Grid-connected startup** to start all the PV and ESS devices in the plant. After a successful startup, the **Running status** will show “Grid-connected”.



At least one LC is needed to start the system. The system starts the local controller first, and then the PV.

- Shutdown

The system sends shutdown commands to the PV and ESS devices in the system. After the shutdown is successful, their **Operating status** will be displayed as **Shutdown**.

• When ATSS are connected to the system, the following options are available for **Startup method**:

- ATS grid-connected startup: Ensure that the diesel generator circuit breaker QF2 is in the open state. Switch on the grid connection circuit breaker QF1 manually. Then, apply this startup method.
- ATS off-grid startup (VSG mode): Ensure that the grid connection circuit breaker QF1 and diesel generator circuit breaker QF2 are in the open state. Then, apply this startup method.
Configure the black start parameters before proceeding with the startup. For details, refer to [parameter configuration](#).
- ATS off-grid startup (diesel generator): Ensure that the grid connection circuit breaker QF1 is in the open state. Switch on the diesel generator circuit breaker QF2 manually. Then, apply this startup method.
- ATS grid-connected startup (bypass switch on): Ensure that the bypass switch is in the closed state and the diesel generator circuit breaker QF2 is in the open state.

Switch on the grid connection circuit breaker QF1 manually. Then, apply this startup method.

- ATS startup (bypass switch on, diesel generator): Ensure that the bypass switch is in the closed state and click **Diesel generator startup**. Switch on the diesel generator circuit breaker QF2 manually. Then, apply this startup method.
- Shutdown: The system sends shutdown commands to the PV and ESS devices in the system. After the shutdown is successful, their **Operating status** will be displayed as **Shutdown**.

Step 3 Select an **Operating mode**.

Three available operating modes: **Connected to gateway meter (auto on/off-grid switching disabled)**, **Connected to gateway meter (auto on/off-grid switching enabled)** and **Gateway meter not connected**. In shutdown state, set according to the actual situation. When **Connected to gateway meter (auto on/off-grid switching enabled)** is selected, the system will switch between grid-connected startup and off-grid startup according to the voltage changes at the grid-connection point.



System auto grid-connection and off-grid is not supported in the bypass mode.

Step 4 Enable or disable **Auto-start on recovery from system fault**. This function is enabled by default. When this function is enabled, if a fault occurs in the system, the system will restart automatically after recovering from the fault.



System auto-startup is not supported in the bypass mode.

Step 5 Click **Apply settings**. In the pop-up window, enter the **Task name**, then click **Confirm**.
--End

2.3.14 Plant Report

Click a plant name on the “Plant” page, and you will go to “**Overview**” by default. Then, choose **Report** on the left to access the page where you can view the **ESS time-of-use electricity report** and the **ESS revenue report** for the plant.

For detailed instructions, see [5.2 System Reports](#).

3 Device

After logging in to the web system, click **Device** in the side navigation bar to go to the page for device monitoring.

3.1 Device List

After logging into the web system, click **Device** in the side navigation bar. You will go to “Device List” by default.

Device Name	Device Model	Device S/N	Device Status	Nominal Power	Real-time Power	Daily Yield	Associated Plant	Action
逆变器1	SG50CX-P2	A23221C7573	Normal	--	0 W	196.8 kWh	德西南社区第七路...	
逆变器1	SG125CX-P2	LY00000004	Normal	--	0 W	316.9 kWh	类群4#	
PLC-4	SG320HX-20	Y2382200010	Normal	--	0 W	1.954 MWh	类群C1区SG320HX-G2	
PLC-6	SG320HX-20	Y2382200020	Normal	--	0 W	1.686 MWh	类群C1区SG320HX-G2	
逆变器11	SG320HX-20	Y2382200017	Normal	--	0 W	1.436 MWh	类群C1区SG320HX-G2	
PLC-7 >	SG320HX-20	Y2382200014	Normal	--	0 W	2.006 MWh	类群C1区SG320HX-G2	
PLC-3	SG320HX-20	Y2382200008	Normal	--	0 W	1.541 MWh	类群C1区SG320HX-G2	
PLC-5	SG320HX-20	Y2382800005	Normal	--	0 W	1.486 MWh	类群C1区SG320HX-G2	

Figure 3-1 Device List



Procedure

- Search for a device
Select a device type by choosing the corresponding tab at the top of the page. Then, select a plant, and enter the device name or S/N. Click **Search**, and devices that meet the search criteria will be shown.
- View device information
Click on the device name to go to the details page. Here you can check information such as **General Information**, **Fault**, **Curve**, **Settings**, and **Remote Signaling Status**. For detailed instructions for parameter settings, see [3.3 Parameter Setting](#).
- Switch between the list view and card view
 - Click in the upper right corner of the device list to display all devices in a list view.
 - Click in the upper right corner of the device list to display all devices in a card view.
- Change device name

Click , enter a new device name, and click **Confirm**.

- Replace a device

In case any device in the plant has been damaged or replaced, please proceed as follows to replace the device in the iSolarCloud system.

1. Click  to go to “**Device Replacement**”.
2. Check if the information about the device to be replaced is correct. If so, click  to go to “**Add New Device**”.
 - Enter the device name or S/N, and click **Search**. Then, select the new device, and click **Confirm**.
 - Click **Add Manually**, enter the S/N of the new device, and click **Confirm**.
3. Check if the information about the new device is correct. If so, click **Start Replacement**.



When replacing an inverter, you can select **Add Compensatory Yield to New Device** to add the total yield of the old device to that of the new device as compensatory yield.

- Delete a device

Click  to delete the device. This will remove all the data on the device, such as those related to the inverter and other devices.

- Battery augmentation

1. Click  to open the window for battery augmentation settings.
2. Enter **Supplement Battery Module SOC**, or click **Get** and then enter **New Battery Module S/N** to acquire the SOC value automatically.
3. Set the start time of charging/discharging in **Charging/Discharging Started**.
4. Click **Apply Settings**.

3.2 Fault List

After logging into the web system, choose **Device > Fault**. You will see the page shown below.

Pending		Resolved		Refresh Interval		5 min			
Select	Alarm Name	Alarm Type	Fault Code	Plant Name	Device Name	Device Model	Occurrence Time	Action	
<input type="checkbox"/>	Battery Fault	▲ Fault	703	上海-55#青非多机房...	储能逆变器1	SH10RS	30/Oct/2023 18:33:54		
<input type="checkbox"/>	Battery Fault	▲ Fault	703	SH10RS新样机	储能逆变器1	SH10RS	30/Oct/2023 17:27:05		
<input type="checkbox"/>	Grid Power Outage	▲ Fault	10	SH10RS新样机	储能逆变器1	SH10RS	30/Oct/2023 17:26:45		
<input type="checkbox"/>	Grid Power Outage	▲ Fault	10	LzzTest	储能逆变器7	SH10RS	24/Oct/2023 14:47:34		
<input type="checkbox"/>	System Fault	▲ Fault	38	LzzTest	储能逆变器5	SH10RS	24/Oct/2023 14:30:37		
<input type="checkbox"/>	System Fault	▲ Fault	303	sh25t	储能逆变器2	SH25T_V11	21/Oct/2023 19:11:18		
<input type="checkbox"/>	Parallel Communicat...	▲ Alarm	75	sh25t	储能逆变器2	SH25T_V11	21/Oct/2023 15:22:34		
<input type="checkbox"/>	Parallel Communicat...	▲ Alarm	75	LzzTest	储能逆变器6	SH10RS	19/Oct/2023 08:53:00		

Figure 3-2 Fault List

Procedure

- Search for a fault
 1. Select **Pending** or **Resolved**.
 2. Click **Filter**, set the **Device Model**, **Occurrence Time**, **Fault Classification**, and **Alarm Type**, and then click **Confirm**.
 3. Select the plant name, alarm name, and the fault code, and click **Search**.
- View fault details

Click or the alarm name to view the detailed information about the fault.
- Close a fault
 1. Click , or click **Close Fault** on the details page of the fault.
 2. Enter your **Processing Opinion**, and then click **Close Fault**.
- Close faults in batch
 1. Select the checkboxes of fault alarms you want to close, and click **Batch Close**.
 2. Enter your **Processing Opinion**, and then click **Close Fault**.
- Export fault data

Click to export the data of faults filtered by the current criteria.
- Check fault recording tasks
 1. Choose a fault, and click in the Action column to execute a fault recording task.
 2. Click in the upper right corner of the fault list to view the fault recording tasks.
You can choose a task and click **View** to check the voltage and current curves of the device.

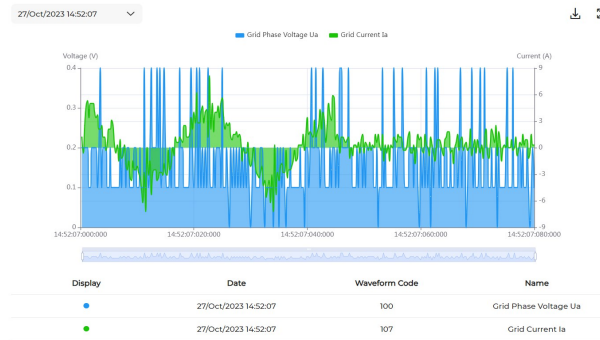

3.3 Parameter Setting

After logging into the web system, choose **Device > Settings**. Here you can set the parameters of devices in the plant.

<input type="checkbox"/>	Plant name	Device name	Grid connection status	Device S/N	Device model	Country/region	Grid type	Action
<input type="checkbox"/>	[blurred]	[blurred]	Already set	--	SH125CX-MG	United Kingdom...	50 Hz	
<input type="checkbox"/>	[blurred]	[blurred]	Already set	JR2026012402	SH5.0RS	Germany	50 Hz	
<input type="checkbox"/>	[blurred]	[blurred]	Already set	A2361215089	SH6.0RS	Germany	50 Hz	
<input type="checkbox"/>	[blurred]	[blurred]	Already set	--	SH10RT	Germany	Low voltag	
<input type="checkbox"/>	[blurred]	[blurred]	Already set	--	SH10RT	Germany	Low voltag	
<input type="checkbox"/>	[blurred]	[blurred]	Already set	JRCN05HCJ022	SH10RT	Germany	50 Hz	
<input type="checkbox"/>	[blurred]	[blurred]	Already set	JRCN05HCJ023	SH10RT	Germany	50 Hz	
<input type="checkbox"/>	[blurred]	[blurred]	Already set	JRCN05HCJ025	SH10RT	Germany	50 Hz	

Figure 3-3 Settings

Search for devices

1. Select the plant (you can select more than one plant here). Then, select the type, model, and S/N of the device, and click **Search**.
2. Click **Filter**, choose **Not Set** or **Already Set** in “Initial Grid”, and select the **Country/Region**. Then, click **Confirm**. Devices that meet the search criteria will be shown on the screen.

3.3.1 Initial Grid Connection

The settings for initial grid connection allow you to configure the inverter's parameters, including its country or region and the grid type.

Procedures

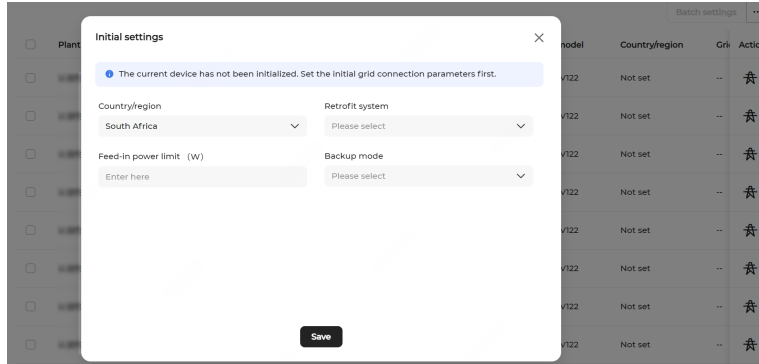

1. From the device information list, choose a plant device.
2. Click the icon  or click the button **Initial grid connection**.
3. Set **Country/region**. For some countries or regions, other grid connection-related parameters are required, such as **Grid type**, **Feed-in power limitation**, **Backup mode**, and other model-specific parameters.
4. Click **Apply settings**.











Only after you complete the **Initial grid connection** settings can you proceed to other settings.

3.3.2 Common Settings

Procedures

1. From the device information list, choose a device.
2. Click the icon  to enter the **Common settings** page.

Plant name	Device name	Grid connection status	Device S/N	Device model	Country/region	Grid type	Action
		Already set	--	SH125CX-MG	United Kingdom...	50 Hz	
		Already set	JR2026012402	SH5.0RS	Germany	50 Hz	
		Already set	A2361215089	SH6.0RS	Germany	50 Hz	
		Already set	--	SH10RT	Germany	Low voltage	
		Already set	--	SH10RT	Germany	Low voltage	
		Already set	JRCN05HG3022	SH10RT	Germany	50 Hz	
		Already set	JRCN05HG3023	SH10RT	Germany	50 Hz	
		Already set	JRCN05HG3025	SH10RT	Germany	50 Hz	

3. If you are not able to proceed with parameter settings for the device, and the following prompt appears, click **One-click update > Confirm and update**. The device will be updated automatically.

Prompt ✕

 The current communication device and inverter versions do not support parameter settings. Please update the communication device and inverter software to the latest version.

Device type	Device model	Current version	Update package
> PCS	SC125CX	(Latest)	Online update package
> Data logger	Logger1000	LOGGER-SV300.001.00.P050	Online update package  LOGGER-SV300.001.00.P...

4. Complete the settings.

According to the parameter types available in the device, configure the parameters, for example,

- Startup/shutdown
- Energy management mode
- Digital output devices setup
- Protection parameters
- Power control
- Battery parameters

The screenshot shows a web-based configuration interface for a device. At the top, there is a search bar and a 'Records' button. The main area is divided into sections: 'Startup/shutdown' (with a toggle), 'Digital output devices setup' (with a 'Disable >' link), and 'Protection parameters'. Under 'Protection parameters', there are several settings: 'Protection level' (a dropdown menu), '10-minute overvoltage protection' (a toggle), '10-min overvoltage protection threshold (V)' (a text input with value 258.0 and range [230.1-322.0]), '10-min overvoltage recovery threshold (V)' (a text input with value 256.0 and range [230.0-321.9]), 'Criteria for islanding detection' (a dropdown menu with 'Disable' selected), and 'LVRT zero power mode' (a toggle). Below these is a table for LVRT settings:

	LVRT voltage (V)	LVRT time (ms)
1	180.0 Range: [0.0-230.0]	10000 Range: [40-14,400,000]
2	70.0 Range: [0.0-230.0]	1000 Range: [40-14,400,000]

Further down, there are settings for 'LVRT grid unbalance support' (toggle), 'LVRT K factor' (text input with value 0.0 and range [0.0-10.0]), 'HVRT zero power mode' (toggle), 'HVRT' (toggle), and 'HVRT protection level' (dropdown menu with value 1). At the bottom right, there are 'Refresh' and 'Save' buttons.

The supported common settings vary by device. Please refer to the actual page.

5. Click **Apply settings**.

Local controllers do not support common settings.

3.3.2.1 Common Data Logger Settings

To configure common settings for the data logger, from the device list, click the icon for the device for its common settings.

3.3.2.1.1 Charging Management

Procedure

- In the **Common settings** window, click the **Charging management** tab to set the charging mode and related parameters. Modes include:
 - ECO & economic charging

The PV power will be first used for the loads, with any surplus supplied to the EV charger. If the surplus falls below the charger's minimum charging power, the system will either ensure the minimum charging power for the charger or stop charging, depending on whether drawing power from the grid is allowed.

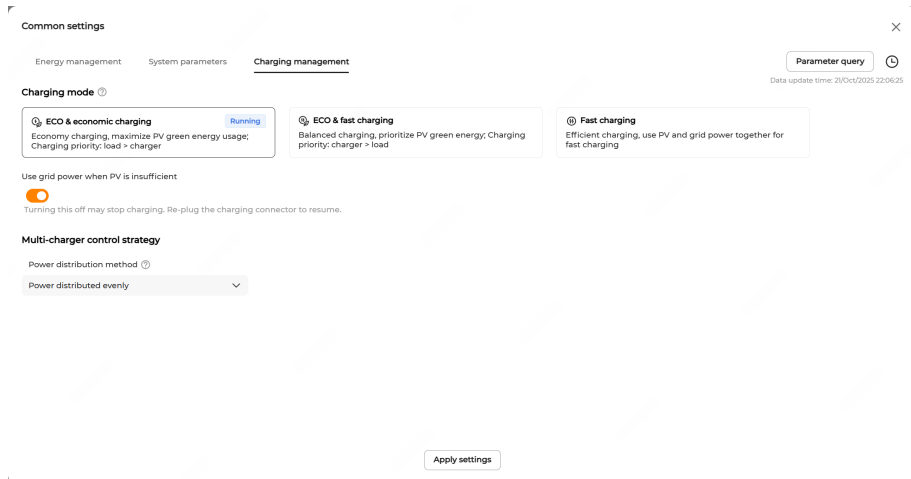

- **ECO & fast charging**

The EV charger maximizes the use of PV energy. If PV power exceeds the charger's minimum charging power, no additional power will be drawn from the grid. Conversely, if PV power falls short, the charger can supplement with grid power to meet the minimum charging power.

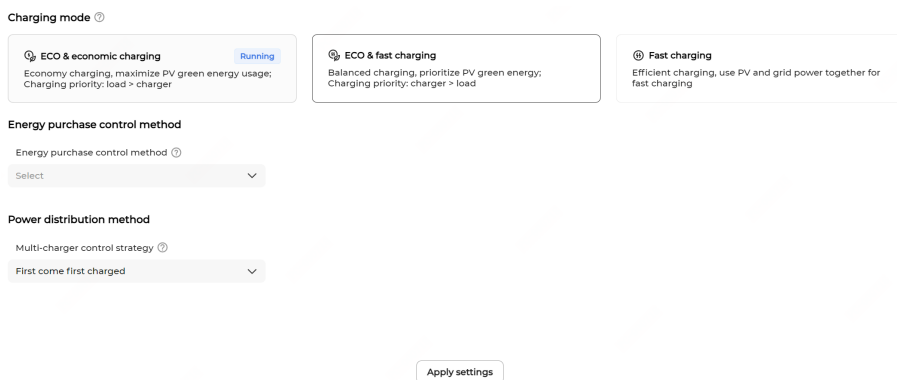

- **Fast charging**

The charger can use both PV energy and grid energy. In this mode, the charger operates at the rated power, delivering the exact power required by the EV.

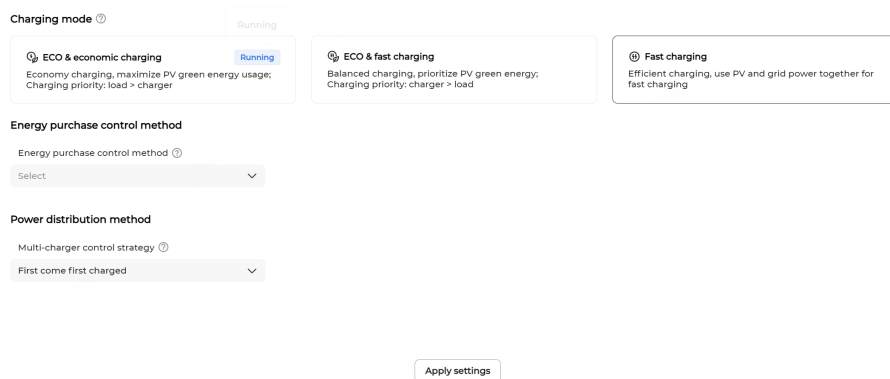

Table 3-1 Parameter Description

Parameter	Description
Use grid power when PV is insufficient	It is turned on by default. Turning the option off may interrupt the charging process. To resume, re-plug the charging connector.
Use battery when PV is insufficient	It is turned on by default.
Power distribution method	Decide how you want to distribute power when working with the multi-charger control strategy. It is to allocate power across chargers based on the preset strategy to meet users' varying charging demands. Options include: <ul style="list-style-type: none"> • First come first charged: Based on the charging order and grid power limits, the system allocates power according to EV actual needs, prioritizing earlier comers. • Power distributed evenly: Allocate charging power evenly according to the EV quantity and grid power limits.

2. Click **Apply settings**.

3.3.2.1.2 Energy Management

By leveraging Logger1000 to manage energy dispatch in the system, users can select the ESS operating mode as needed to manage and utilize electricity effectively.



The energy management function in Logger1000 is being phased in on different regional servers, and the actual system display shall prevail.

On the **Common settings** page of Logger1000, select **Energy management**. The following operating modes are available:

Mode	Description
AI mode	Applicable to the PV-ESS scenario where tariff, weather, and electricity demand fluctuate and cannot be predicted. In the AI mode, the system predicts PV yield and load demand based on the meteorological data, and leverages real-time tariff to decide on the optimal electricity dispatch strategy, thus maximizing the revenue.
Self-consumption	Applicable to scenarios where the PV output is sufficient to meet the load demand. In this mode, the system uses the PV system and battery storage at maximum for power

Mode	Description
	supply, and users can achieve energy self-sufficiency through demand control and battery usage plans.
Time plan	Applicable to scenarios where the peak-valley tariffs differ greatly. Users can set the specific charging and discharging time periods and power to minimize the electricity costs.
Forced mode	Applicable to scenarios where the ESS is required to promptly respond to the charging and discharging commands. This mode is mainly used for battery maintenance and supports to manually control charging and discharging. It is recommended to select it during the system installation and commissioning.

i When Logger1000 operates in the VPP mode or external energy dispatch, the plant is controlled by a third party, and mode switching is not allowed.

3.3.2.1.2.1 AI Mode

In the AI mode, the system predicts PV yield and load demand based on the meteorological data, and leverages real-time tariff to decide on the optimal electricity dispatch strategy, thus maximizing the revenue.

Prerequisite

- i** AI mode is supported only when the **Consumption tariff** type is set to **Dynamic tariff** or **Time-of-use tariff**.
- A certain amount of data accumulation is required for AI mode to predict future production and consumption more accurately.

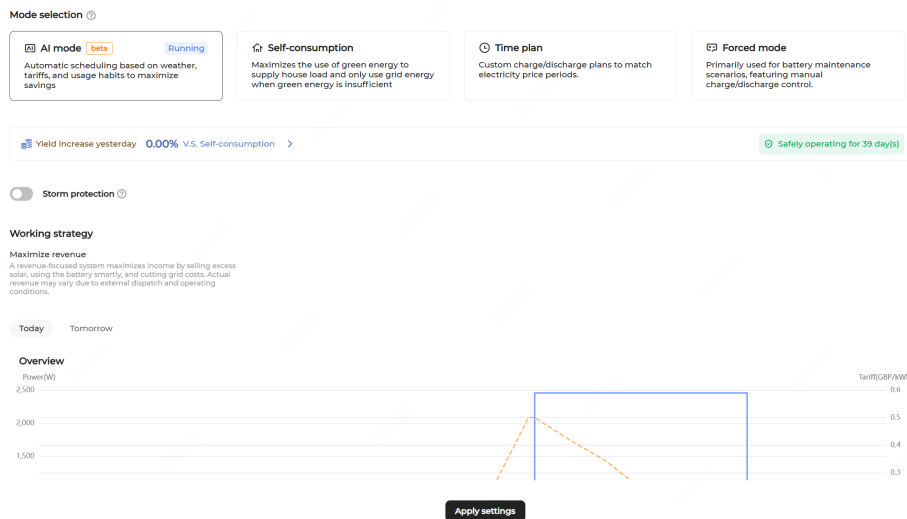

Step 1 Navigate to the **Energy management** page and select the **AI mode**.

Step 2 **Yield increase yesterday** is displayed on the page. You can click it to go to the **Revenue calendar** screen and view monthly, annual, and total yield increase percentages or values.

Step 3 Turn on or off **Storm protection** as needed.

- If the function is enabled, upon receiving an extreme weather alert, the system charges at maximum capacity until reaching the SOC upper limit, ignoring all the preset restrictions. When the extreme weather ends, the system will restore to the previous operating mode.
- If the function is disabled (default), the system will work as per the set working strategy.

Step 4 Click **Apply settings**.

When the system operates in this mode, the **AI mode** page displays today's yield and consumption and curves about tariff and battery working strategy. Click **Tomorrow** to view the energy use forecast curve for the next day.

--End

3.3.2.1.2.2 Self-Consumption

The **Self-Consumption** mode maximizes the utilization of PV output and battery energy to power the loads, thus minimizing grid energy consumption. Users can configure specific time periods for **Allow Discharging** and **Force Charging** based on electricity rates to optimize energy costs.

Function Logic

- When the PV output power is sufficient, the energy will be first supplied to the loads, with the excess stored in the battery. Any remaining energy beyond battery capacity will be fed into the grid.
- If the PV output power is insufficient to meet the load demand, the system discharges the battery to compensate. If the battery capacity is insufficient, the system draws power from the grid to meet the load demand.

Procedure

1. Navigate to the **Energy Management** page and select the **Self-Consumption** mode.
2. Set the **Threshold on Power Purchase (Demand Control)** and **Threshold on Power Feed-in (Demand Control)**.
 - **Threshold on Power Purchase (Demand Control):** When the power imported from the grid exceeds the set threshold, the battery will cover the excess demand.
 - **Threshold on Power Feed-in (Demand Control):** When the power fed into the grid exceeds the set threshold, the excess will be used to charge the battery.
3. Enable **Custom Month Span**. For details, see [3.3.2.1.2.2.1 Custom Month Span](#).



If **Custom Month Span** is disabled, the battery is allowed to discharge all day (0-24h) without charging.

4. Click **Apply Settings**.

3.3.2.1.2.2.1 Custom Month Span

In the **Self-Consumption** mode, users can set battery charging/discharging plans to optimize the energy usage and management. With properly set battery charging/discharging windows, the system maximizes the use of PV output during on-peak hours and reduces the energy purchased from the grid during off-peak hours, thus lowering the electricity costs.

Function Logic

- **Allow Discharging:** Allow the battery to discharge to power the loads in a specific time period. All-day by default (0–24h).
- **Force Charging:** Charge the battery at the maximum allowable power in a specific time period until the target SOC is reached. If the PV output is insufficient to meet the battery charging power demand, the system is allowed to charge the battery with energy from the grid.



Battery discharging and charging windows can overlap. Force charging takes priority if a time window is set for both battery discharging and force charging.

Procedure

1. Enable **Custom Month Span**.
2. Set the desired month span. You can set different time windows based on seasonal energy demand patterns.
3. Select the days on which the battery charging/discharging plan applies. You can apply the charging/discharging plan to all days, or set different charging/discharging plans for weekdays and weekends. The work plan applies to all days by default.
 - **Every Day:** The set charging/discharging plan applies on all days. This option is ideal for scenarios where the daily energy demand is relatively stable.
 - **Weekdays & Weekends:** Set different charging/discharging plans for weekdays and weekends.
4. To add more month spans, click **Add** to the right of the default month span name.



You can select a month span and click  to modify its name or delete it.

5. Click on a time period in the **Allow Discharging** time bar. A new discharging window will be created (1 hour by default). Then, drag the left or right edge of the window to adjust the length of time.
6. Click on a time period on the **Force Charging** row, a new charging window will be created (1 hour by default). Then, drag drag the left or right edge of the window to adjust the length of time.

Click a time window that has been added, set a charging target in **Target SOC (%)**.

3.3.2.1.2.3 Time Plan

The **Time Plan** mode is mainly used for electricity trading scenarios. Users can set the time windows and power for battery charging/discharging according to the on- and off-peak electricity prices to maximize the economic benefits.

It is recommended to schedule battery discharge during on-peak hours (electricity prices are higher) and charge during off-peak hours (electricity prices are lower).

Function Logic

- **Discharge Period:** The battery discharges at the predefined discharging power within the set time period until it is fully discharged.
- **Charge Period:** The battery charges at the predefined charging power within the set time period until it is fully charged.

Procedure

The screenshot displays the 'Time plan' configuration screen. At the top, there are four mode selection options: 'AI mode' (highlighted in orange), 'Self-consumption', 'Time plan' (selected with a radio button), and 'Forced mode'. Below these are two target SOC (%) sliders: 'Battery charge target SOC (%)' set to 100 and 'Battery discharge target SOC (%)' set to 0. A 'Select month' dropdown is set to 'Jan'. The 'Time period' is set to 'Every day'. The main area is a 24-hour timeline with a legend for 'Discharge' (green) and 'Charge' (orange). Two events are scheduled: a discharge from 09:00-12:00 at 1.00kW and a charge from 15:00-17:00 at 0kW. An 'Apply settings' button is at the bottom.

1. Navigate to the **Energy Management** page and select the **Time Plan** mode.
2. Set the desired month span. You can set different time windows based on seasonal energy demand patterns.
3. Select the days on which the battery charging/discharging plan applies. You can apply the charging/discharging plan to all days, or set different charging/discharging plans for weekdays and weekends. The work plan applies to all days by default.
 - **Every Day:** The set charging/discharging plan applies on all days. This option is ideal for scenarios where the daily electricity price is relatively consistent.
 - **Weekdays & Weekends:** Set different charging/discharging plans for weekdays and weekends.
4. To add more month spans, click **Add** to the right of the default month span name.



Before adding a month span, you must first configure the charge and discharge settings for the current month span.

You can select a month span and click  to modify its name or delete it.

- Click on a time period in the **Discharge** or **Charge** time bar. A new discharging or charging window will be created (1 hour by default). Then, drag the left or right edge of the window to adjust the time range.



The charging and discharging windows cannot overlap.
The battery will not discharge in a time period with no settings. If the PV output is insufficient to meet the load demand, the system purchases energy from the grid to meet the load demand, and allows the battery to charge from the excess PV energy.

- Click a time window that has been added, set the discharging or charging power in **Power**.
- Click **Apply Settings**.

3.3.2.1.2.4 Forced Mode

The **Forced Mode** is mainly used in battery O&M to ensure it operates in compliance with the preset charging/discharging mode and power. Restore the system to the previous working mode after maintenance work is completed.

Function Logic

- Forced Charging: The battery charges at the preset charging power until it is fully charged.
- Forced Discharging: The battery discharges at the preset discharging power until it is fully discharged.

Procedure

The screenshot shows the 'Common settings' window with the following elements:

- Tab: **Energy management** (selected), Power control, System parameters
- Buttons: Self-consumption, Time plan, **Forced mode** (selected), VPP, Mode description
- Parameter query button and refresh icon
- Data update time: 2025-09-01 22:34:46
- Charging/discharging command: Charge (dropdown menu)
- Charging/discharging power(kW): 0 (input field)
- Range: [0.00, 90.00]
- Apply settings button

- Navigate to the **Energy Management** page and select the **Forced Mode**.
- Set the **Charging/Discharging Command**.
 - Charge**: Force the battery to charge at the preset charging power until the battery SOC upper limit is reached.

- **Discharge:** Force the battery to discharge at the preset discharging power until the battery SOC lower limit is reached.
 - **Stop:** Stop battery charging or discharging.
3. If **Charge** or **Discharge** is selected, set the target charging or discharging power in **Charging/Discharging Power**.
 4. Click **Apply Settings**.

3.3.2.1.3 Power Control

Power control supports two ways, DI power regulation and grid-connected power control.

From the device list, choose the icon  for the data logger to go to the settings page, where you can choose the **Power control** tab.

3.3.2.1.3.1 DI Power Regulation

Digital input (DI) power regulation supports demand response modes (DRM) and Ripple Control dry contact input. If an emergency stop device is connected, you can also configure its relevant settings.



If the DI power control is not needed, set **DI control method** to **Close**.

Go to the **Power control** page and select **Digital input power regulation**.

3.3.2.1.3.1.1 DRM

DRM is a power control method that responds to external demands. In this context, power control is carried out according to the received external DRM signals.

Procedure

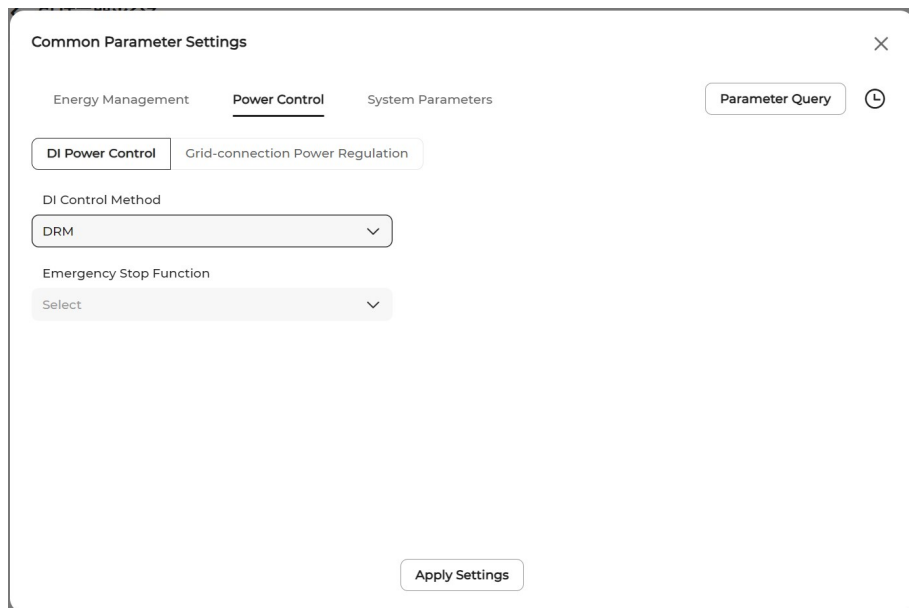

1. Navigate to **DI Power Control** page.

2. Set **DI Control Method** to **DRM**.

3. Click **Apply Settings**.

3.3.2.1.3.1.2 Ripple Control

In the Ripple Control mode, the system receives control signals from the grid through dry contact signals, and performs power control as required.

If the Ripple Control mode is selected, the grid operator will convert the dispatch signals into the dry contact signals for transmission. A total of 16 DI combinations are available, each with a specific power ratio. Please set the DI combination for the system so that it can receive and respond to grid signals properly.

Table 3-2 DI Interface Status

Icon	Description
<input type="checkbox"/>	This DI interface is in the open state.
<input checked="" type="checkbox"/>	This DI interface is in the closed state.

 Each DI combination must be unique.

Procedure

Common Parameter Settings
×

Energy Management
Power Control
System Parameters
Parameter Query ⌵

DI Power Control
Grid-connection Power Regulation

DI Control Method
 ⌵

Inverter Output Power Limit Ratio Calculation Basis
 ⌵

Total Installed Power of Modules
 kW
Range:[0.00, 999999.99]

No.	DI1	DI2	DI3	DI4	P%
01	<input checked="" type="checkbox"/>	<input checked="" type="checkbox"/>	<input type="checkbox"/>	<input type="checkbox"/>	30

+
 Add DI Combination

Note: Disconnect Closed Range : 0 ~ 100%

Emergency Stop Function
 ⌵

Apply Settings

1. Navigate to **DI Power Control** page.
2. Set the **DI Control Method** to **Ripple Control**.
3. Set the **Inverter Output Power Limit Ratio Calculation Basis**.
 - **Nominal Power**: The dispatch value is calculated based on the rated power of the inverter that is connected.
 - **Installed PV Power**: The dispatch value is calculated based on the installed PV power of the inverter that is connected. Please enter the **Total Installed Power of Modules** based on the actual plant conditions.
4. Select DI ports, and set a power ratio in a range of 0-100%.



Set DI combinations based on the control signals sent from the grid operator.

5. Click **Add DI Combination** to add other DI combinations.
6. Click **Apply Settings**.

3.3.2.1.3.1.3 Emergency Stop Function

The emergency stop function allows users to stop the inverter immediately in case of an emergency.



The emergency stop function is available for SUNGROW inverters only.

Table 3-3 Emergency Stop Modes

Mode	Description
OFF	Emergency stop control is disabled.
Stop Inverter	When emergency stop is triggered, the inverter enters the emergency stop state.
Stop Inverter and Trip Battery	When triggered, the inverter stops exporting power to the grid, and the battery ceases all interactions with the inverter or grid, neither charging nor discharging. Both the inverter and battery enter standby mode.

Procedure

Emergency Stop Function

Stop Inverter



Emergency Stop Status

Disconnect



1. Navigate to **DI Power Control** page.
2. In the **Emergency Stop Function** drop-down list, select OFF to disable the function or choose a desired emergency stop mode to enable it.
3. If **Stop Inverter** or **Stop Inverter and Trip Battery** is selected, select a trigger condition in the drop-down list of **Emergency Stop Status**.
 - **Disconnect**: Emergency stop will be triggered when DI opens.
 - **Closed**: Emergency stop will be triggered when DI closes.

4. Click **Apply Settings**.

3.3.2.1.3.2 Grid-Connected Power Control



Users must first configure the energy purchase control method and feed-in control strategy for the ESS. These thresholds define the system's maximum power limits in grid-connected operation, ensuring stability and energy efficiency, and will influence the actual power control range.

Step 1 Access the **Power control** screen and select **Grid-connected power control**.

Step 2 Set the following parameters.

Parameter	Description
Energy purchase control method	<p>Available options:</p> <ul style="list-style-type: none"> No limit Purchase energy with limited power
Power limit for energy purchase	<p>When Purchase energy with limited power is selected, input a value here, which is generally based on the breaker capacity on the grid connection point. An exceedingly high value will cause overcurrent tripping, while an exceedingly low value will impact the startup of controllable loads, including the chargers.</p>
Feed-in control method	<p>Set one of the following feed-in power control methods and the corresponding values according to the requirements of the local grid company to prevent the system from feeding back more power than the settings. Available options:</p> <ul style="list-style-type: none"> Total active power control: The meter collects data of three phases on the grid-connected side as feedback values for power control. Per-phase active power control: The meter collects data of a single phase as feedback values for power control.

Parameter	Description
Power output method	<p>Set this option when the Feed-in control method is set to Per-phase active power control, and choose either of the following methods:</p> <ul style="list-style-type: none"> • Three-phase balanced output: Limit the output power of each phase based on the maximum grid feed-in power among the three phases. • Three-phase unbalanced output: Limit the output power of each phase based on its own actual grid feed-in power. <div style="border: 1px solid gray; padding: 10px; margin-top: 10px;"> <ul style="list-style-type: none"> • Per-phase active power control is available only when the inverter supports power feed-in per phase. • When the option Per-phase active power control is selected, the Peak shaving mode under the Self-consumption energy management mode is disabled. If the Peak shaving mode is previously on, when you apply the settings, the mode is automatically turned off. </div>
Power limitation	Turn it on or off as needed. It is off by default.
Feed-in power limit value/ratio	<ul style="list-style-type: none"> • When both of the following conditions are met, define Feed-in power limit value/ratio according to the grid requirements. <ul style="list-style-type: none"> a. Feed-in control method is set to: <ul style="list-style-type: none"> - Total active power control - Per-phase active power control, and Three-phase balanced output is selected as the Power output method. b. Power limitation is enabled. • When both of the following conditions are met, define Phase A/B/C feed-in power limit value/ratio according to the grid requirements. <ul style="list-style-type: none"> a. Feed-in control method is set to Per-phase active power control, and Three-phase unbalanced output is selected as the Power output method. b. Power limitation is enabled. • You can switch the unit between kW and % to define the power limit value or ratio. • When defining the feed-in power limit ratio or phase A/B/C feed-in power limit ratio, set Feed-in power limit ratio calculation basis to Nominal power or Installed PV
Phase A/B/C feed-in power limit value/ratio	

Parameter	Description
	<p>power. When the latter is selected, specify Total installed power of modules.</p> <div style="border: 1px solid gray; padding: 5px;"> <p> Feed-in power limit ratio calculation basis means that the power limit ratio is calculated based on one-third of the nominal power (total installed power).</p> </div>
Third-party power generation systems	<p>When you switch it on, specify Rated power of third-party power generation system.</p> <div style="border: 1px solid gray; padding: 5px;"> <p> If a third-party inverter is connected to the system, you can define the value based on the rated power of the inverter.</p> </div>

Step 3 Click **Apply settings**.

--End

3.3.2.2 Common iHomeManager Settings

To configure common settings for iHomeManager, from the device list, click the icon  for the device for its common settings.

3.3.2.2.1 Energy Management

The system provides various energy management modes to ensure effective energy management and maximum energy utilization.

The following working modes are available:

- AI mode
- Self-consumption
- Time plan
- Forced mode



- When iHomeManager is under the third-party dispatch mode, the **Energy management** page displays VPP mode operation or external energy dispatch. Under this mode, the plant is controlled by a third party, and mode switching is not allowed.
- The actual configuration parameters of the energy management mode vary in different servers and shall prevail.

3.3.2.2.1.1 AI Mode

In the **AI mode**, the system predicts future PV yield and household electricity use, based on the meteorological data and the user's consumption profile. It then decides on an optimal

strategy to control battery charging/discharging and electricity usage in the household, thus maximizing the clean energy usage or the revenue.



- AI mode is supported only when the **Consumption tariff** type is set to **Dynamic tariff** or **Time-of-use tariff (weekdays+weekends)**.
- A certain amount of data accumulation is required for AI mode to predict future production and consumption more accurately.

The screenshot displays the Energy Management settings page. At the top, there is a 'Mode selection' section with four options: 'AI mode' (beta, Running), 'Self-consumption', 'Time plan', and 'Forced mode'. Below this is a status bar showing 'Yield increase yesterday 39.15%' and 'v.S. Self-consumption' with a right arrow, and a green indicator 'Safely operating for 31 day(s)'. The 'Storm protection' section is currently turned on. Under 'Smart load', there are five priority slots: Kitchen (Priority:1), Drying Machine (Priority:2), heat_pump (Priority:3), Washing Machine (Priority:4), and charger1 (Priority:5). The 'Working strategy' section has two radio buttons: 'Maximize PV energy usage' (selected) and 'Maximize revenue'. An 'Apply settings' button is located at the bottom right of the settings area.

Procedure

1. Navigate to the **Energy management** page and select the **AI mode**.
2. Turn on or off **Storm protection** as needed.
 - If the **Storm protection** is enabled, upon receiving an extreme weather alert, the system charges at maximum capacity until reaching the SOC upper limit, ignoring all the preset restrictions. When the extreme weather ends, the system will restore to the previous working mode.
 - If the function is disabled, the system will work as per the set working strategy.
3. Set the priority for the smart loads. Hold and drag the load to adjust the load priority. The closer to the front, the higher the priority.
4. Set **Working strategy** to **Maximize revenue** or **Maximize PV energy usage**.
 - Maximizing PV energy usage is to optimize the PV energy to power household loads, only purchasing energy from the grid when PV energy is insufficient.
 - Maximizing revenue is to achieve optimal revenue by selling the excess power, optimizing energy storage, and reducing the electricity costs.
5. The current page allows you to view data, including yield today and curves about energy use, tariff, and battery working strategies. Click **Tomorrow** to view the energy use forecast curve for tomorrow.
6. Click **Apply settings**.

3.3.2.2.1.2 Self-Consumption

The **Self-consumption** mode prioritizes the use of PV green energy, only drawing energy from the grid when the PV supply is insufficient. By maximizing the use of PV output and

battery energy to supply the loads, this mode helps minimize energy purchase from the grid and reduce the electricity costs.

Function Logic

- Under sufficient sunlight, the power supply priority is: PV energy first serves household loads and then charges the battery, with the excess energy fed to the grid.
- Under insufficient sunlight, the power supply priority is: PV energy first serves household loads, and when PV output falls short, the battery discharges for compensation. If the power is still not enough, energy is purchased from the grid.



The actual configuration parameters of the self-consumption mode vary in different servers and shall prevail.

3.3.2.2.1.2.1 Self-Consumption (European Server)

The screenshot displays the configuration page for the Self-Consumption mode. At the top, there are four mode selection options: AI mode (beta), Self-consumption (selected), Time plan, and Forced mode. Below this, the Peak shaving mode is set to 'On'. The Reserved SOC for peak shaving is set to 1, with a range of 0-100. The bottom section features a 'Time period' chart for 'Every day' with a legend for 'Peak shaving limit' (blue) and 'Feed-in peak power' (light blue). The chart shows a peak shaving limit from 02:15 to 04:00 with a power of 0kW, and a feed-in peak power period from 00:00 to 24:00 with a power of 0.00kW. An 'Apply settings' button is located at the bottom right of the chart area.

Step 1 Navigate to the **Energy management** page and select the **Self-consumption** mode.

Step 2 Enable **Peak shaving mode** to adjust energy purchase and feed-in plan. Configure the following:

- Set **Reserved SOC for peak shaving (%)**.
 - If the battery SOC is higher than this reserved threshold, the battery is discharged first to supply power to the loads.
 - If the battery SOC is lower than this reserved threshold, energy is purchased from the grid. When the grid power limit is reached, the battery continues to discharge to meet the load demand.
- Configure the time periods for **Feed-in peak power** and **Peak shaving limit**. See [3.3.2.1.2.2.1 Custom Month Span](#) for details.



If the feed-in control method is set to per-phase active power feed-in limit, the **Peak shaving mode** cannot be enabled.

Step 3 Click **Apply settings**.

--End

3.3.2.2.1.2.1.1 Custom Season

In the **Self-consumption** mode, users can set a battery charging/discharging plan to optimize the energy usage and management. With properly set battery charging/discharging windows, the system maximizes the use of PV output during on-peak hours and reduces the energy purchased from the grid during off-peak hours, thus lowering the electricity costs.

Steps

1. Select months for the current season. Users can set different seasons according to the energy demand and seasonal changes of each quarter.
2. Select the days on which the battery charging/discharging plan applies. You can apply the Peak shaving limit/Feed-in peak power to every day, or set different charging/discharging plans for weekdays and weekends respectively. The plan applies to every day by default.
 - **Every Day:** The set Peak shaving limit/Feed-in peak power applies on all days. This mode is suitable for scenarios where the daily energy demand is relatively stable.
 - **Weekdays & Weekends:** Set different Peak shaving limit/Feed-in peak power respectively for weekdays and weekends.
3. To add more seasons, tap  to the right of the default season name and select **Add**.



You can select a season and tap  to modify its name or delete it.

4. Tap a time period on the **Peak shaving limit** and **Feed-in peak power** column, a new discharging window will be created (1 hour by default). Then, drag up and down to adjust the length of time, and tap on the window again to add it.



The time bands for **Peak shaving limit** and **Feed-in peak power** supply can overlap.

3.3.2.2.1.2.2 Self-Consumption (Australian Server)

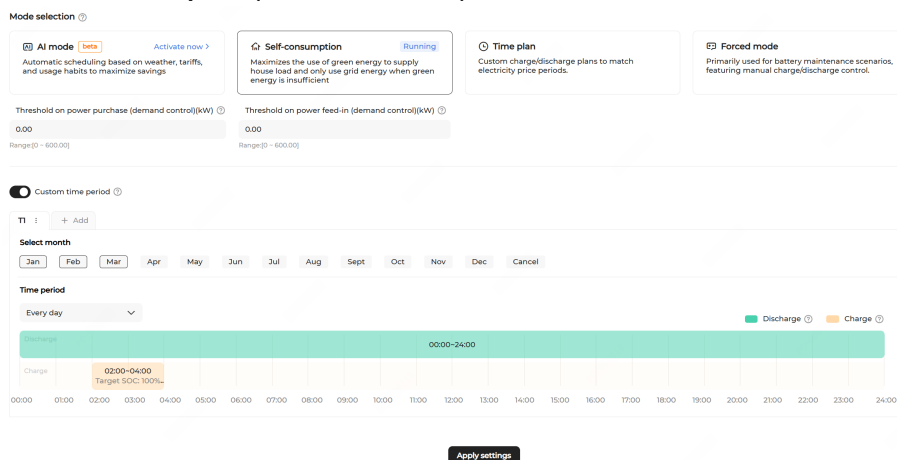



Mode selection 

- AI mode** (beta) Activate now >
Automatic scheduling based on weather, tariffs, and usage habits to maximize savings.
- Self-consumption** (Running)
Maximizes the use of green energy to supply house load and only use grid energy when green energy is insufficient.
- Time plan**
Custom charge/discharge plans to match electricity price periods.
- Forced mode**
Primarily used for battery maintenance scenarios, featuring manual charge/discharge control.



Threshold on power purchase (demand control)(kW) 
0.00
Range: [0 - 600.00]



Threshold on power feed-in (demand control)(kW) 
0.00
Range: [0 - 600.00]

Custom time period 

T1  + Add

Select month

Time period
 Every day  

Discharge  ■ Charge  ■

00:00 01:00 02:00 03:00 04:00 05:00 06:00 07:00 08:00 09:00 10:00 11:00 12:00 13:00 14:00 15:00 16:00 17:00 18:00 19:00 20:00 21:00 22:00 23:00 24:00

Apply settings 

Step 1 Navigate to the **Energy management** page and select the **Self-consumption** mode.

Step 2 Set **Threshold on power purchase (demand control)**. When the power imported from the grid exceeds the set threshold, the battery will cover the excess demand.

Step 3 Set **Threshold on power feed-in (demand control)**. When the feed-in power exceeds the set threshold, the battery stores the excess power.

Step 4 Enable **Custom time period**. For details, see [3.3.2.1.2.2.1 Custom Month Span](#).

Step 5 Click **Apply settings**.

--End

3.3.2.2.1.2.2.1 Time Plan Setup

In the **Self-consumption** mode, you can set battery charging/discharging plans to optimize the energy usage and management. With properly set battery charging/discharging periods, the system maximizes the use of PV output during peak hours and reduces the energy purchased from the grid during off-peak hours, thus lowering the electricity costs. When the time plan is customized, the battery does not charge or discharge outside the defined charging/discharging periods.

Allow Discharging

The battery is allowed to discharge to supply the loads in the specified time period. The default time period is all day (0 – 24h).

Forced Charging

In the specified time period, charge the battery at its maximum allowable power until reaching the preset target SOC.



Battery discharging and charging periods can overlap. If a time period allows both battery discharging and forced charging, forced charging will be prioritized.

Procedure

1. Turn on **Custom time period**.
2. Select months for the current time period. You can set different time periods based on seasonal energy demand patterns.
3. Select the cycling mode of the battery charging/discharging plan.
You can apply the charging/discharging plan to every day, or set different charging/discharging plans for weekdays and weekends. The plan cycles every day by default.
 - **Every day**: The set charging/discharging plan applies to all days. This option is ideal for scenarios where the daily energy demand is relatively consistent.
 - **Weekdays & weekends**: Set different charging/discharging plans for weekdays and weekends.
4. Click a time period in the **Discharge** time bar to add a new discharging period (1 hour by default). Then, drag the left or right border of the bar to adjust the duration.
5. Click a time period in the **Charge** time bar to add a new charging period (1 hour by default). Then, drag the left or right border of the bar to adjust the duration.
Click an added time period and choose **Set target SOC** to set a charging target.

6. To add time periods, click **Add** to the right of the default time plan.



To delete a time plan or modify its name, select it and click .

3.3.2.2.1.3 Time Plan

The **Time plan** mode is mainly used in electricity trading scenarios. By leveraging the differences between peak and off-peak electricity prices, you can manually set the time periods and corresponding power for battery charging and discharging to maximize economic benefits.

It is recommended to set discharge periods during price peaks and charge periods during price valleys.



The actual configuration parameters of the self-consumption mode vary in different servers and shall prevail.

3.3.2.2.1.3.1 Time Plan (European Server)

Mode selection 

AI mode beta Running
Automatic scheduling based on weather, tariffs, and usage habits to maximize savings

Self-consumption
Maximizes the use of green energy to supply house load and only use grid energy when green energy is insufficient

Time plan
Custom charge/discharge plans to match electricity price periods.

Forced mode
Primarily used for battery maintenance scenarios, featuring manual charge/discharge control.

Battery charge target SOC(%)
100
Range: [0 - 100]

Battery discharge target SOC(%)
0
Range: [0 - 100]

T1
Select month
Jan Feb Mar Apr May Jun Jul Aug Sept Oct Nov Dec Cancel

Time period
Every day

Discharge: 09:00-12:00 Power: 1.00kW >
Charge: 15:00-17:00 Power: 0.6kW >

Perform self-consumption in remaining time 

Apply settings

Function Logic

- Discharging period: The battery discharges at the predefined discharging power within the set time period until the battery discharge target SOC is reached.
- Charging period: The battery charges at the predefined charging power within the set time period. If PV power is sufficient, the battery charges until it is fully charged. If PV power is insufficient, it charges until the battery charge target SOC is reached.

Step 1 Navigate to the **Energy management** page and select the **Time plan** mode.

Step 2 Set the **Battery charge target SOC (%)**: Charging stops when the battery reaches the target charging SOC.

Step 3 Set the **Battery discharge target SOC (%)**: Discharging stops when the battery drops to the target discharging SOC.

Step 4 Select months for the current time period. You can set different time periods based on seasonal energy demand patterns.

You can add and delete a time plan, and modify its name.



- To add time periods, click **Add** to the right of the default time plan.
- To delete a time plan or modify its name, select it and click  .

Step 5 Select the cycling mode of the battery charging/discharging plan.

You can apply the charging/discharging plan to every day, or set different charging/discharging plans for weekdays and weekends.

- **Every day:** The set charging/discharging plan applies to all days. This mode is ideal for scenarios where the daily electricity price is relatively consistent.
- **Weekdays & weekends:** Set different charging/discharging plans for weekdays and weekends.

Step 6 Click a time period in the **Discharge** or **Charge** column to add a new discharging/charging period. Then, drag up and down to adjust the duration, and click the period again to complete.



- The charging and discharging periods cannot overlap.
- The battery will not discharge in a time period with no settings. If the PV output is insufficient, the system purchases energy from the grid to meet the load demand, and allows the battery to charge from the excess PV energy.

Step 7 Click an added time period, and set **Power** for discharging or charging.

Step 8 Enable or disable **Perform self-consumption in remaining time**. When enabled, the system operates in the self-consumption mode outside the defined charging/discharging time periods.

Step 9 Click **Apply settings**.

--End

3.3.2.2.1.3.2 Time Plan (Australian Server)

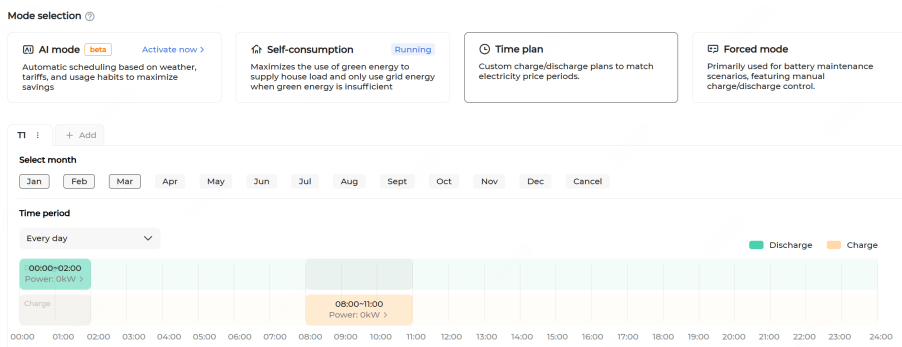

Function Logic

- **Discharging period:** The battery discharges at the predefined discharging power within the set time period until it is fully discharged.
- **Charge period:** The battery charges at the predefined charging power within the set time period until it is fully charged.

Step 1 Navigate to the **Energy management** page and select the **Time plan** mode.

Step 2 Select months for the current time period. You can set different time periods based on seasonal energy demand patterns.



You can add and delete a time plan, and modify its name.

- To add time periods, click **Add** to the right of the default time plan.
- To delete a time plan or modify its name, select it and click  .

Step 3 Select the cycling mode of the battery charging/discharging plan.

- **Every day:** The set charging/discharging plan applies to all days. This mode is ideal for scenarios where the daily electricity price is relatively consistent.
- **Weekdays & weekends:** Set different charging/discharging plans for weekdays and weekends.

Step 4 Click a time period in the **Discharge** or **Charge** column to add a new discharging/charging period. Then, drag up and down to adjust the duration, and click the period again to complete.



- The charging and discharging periods cannot overlap.
- The battery will not discharge in a time period with no settings. If the PV output is insufficient, the system purchases energy from the grid to meet the load demand, and allows the battery to charge from the excess PV energy.

Step 5 Click an added time period, and set **Power** for discharging or charging.

Step 6 Click **Apply settings**.

--End

3.3.2.2.1.4 Forced mode

For detailed descriptions and configurations of forced mode, see [3.3.2.1.2.4 Forced Mode](#).

3.3.2.2.2 Power Control

Power control includes **Digital input power regulation** and **Grid-connected power control**. Click **Power control** and choose a tab for the corresponding settings.

3.3.2.2.2.1 DI Power Regulation

On the European server, the digital input (DI) power regulation supports Ripple Control and EnWG 14a. On the Australian server, the DI power regulation supports Ripple Control and Demand Response Management (DRM).

If an emergency stop device is connected, you can also configure its relevant settings.



If the DI power regulation is not needed, set **DI control method** to **Off**.

3.3.2.2.2.1.1 Via Ripple Control

Refer to [3.3.2.1.3.1.2 Ripple Control](#) for the descriptions and procedure of Ripple Control and to [3.3.2.1.3.1.3 Emergency Stop Function](#) for details of the emergency stop.

3.3.2.2.1.2 Via EnWG 14a



- This function is only available on the European server.
- It is available on iHomeManager-SV930.001.00.P008 or higher.
- When enabled, the EnWG 14a mode (from Paragraph 14a of the Energiewirtschaftsgesetz (EnWG) in Germany, or German Energy Act in English) sets a battery charging power limit on the whole system. Even under emergency charging, the charging power drawn from the grid cannot exceed 4.2 kW.
- After the EnWG 14a mode is turned on, the control strategies for chargers and heat pumps are automatically disabled. After the EnWG 14a mode is turned off, the control strategies for chargers and heat pumps will be restored to their previous strategies.
- The **Close**, **Ripple control**, and **EnWG 14a** DI control methods are mutually exclusive.

Step 1 Choose **Power control > DI power regulation**.

Step 2 Set the **DI control method** to **EnWG 14a**.

Step 3 Tap **Apply settings**.

--End

When the EnWG 14a mode starts operation, choose the iHomeManager from the **Device list** to go to the **General information** page. Click  next to the **DI4 signal (EnWG 14a)** measuring point to view the device operation curve under the EnWG 14a regulations.

3.3.2.2.2 Grid-Connected Power Control

Energy management mode allows users to set limits on energy purchase and feed-in power.

Step 1 Access the **Power control** page and select **Grid-connected power control**.

Step 2 Configure the following parameters.

Grid-connected power control

Data update time: 2025-01-10 16:56:39

<p style="font-size: 0.8em; color: #666;">Energy purchase control method ?</p> <div style="border: 1px solid #ccc; padding: 2px; margin-bottom: 5px;">Purchase energy with limited power ▼</div> <p style="font-size: 0.8em; color: #666;">Feed-in control method ?</p> <div style="border: 1px solid #ccc; padding: 2px; margin-bottom: 5px;">Total active power feed-in limit ▼</div> <p style="font-size: 0.8em; color: #666;">Third-party power generation systems</p> <div style="border: 1px solid #ccc; padding: 2px; margin-bottom: 5px;">On ▼</div> <p style="font-size: 0.8em; color: #666;">Ultra-fast grid dispatch mode ?</p> <div style="border: 1px solid #ccc; padding: 2px; margin-bottom: 5px;">On ▼</div>	<p style="font-size: 0.8em; color: #666;">Power limit for energy purchase</p> <div style="border: 1px solid #ccc; padding: 2px; margin-bottom: 5px;">5.50 kW</div> <p style="font-size: 0.7em; color: #666;">Range:[0 - 600.00]</p> <p style="font-size: 0.8em; color: #666;">Feed-in power limit</p> <div style="border: 1px solid #ccc; padding: 2px; margin-bottom: 5px;">0.00 kW ▼</div> <p style="font-size: 0.7em; color: #666;">Range:[-600.00 - 600.00]</p> <p style="font-size: 0.8em; color: #666;">Rated power of third-party power generation system</p> <div style="border: 1px solid #ccc; padding: 2px; margin-bottom: 5px;">0.00 kW</div> <p style="font-size: 0.7em; color: #666;">Range:[0 - 600.00]</p>
---	---

Apply settings

Parameter	Description
Energy purchase control method	<p>Available options:</p> <ul style="list-style-type: none"> • No limit • Purchase energy with limited power
Power limit for energy purchase	<p>When Purchase energy with limited power is selected, input a value in Power limit for energy purchase, which is generally based on the breaker capacity on the grid connection point. An exceedingly high value will cause overcurrent tripping, while an exceedingly low value will impact the startup of controllable loads, including the chargers.</p>
Feed-in control method	<p>Set one of the following feed-in power control methods and the corresponding values according to the requirements of the local grid company to prevent the system from feeding back more power than the settings.</p> <ul style="list-style-type: none"> • Total active power unlimited • Total active power feed-in limit • Per-phase active power unlimited • Per-phase active power feed-in limit <div style="border: 1px solid gray; padding: 10px; margin-top: 10px;"> <ul style="list-style-type: none"> • Per-phase active power unlimited and Per-phase active power feed-in limit are available only when the inverter supports power feed-in per phase. • When the options Per-phase active power unlimited and Per-phase active power feed-in limit are selected, the Peaking shaving mode under the Self-consumption energy management mode is disabled. If the Peaking shaving mode is previously on, when you apply the settings, the mode is automatically turned off. </div>
Feed-in power limit value/ratio	<p>This option is available when Feed-in control method is set to Total active power feed-in limit. You can switch the unit between kW and % to define the power limit value or ratio.</p> <ul style="list-style-type: none"> • When defining the feed-in power limit ratio, set Feed-in power limit ratio calculation basis to Nominal power or Installed PV power. When the latter is selected, specify Total installed power of modules.
Phase A/B/C feed-in power limit value/ratio	<p>When Feed-in control method is set to Per-phase active power feed-in limit, specify the feed-in power limit for each phase. You can switch the unit between kW and % to define the power limit value or ratio.</p>

Parameter	Description
Third-party power generation systems	<p>When you select On, specify Rated power of third-party power generation system.</p> <div style="border: 1px solid gray; padding: 5px; margin-top: 10px;"> <p> If a third-party inverter is connected to the system, you can define the value based on the rated power of the inverter.</p> </div>
Ultra-fast grid dispatch mode	<p>Enabling this mode allows faster active power regulation for the system. It is recommended to enable it in scenarios with reverse power protection or zero export control.</p>

Step 3 Click **Apply settings**.

--End

3.3.2.2.3 Smart Load

You can select different working modes for the connected loads on the **Smart load** tab and enable or disable them in different time periods.

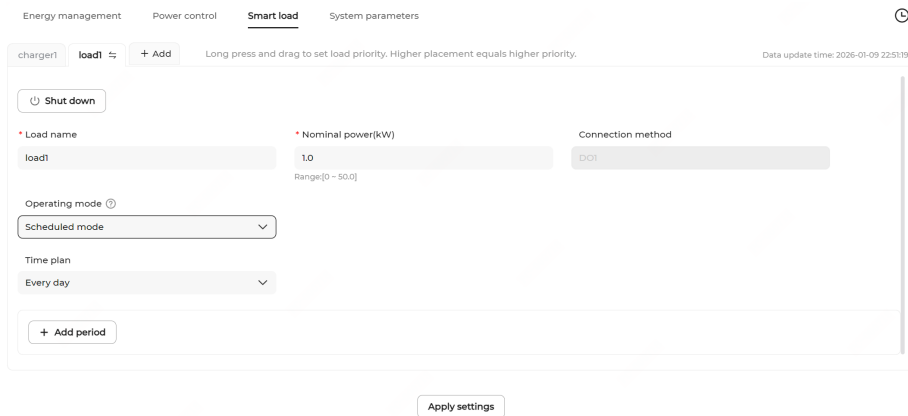

Step 1 The **Smart load** tab displays the loads already connected to the device.

Step 2 Click the sub-tab for a smart load to view and configure the corresponding parameters.

Step 3 Enter or modify the **Load name** and set the **Nominal power**.

Step 4 Set the operating mode. Options include the following.

Mode	Description
Scheduled mode	<p>Enable smart load in the user-defined time periods. After selecting the mode, define the time plan for the mode.</p> <ol style="list-style-type: none"> a. Choose Time plan to set validity for every day or on working days and non-working days. b. Click Add period and set the Start time and End time of each period.

Mode	Description
Instant mode	Enable smart load immediately.
ECO mode	<p>Enable smart load in the user-defined time periods when the allowable feed-in power exceeds the set rated power of the smart loads. If you select this mode, configure the following.</p> <ol style="list-style-type: none"> Configure Discharge prohibition SOC threshold (%), which will be used to decide whether or not to direct battery energy to compensate for the insufficient PV output. When the system SOC is above this threshold, the battery discharge is allowed to supply the charger. When the system SOC is below this threshold, the battery discharge is not allowed to supply the charger. Turn on or off Allow AI recommendation. Choose Time plan to set validity on every day or on working days and non-working days. Click Add period and set the Start time and End time of each period.

Step 5 Hold and drag the tab to adjust the load priority. The closer to the front, the higher the priority.

Step 6 Click **Apply settings**.

--End

3.3.2.3 Common Parameter Settings of Energy Management System

On the **Settings** page, select **Energy management system** from the **Device type** drop-down list, and then click  in the **Action** column for the target energy management system to configure parameters on the **Common parameter settings** window.

According to different servers, configurable parameters can vary:

- For Australian server: configurations can be made for **Energy management**, **Power control**, and **System settings** of the EMS. For detailed configuration, please see [2.3.13 Strategy Configuration](#).
- For Chinese server, European server, or International server: **Common parameter settings** can be configured. For detailed instructions, please see [3.3.2.3.1 Common Parameter Settings](#).

3.3.2.3.1 Common Parameter Settings

Common parameter settings is applicable to remote configuration of the EMS.

Step 1 Click  in the **Action** column of the EMS to access the **Common parameter settings** window.

No.	Parameter name	Value	Data range (min)	Data range (max)	Data precision	Unit	Description	Remark
1	Reset login password	Please select...	--	--	--	--	--	--
2	Remote maintenance	Please select...	--	--	--	--	--	--
3	Remote device restart	Please select...	--	--	--	--	--	--
4	Distinguish energy sources for ESS and load	Please select...	--	--	--	--	--	--
5	Release exclusive dispatch permission	Please select...	--	--	--	--	--	--
6	Upload all operation logs	Please select...	--	--	--	--	--	--
7	Update to previous (or same) version	Please select...	--	--	--	--	--	--

Step 2 You can set the following parameters on this screen:

Parameters	Description
Reset login password	You can select an EMS account and reset the password for that account.
Remote maintenance	<ul style="list-style-type: none"> • Enable: Enable remote maintenance. • Disable: Disable remote maintenance.
Remote device restart	Select Enable to allow remote device restart.
Distinguish energy sources for ESS and load	<ul style="list-style-type: none"> • Enable: Indicates that this function is enabled. Once enabled, the system will calculate the following detailed electricity data based on the energy sources and operating modes. For details, please see 5.1 Custom Report. <ul style="list-style-type: none"> - Load first statistics: ESS daily charge (from PV), ESS daily charge (from grid power), Daily load consumption (from PV), and Daily load consumption (from grid). - ESS first statistics: ESS daily charge (from PV), ESS daily charge (from grid power), Daily load consumption (ESS first_ from PV), and Daily load consumption (ESS first_ from grid). <div style="border: 1px solid gray; padding: 10px; margin-top: 10px;"> <ul style="list-style-type: none"> - This feature is available on EMS300CP-SV100.001.00.P026 or later. - The ESS electricity meter, the PV electricity meter, the gateway meter (or the load electricity meter), and the load electricity meter must be installed. </div> <ul style="list-style-type: none"> • Disable: Turn off this function.

Parameters	Description
Release exclusive dispatch permission	After Enable is selected, the third-party system that previously had exclusive dispatch will lose it, and all third-party systems will compete for dispatch permission again.
Upload all operation logs	After Enable is selected, an Upload all operation logs command will be issued to the EMS, and all command operation logs can be viewed on iSolarCloud.
Update to previous (or same) version	<ul style="list-style-type: none"> • Enable: This plant can be downgraded to a previous (same) version. • Disable: This plant can only be upgraded to a higher version.

Step 3 Click **Apply settings**. In the pop-up window, enter the **Task name**, then click **Confirm**.
--End

3.4 Firmware Update

After logging into the iSolarCloud Web system, choose **Device > Firmware update**, as shown below.

Plant Name	Device Name	Device Type	Device S/N	Device Model	Online Status	Current Version	Action
zjtest升级设置的电站	SG2KS-S_1	Inverter	--	SG3K-S	Offline	Check Version	Upgrade Refresh
zjtest升级设置的电站	SG5K-D-V36_1	Inverter	A1803241001	SG6K-D	Offline	Check Version	Upgrade Refresh
LTES1811292539的电站	SG6K-D_1	Inverter	--	SG5K-D	Offline	Check Version	Upgrade Refresh
TIME1811292541的电站	SG5K-D_3	Inverter	--	SG3K-S	Offline	Check Version	Upgrade Refresh
92544的电站	SG5K-D_3	Inverter	--	SG5K-D	Offline	Check Version	Upgrade Refresh
92544的电站	SG5K-D_3	Inverter	--	SG5K-D	Offline	Check Version	Upgrade Refresh
92544的电站	SG5K-D_3	Inverter	--	SG5K-D	Offline	Check Version	Upgrade Refresh
V1811292544的电站	SG5K-D_3	Inverter	--	SG5K-D	Offline	Check Version	Upgrade Refresh

Figure 3-4 Firmware update page



Procedure

- Search for a device
 1. Click to select the plant where the device is installed. You can select multiple plants at a time.
 2. Select the type and model of the device.

3. Enter the device S/N. You can input more than one S/N here, but make sure that they are separated by commas (.). Then, click **Search**.
- Check the device's firmware version
Click **Check version** to know the version of each module in the device.
 - Update a device
 1. Click the icon  following the device name.
 2. Choose **Online update package** or **Local update package**.
 3. Set **Single device update timeout**, and click **Update**.

For commercial and industrial (C&I) energy storage system (ESS), when the system includes the STCF series batteries (which stands for super fast charging lithium iron phosphate) and the hybrid inverter is off-grid, the device firmware update function will depend on the SOC of the included batteries.

- When the battery SOC is greater than 20%, the batteries and their connected hybrid inverter can be updated.
- When the battery SOC is lower than 20%, the firmware cannot be updated, which is to prevent the system power-off caused by insufficient energy during the update process.
- When SOC is greater than 20% in some batteries while in others, it is lower than 20%, the former batteries and their connected hybrid inverter can be updated, while the latter batteries and their connected devices cannot be updated.

- Update devices in batch
 1. Select devices of the same model, and click **Firmware update** in the upper right corner of the page.
 2. Choose **Online update package** or **Local update package**.
 3. Set **Single device update timeout**, and click **Update**.
- View task history
Click  in the upper right corner of the page to view all device update tasks for the current account.
- View the update history of a specific device
Click the icon  to view all the update tasks of the corresponding device.

4 Maintenance

After logging in to the web system, click **Maintenance** in the side navigation bar to open the page for O&M.

4.1 Curve

After logging in to the system, click **O&M** in the side navigation bar.

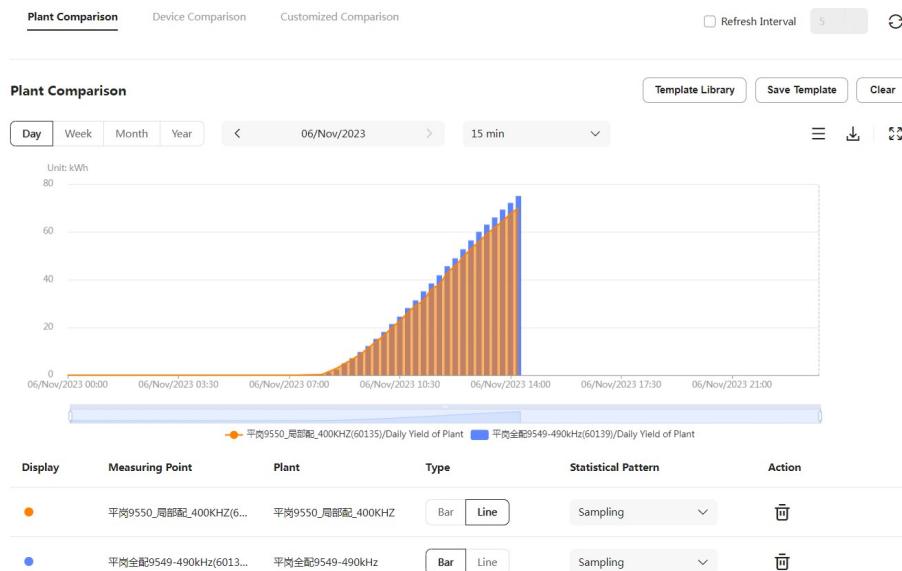

Figure 4-1 Curve

4.1.1 Plant Comparison



Plant Comparison is used to compare the measuring points of different plants.

Procedure

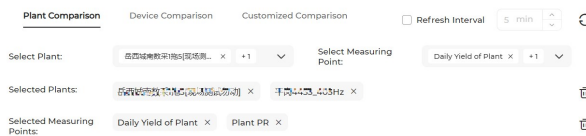
- Select plants and measuring points



- Click to select the plants and measuring points that need to be compared.
- Click following the plant or measuring point to delete it.

3. Click  to delete all the plants or measuring points that have been selected.
4. If too many plants and measuring points are selected, you can click  or  to show or hide items.
5. Click **Save Template**, enter the **Template Name**, and click **Confirm**. The template that has been saved can be viewed in **Template Library**.

Save Template
×

Template Name

Note: Once saved, templates can be viewed in the [template library](#)

Cancel
Confirm

- Apply different time periods and intervals to the curves

Day

Week

Month

Year

<

28/Jan/2024

>





15 min

▼

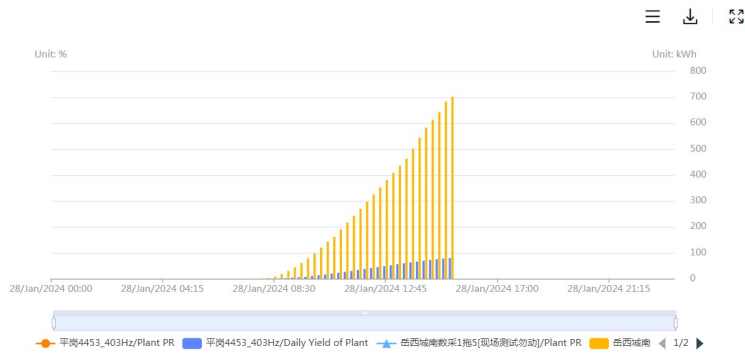
1. Click “Day”, “Week”, “Month”, or “Year” to show curves based on data collected from different time periods.
2. Click  to apply a specific time interval to the curves.

- View comparison results



1. Click  or  to show results in a table or chart.
2. In the chart view, you can click **Bar** or **Line** to switch between the bar and line graph.
3. Click  to download the data currently presented. In the table view, you can download the results in Excel or CSV format; in the chart view, you can download the results in PNG format.
4. Click  to view curves in full screen.

- Click  to exit the full-screen mode.





4.1.2 Device Comparison

Device Comparison is used to compare the measuring points of devices of the same type.

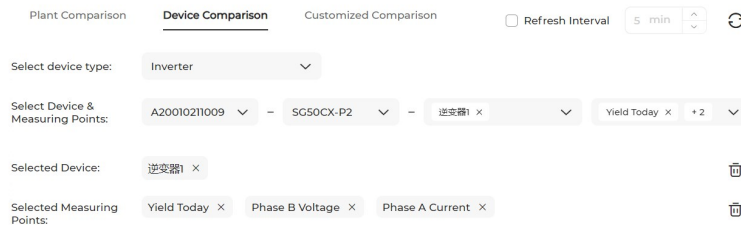



Procedure

- Select devices and measuring points

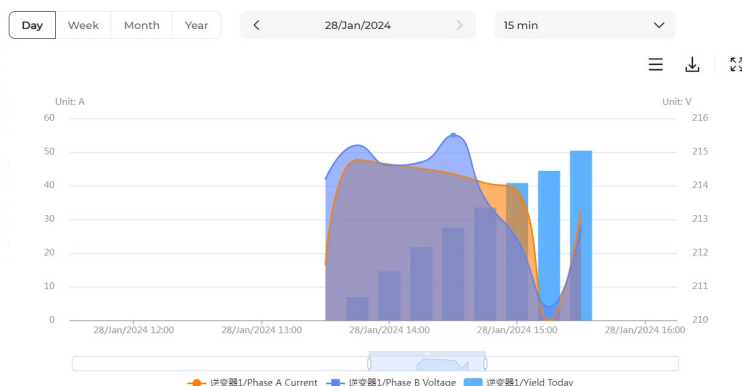

- Select the device type.
 - Select the plant where the devices are located, and the model and name of the devices.
 - Select the measuring points to be compared.
 - Click  following the device or measuring point to delete it.
 - Click  to delete all the devices or measuring points that have been selected.
 - If too many devices and measuring points are selected, you can click  or  to show or hide items.
 - Click **Save Template**, enter the **Template Name**, and click **Confirm**. The template that has been saved can be viewed in **Template Library**.
- Apply different time periods and intervals to the curves
 - Click “Day”, “Week”, “Month”, or “Year” to show curves based on data collected from different time periods.
 - Click  to apply a specific time interval to the curves.
 - View comparison results











1. Click  or  to show results in a table or chart.
2. In the chart view, you can click **Bar** or **Line** to switch between the bar and the line graph.
3. Click  to download the data currently presented. In the table view, you can download the results in Excel or CSV format; in the chart view, you can download the results in PNG format.
4. Click  to view curves in full screen.
5. Click  to exit the full-screen mode.

4.1.3 Customized Comparison

Customized Comparison is used to compare the measuring points of any plants and devices.

Procedure

- Select measuring points
 1. Click  in the plant list on the left to select the measuring points that need to be compared. You can select measuring points of any plants and devices.
 2. Click  following the measuring point to delete it.
 3. Click **Save Template**, enter the **Template Name**, and click **Confirm**. The template that has been saved can be viewed in **Template Library**.
- Apply different time periods and intervals to the curves
 1. Click “Day”, “Week”, “Month”, or “Year” to show curves based on data collected from different time periods.
 2. Click  to apply a specific time interval to the curves.
- View comparison results
 1. Click  or  to show results in a table or chart.
 2. In the chart view, you can click **Bar** or **Line** to switch between the bar and the line graph.
 3. Click  to download the data currently presented. In the table view, you can download the results in Excel or CSV format; in the chart view, you can download the results in PNG format.
 4. Click  to view curves in full screen.
 5. Click  to exit the full-screen mode.

4.2 Intelligent Analysis

The intelligent analysis function is used to analyze and show the performance of plants and devices in real time. Here you can view the analysis results in detail.

After logging into the web system, choose **O&M > Intelligent Analysis**. You will see the page shown below.

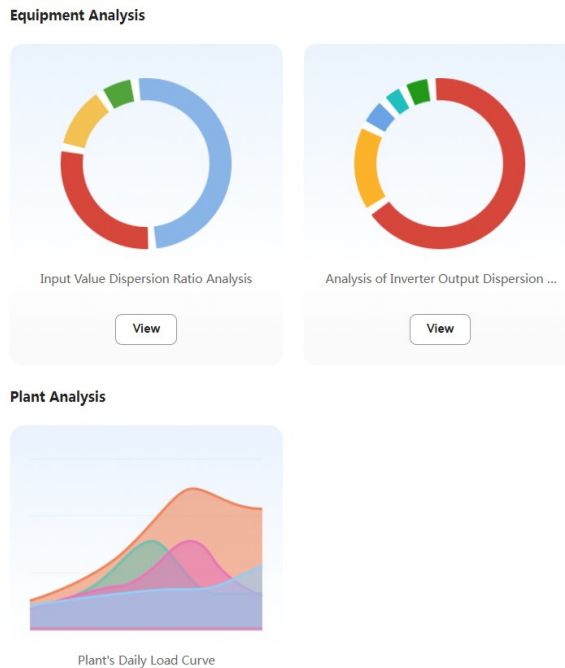

Figure 4-2 Intelligent Analysis

4.2.1 Input Value Dispersion Ratio Analysis

Click **Input Value Dispersion Ratio Analysis**, and you will go to “**Analysis of Inverter Input Dispersion Rate**” by default. Here you can check the pie chart and table generated based on the results of input value dispersion rate analysis. You can also switch to **Analysis of Combiner Box Input Dispersion Rate** to check the analysis results of the combiner box data.

Procedure

- Select a time period for data review

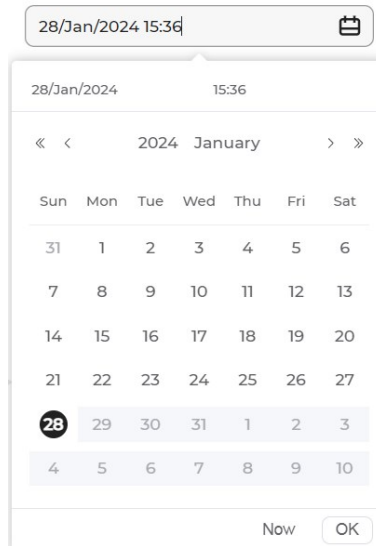

Click , and select a time period you want to review. Then, click **Confirm**.

- Download the chart of input value dispersion analysis

Click , and the dialog pops up. Select a path to save the chart, and click “Download”. The chart will then be downloaded and saved in your local system.

- Switch between “Average Current” and “Average Normalized Power”

Click  to switch between “Average Current” and “Average Normalized Power”.

- Set occlusion time for one string



1. Click  below a String x, and the dialog titled **Set Occlusion Time** will show up.

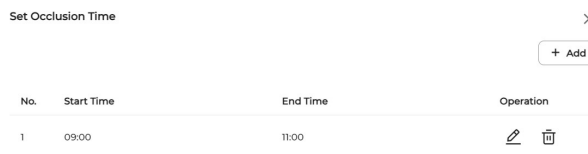

2. Click **Add**, set the **Start Time** and **End Time**, and click .

3. Proceed as follows based on the actual situation.





During occlusion time setup, avoid marking the status colors of low-power strings.

Close

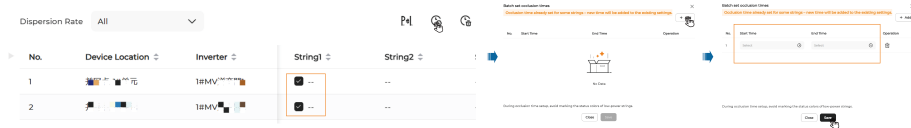
- Click **Add**, and repeat the step above.
- Click  to change the current settings.
- Click  to delete the current settings.
- Set occlusion time in batch





1. Select the strings to be set, and click  in the upper right corner of the table. A dialog titled **Batch set occlusion times** will show up.
2. Click **Add**, set the **Start Time** and **End Time**, and click **Save**.
3. Proceed as follows based on the actual situation.
 - Click **Add**, and repeat the step above.
 - Click  to delete the current settings.
- Clear the occlusion time settings in batch
 1. Select the strings, and click  in the upper right corner of the table. A dialog will then show up.
 2. Click **Confirm** to clear the settings for these strings.

4.2.2 Analysis of Inverter Output Dispersion Rate

Click **Analysis of Inverter Output Dispersion Rate**. Here you can check the pie chart and table generated based on the results of output dispersion rate analysis.

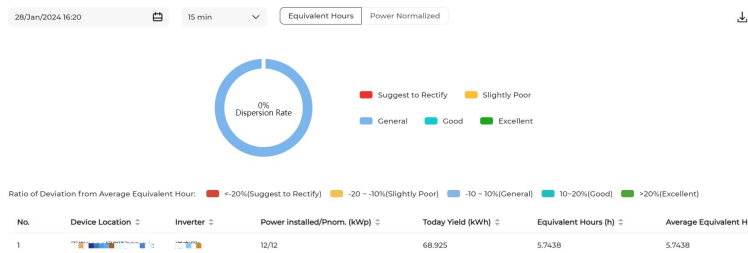
Procedure



- Select a time period for data review
 - Click , and select a time period you want to review. Then, click **Confirm**.
- Download the chart of output dispersion analysis
 - Click , and the dialog pops up. Select a path to save the chart, and click "Download". The chart will then be downloaded and saved in your local system.
- Switch between "Average Current" and "Average Normalized Power"

You can switch between **Equivalent Hours** and **Power Normalized** by clicking the corresponding tabs.

4.2.3 Plant's Daily Load Curve

Click **Plant's Daily Load Curve**. Here you can check the curves related to the plant's operating status and the fault alarms.

Procedure

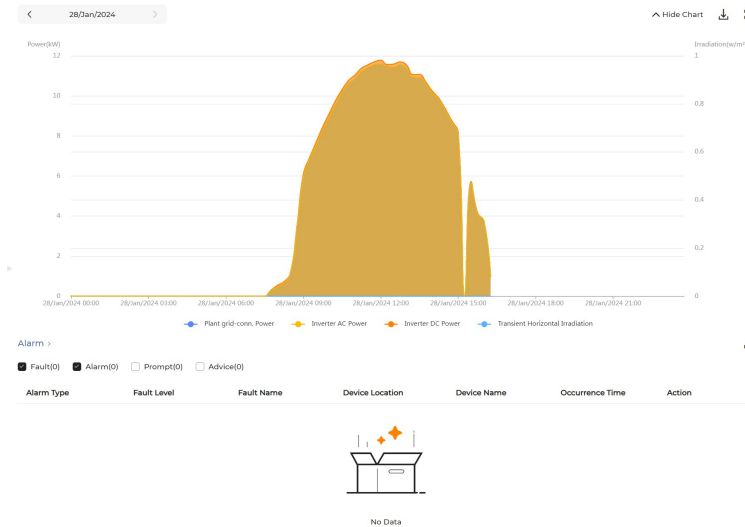

- Select a date for curve review
Click **<** and **>** to select the date for curve review.
- Hide and show the daily load curves
Click **Hide Chart** to hide the daily load curves. Click **Display Chart** to show the daily load curves.
- Download the daily load curve
Click **↓** in the upper right corner of the curve graph, and a dialog will then pop up. Select a path to save the curve graph, and click "Download". The curve graph will then be downloaded and saved in your local system.
- Download alarm information
Click **↓** in the upper right corner of the alarm list, and a dialog will then pop up. Select a path to save the alarm records, and click "Download". The alarm records will then be downloaded and saved in your local system.

4.3 Remote Maintenance

After logging into the system, choose **O&M > Remote Maintenance**. Here you can access your devices via a remote link.

Device Name	Device S/N	LAN address	HTTP remote connection address	TCP remote connection address
e789439f09f	CG666888	127.0.0.1:80	http://e789439f09f.testconn...	
5fc699908a4	T201803200033	127.0.0.1:80	http://5fc699908a4.testconn...	
ab80cfb04c4	Y2009816315	127.0.0.1:80	http://ab80cfb04c4.testconn...	
c1a2769c713	ZCS20201121	127.0.0.1:80	http://c1a2769c713.testcon...	

Figure 4-3 Remote Maintenance

Procedure

- Select the plant, enter Device S/N, and click **Search** to look for the device.
- Click the link in **HTTP remote connection address** to open it directly.
- You can click  to copy the link.



The remote maintenance function is available for EyeM4, Logger1000, Logger3000, and Logger4000 only.

4.4 Live data

Users granted access to “Live Data” can use it to evaluate the operating status of the device based on the real-time device data.

After logging in to the system, choose **O&M > Live Data**. You will see the page shown below.

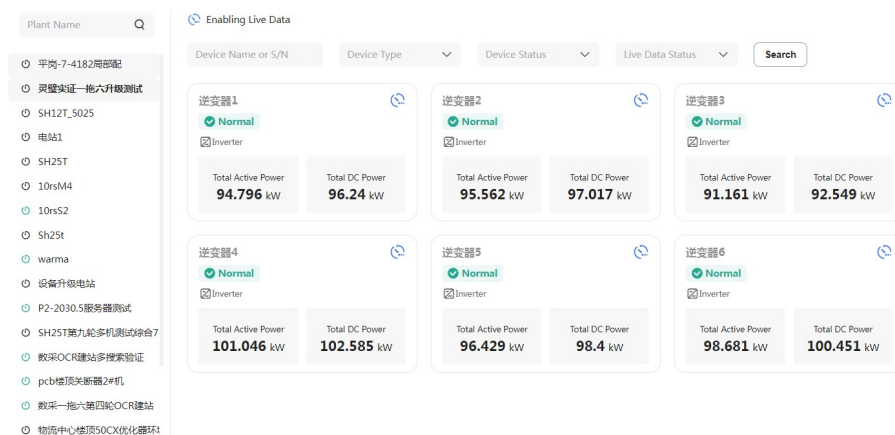



Figure 4-4 Live data

Procedure

- Enable live data
 1. Choose a plant you want to review in the plant list on the left. You may also enter the plant name in the search box at the top of the list to look for the plant.
 2. In the search boxes, enter **Device Name or S/N**, select the **Device Type**, **Device Status**, **Live Data Status**, and click **Search** to show devices that meet the search criteria.
- View live data
 1. Click the device card, and you will go to the **Main Measuring Point** tab page by default.
 2. Click  following a measuring point to view its curve.
 3. Click **AC Curve** to view the phase voltage and current curves.

4.5 IV Curve Online Diagnosis

This function is used to perform online IV curve diagnosis. By applying the diagnosis algorithm and through analysis, the faulty module can be located automatically, and diagnosis report and O&M suggestions will be provided. It can help to improve the O&M efficiency and the yield of the plant.

After logging in to the web system, choose **O&M > IV Curve Online Diagnosis**. Here you can run an online diagnosis on modules in the plant at unit level or inverter level. The interface is shown below.

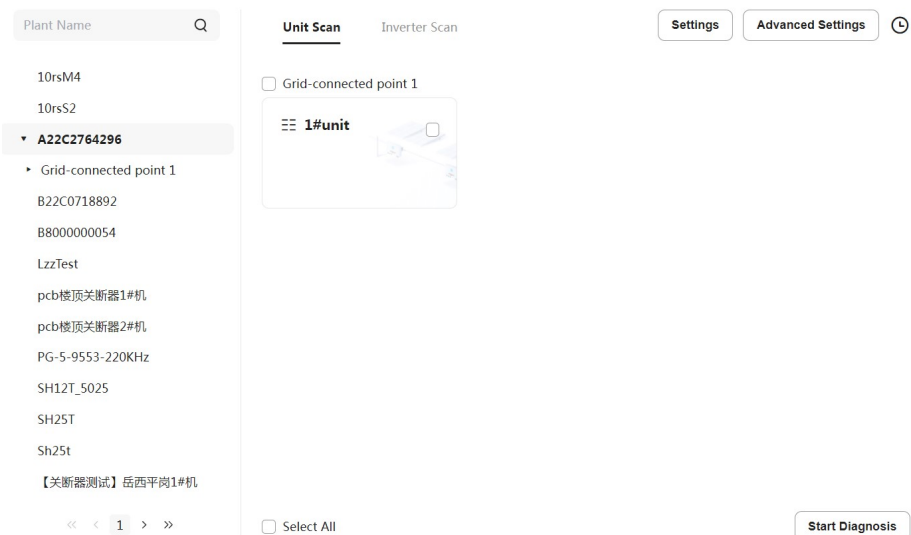

Figure 4-5 IV Curve Online Diagnosis

4.5.1 Parameter Setting

Click **Settings** in the upper right corner, and you will then go to **Settings**. You need to complete the settings in **Plant Parameter** and **Inverter Parameters** before performing the IV curve diagnosis for the first time.

Procedure

- Set plant parameters





Plant Parameter
Inverter Parameters
PV Module Management

Plant Terrain





String orientation is consistent ▼

Selecting power plant topography ▼

String orientation is consistent
Lay components along flat ground, flat roofs, single-pitched roofs or in a specific direction on complex pitched roofs.







String orientation is inconsistent
Example: Lay components along hills, double-pitched roofs, quadruple-pitched roofs, mansard roofs or other such surfaces.

Cancel
Confirm

Select **String orientation is consistent** or **String orientation is inconsistent** in "Plant Terrain" based on the actual situation.

- Set parameters for one inverter
 1. Find the target inverter, and click  in the Action column.
 2. Select the **Module Model** and **Initial Commissioning Time of PV Modules**.

String Configuration Information

* Module Model

Please Select

* Initial Commissioning Time of PV Modules

Please Select



3. If the Y-type branch connector is used on the site, turn on the "Branch Connector" toggle button. If the number of modules connected to each string is different, please set the number of modules for each string separately. If the field is set to "0" or left empty, it indicates no module is connected.

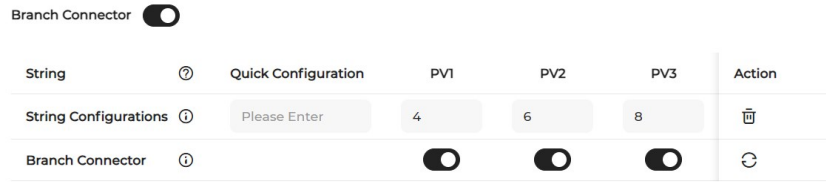

Figure 4-6 Strings have different number of modules

4. If the Y-type branch connector is not used on the site, turn off the "Branch Connector" toggle button. If the strings all have the same number of modules, you can enter the number of modules connected to each string in "Quick Configuration", and this value will then be auto-filled in the fields of all PV strings.



Figure 4-7 Strings have the same number of modules

5. Click **Confirm**.
- Set parameters for a group of inverters
 1. Select inverters of the same model, and click **Batch Settings**.
 2. For the rest of the steps, refer to the instructions for setting a single inverter.

4.5.2 Advanced Settings

Select a plant on which you want to perform IV curve scanning from the plant list on the left. Click **Advanced Settings** in the upper right corner of the page.

Procedure

U-system(V)	Parameters	Parameter Name	Parameter Value	Action
1000	1000		1,000	
1000	123		987	
1000	AzimuthTimeThrd		30	
1000	LowImThre		0.8	
1000	shadowThreU		0.5	
1000	ShadowThreD		0.3	
1000	PsIntervalThre		0.5	

- Search for advanced parameter settings
Set **U-system**, enter the parameter and its name, and then click **Search**. Parameters that meet the search criteria will then be shown on the screen.
- Add a parameter
 1. Click **Add** in the upper right corner.

2. Select the **U-system**, enter the **Parameter**, **Parameter Name**, and **Parameter Value**, and then click **Confirm**.

Add
×

U-system
1000V

* Parameters
Please Enter

* Parameter Name
Please Enter

* Parameter Value
Please Enter

If the value is obtained through other parameter calculation, # should be added before and after other parameters, eg.: 3*#smoothNum#

Cancel
Confirm

3. A message box will show up, saying that your settings have been saved successfully. Click **Confirm**.
- Modify a parameter

1. Click  in the Action column.
2. Here you can change the **Parameter Name** and **Parameter Value**, and choose whether to apply this change to all plants. Then, click **Confirm**.

Modify
×

U-system
1000V

* Parameters
123

* Parameter Name
1027

* Parameter Value
987

If the value is obtained through other parameter calculation, # should be added before and after other parameters, eg.: 3*#smoothNum#

Apply to all plants

No Yes

Cancel
Confirm

3. A message box will show up, saying that your settings have been saved successfully. Click **Confirm**.
- Delete a parameter
 - Click  in the Action column. In the popped-up deletion confirmation dialog, click **Confirm**.
 - A message box will show up, saying that the parameter has been deleted. Click **Confirm**.

4.5.3 Unit Scan

Prerequisite

You cannot perform IV curve scanning on an offline plant.

The unit scan function is not available for residential PV and residential energy storage plants.

- Step 1** Select the plant, on which you want to perform IV curve scanning, from the list. You will then go to the **Unit Scan** tab. Inverters in the plant will all be scanned by default.

Step 2 Select the unit, and click **Start Diagnosis** in the lower right corner. The system will verify whether settings of device parameters have been completed. If the parameters have not been set, a prompt will show up. Click **Complete Them Now**. For details, see [4.5.1 Parameter Setting](#).

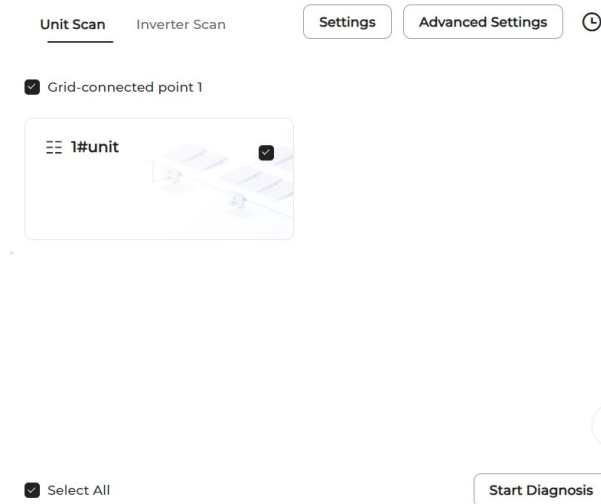

Step 3 Enter the task name, and click **Confirm**.

Step 4 Once the command is sent out, the scanning status will be refreshed in real time, with diagnosis progress showing at the bottom of the screen.

Step 5 After the scan is complete, click **Diagnosis Results** to check the result.

Step 6 The diagnosis result and the number of abnormal strings will be presented in the upper half of the page.

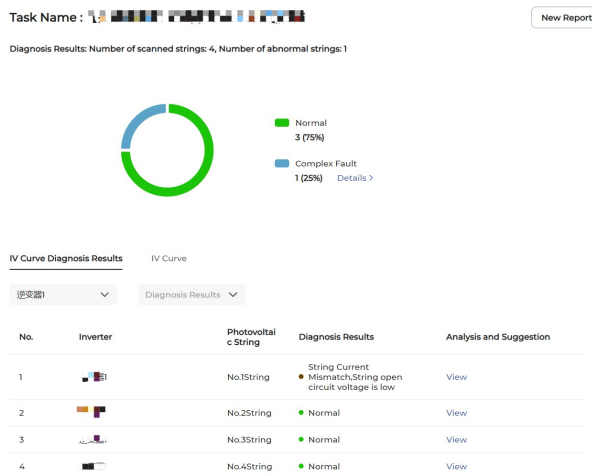

Step 7 Click **New Report**, select the report type and device, and click **Confirm**. You will then go to the report list automatically. You can click to preview the diagnosis report online. Click to download the diagnosis report to your local system.

--End

4.5.4 Inverter Scan

- Step 1** Select the plant, on which you want to perform IV curve scanning, from the list. You will then go to the **Unit Scan** tab by default.
- Step 2** Choose **Inverter Scan**. You can have one or multiple inverters scanned.
- Step 3** Select the inverter, and click **Start Diagnosis** in the lower right corner. The system will verify whether settings of device parameters have been completed. If the parameters have not been set, a prompt will show up. Click **Complete Them Now**. For details, see [4.5.1 Parameter Setting](#).
- Step 4** For other steps, see Step 3 to 7 in [4.5.3 Unit Scan](#).

--End

4.6 Fault Response Plan

With this function, when the plant detects faults, the system will send alarm notifications to users. It can be configured by installers only.

Click **Maintenance > Fault response plan** for details. The page displays the response plans that have already been added. You can modify and delete them via the icons in the **Action** column.

This section introduces how to add fault response plans.

- Step 1** Click **Add** in the upper right corner of the page.

- Step 2** Enter a **Plan name**.

- Step 3** Select a plant for the new plan. You can select multiple plants.

Step 4 Choose the device types that require the response plan and tick the relevant faults, alarms, and advise.

 Some types are not visible to owners and the actual page shall prevail.

Step 5 Add the personnel who will receive the notifications, through the button **Custom** or **Select personnel**. The added personnel will be displayed in the list.

- Custom: Add notification recipients by yourself.

- Click **Custom**.
- In the pop-up window, select the sending language and the contact name.
- Choose the reminder method of either **SMS** or **Email**, enter the **Mobile phone number** or **Email**, and fill in the corresponding **Verification code**.
To add multiple phone numbers or email addresses to be notified, click **Add**.
- Click **Confirm**.

- Select personnel: select the persons whose information has already been defined.

<input type="checkbox"/>	Personal name	Mobile phone number	Email	Reminder method
<input type="checkbox"/>	XXXXXXXXXX	XXXXXXXXXX	XXXXXXXXXX@XXXXXX	<input type="checkbox"/> App push <input type="checkbox"/> SMS <input type="checkbox"/> Email
<input type="checkbox"/>	XXXXXXXXXX	--	XXXXXXXXXX	<input type="checkbox"/> App push <input type="checkbox"/> Email
<input type="checkbox"/>	XXXXXXXXXX	--	--	<input type="checkbox"/> App push
<input type="checkbox"/>	XXXXXXXXXX	--	--	<input type="checkbox"/> App push
<input type="checkbox"/>	XXXXXXXXXX	--	--	<input type="checkbox"/> App push

- Click **Select personnel**.

- b. You can search by the organization and the personnel name to obtain an expected list.
 - c. In the list, choose the personnel to be notified and the **Reminder method**, including App push, SMS, and email. SMS and email are only supported for those whose phone numbers and email addresses have been added.
- Click **Confirm**.

Step 6 Click **Confirm**. Once completed, the settings will take effect within 30 minutes.

--End

4.7 Plant Operation Report

After logging in to the Web, go to the Home page and choose **Maintenance > Plant operation report**. On this page, you can export the operation report of a plant.

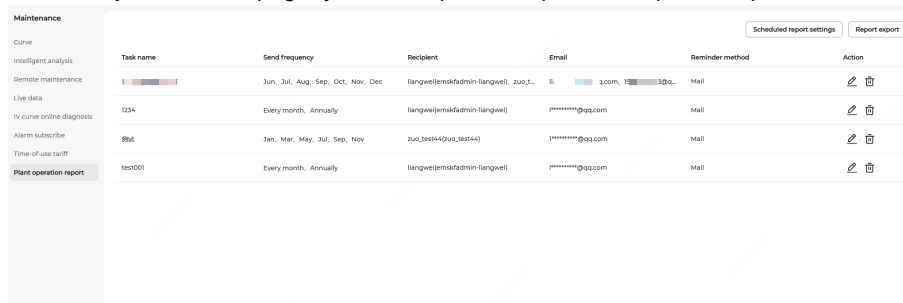

Task name	Send frequency	Recipient	Email	Reminder method	Action
1	Jun, Jul, Aug, Sep, Oct, Nov, Dec	liangwei@emsadmin-liangwei.com	liangwei@emsadmin-liangwei.com	Mail	
1234	Every month, Annually	liangwei@emsadmin-liangwei.com	liangwei@emsadmin-liangwei.com	Mail	
888	Jan, Mar, May, Jul, Sep, Nov	zuo38044@zuo38044.com	zuo38044@zuo38044.com	Mail	
test001	Every month, Annually	liangwei@emsadmin-liangwei.com	liangwei@emsadmin-liangwei.com	Mail	

Step 1 On the **Plant operation report** page, a list of report export tasks is displayed.

Step 2 Click **Scheduled report settings** or **Report export** in the upper right corner.

- Scheduled report settings: Send reports periodically based on the selected plant and time.

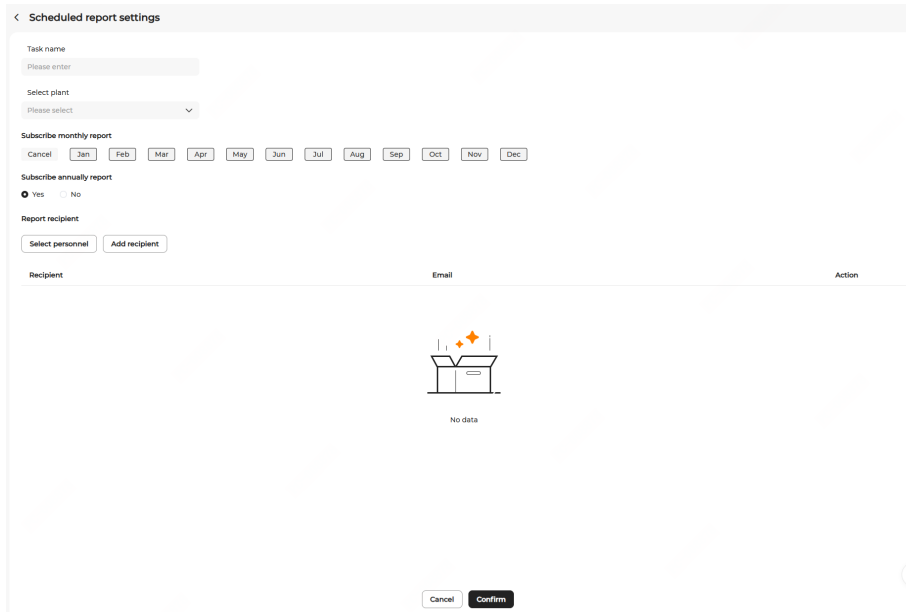

Scheduled report settings

Task name
Please enter

Select plant
Please select

Subscribe monthly report
Cancel Jan Feb Mar Apr May Jun Jul Aug Sep Oct Nov Dec

Subscribe annually report
 Yes No

Report recipient
Select personnel Add recipient

Recipient	Email	Action
<p>No data</p>		

Cancel Confirm

- a. Click **Scheduled report settings** in the upper right corner of the page.
- b. Enter the **Task name**
- c. Click  to select plants (multiple selections are supported).
- d. Configure the settings for **Subscribe monthly report**, **Subscribe annual report**, and **Report recipient**.



A maximum of 20 recipients can be selected.

- e. To edit the information of a recipient, click  in the **Action** column for that recipient.
 - f. Click **Confirm**.
- Report export: Export the operation report of the selected plant immediately.

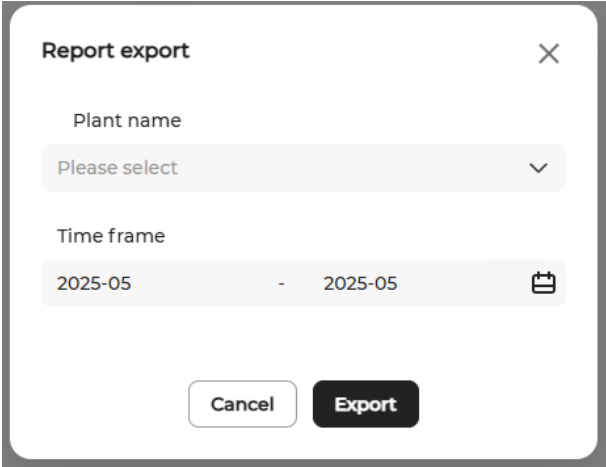

- a. Click **Report export** in the upper right corner.
- b. Click  to select a plant.
- c. Select a **Time frame**.



The selected time frame cannot exceed 1 year.

- d. Click **Export** to download the report to your local system.

Step 3 To edit the information of an export task, click  in the **Action** column for that task.

Step 4 To delete an export task, click  in the **Action** column for that task.

--End

5 Report

After logging in to the web system, click **Report** in the side navigation bar to view, export, and subscribe to reports. The system offers a selection of default reports and allows you to create custom reports by selecting the indicators you need.

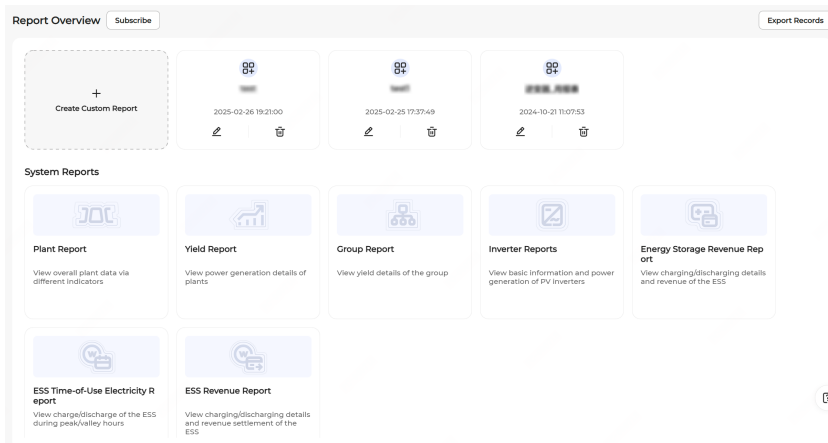

5.1 Custom Report

Create a Custom Report

Procedure

1. Click **Create Custom Report** in the upper left corner to access the **Create New Report** page.

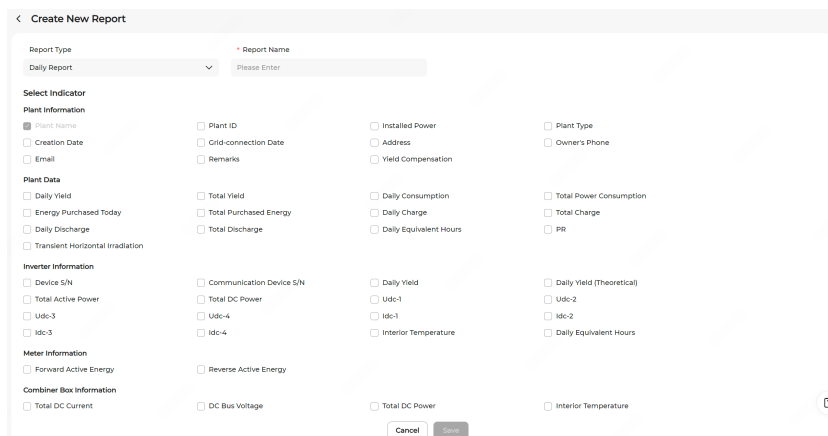

2. Select the **Report Type**, enter a **Report Name**, and choose desired report indicators.



Report Name Requirements: Names must be unique under each user account, not exceed 20 characters, and avoid special characters.

3. Click **Save > Confirm**. The report will be created and displayed on the **Report Overview** page.

Edit a Custom Report

Procedure

1. Click to access the **Custom Report** page.
2. Modify the **Report Type**, **Report Name**, or the selected indicators as needed.
3. Click **Save > Confirm** to confirm the changes.

Delete a Custom Report

Procedure

- Click > **Delete** to delete the report.

Use a Custom Report

Procedure

1. Click on an existing custom report to view it.

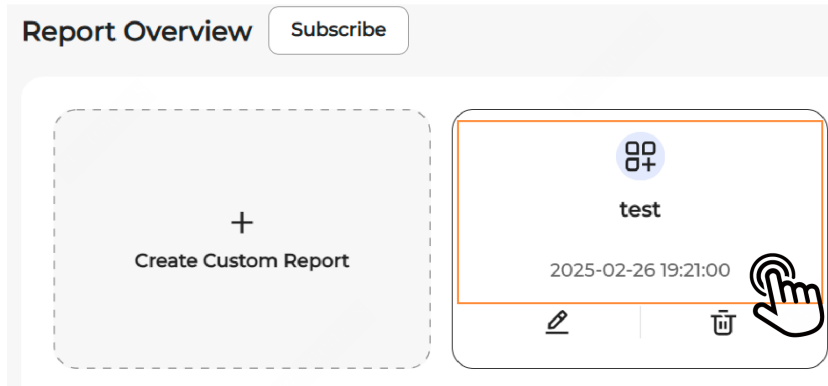

2. Select a plant (or multiple plants) in the plant list on the left. The report data for selected plants will populate on the right. You can click **Clear** to reset your selections.

Plant Name	Time	Daily Yield(\$/kWh)	Total Yield(\$/kWh)	Plant Information
				Daily Consumption(\$/kWh) Total Power Consumption(\$/kWh)
...	2025-02-26 00:00
...	2025-02-26 01:00
...	2025-02-26 02:00
...	2025-02-26 03:00
...	2025-02-26 04:00
...	2025-02-26 05:00
...	2025-02-26 06:00
...	2025-02-26 07:00
...	2025-02-26 08:00
...	2025-02-26 09:00
...	2025-02-26 10:00
...	2025-02-26 11:00

Export a Custom Report

Procedure

- Click **Export** and choose either **Export As Excel** or **Export As CSV** to export the current report. An export record will be displayed on the **Export Records** page.

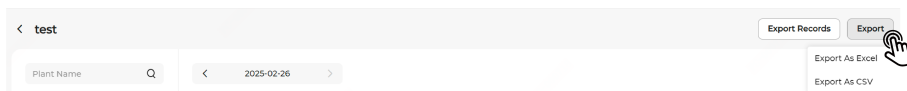

5.2 System Reports

The platform supports the following predefined system reports:

- Plant report: View overall plant data via different indicators.
- Yield report: View total yield details of plants.
- Inverter report: View basic information and power generation details of PV inverters.
- Energy storage revenue report: View charge/discharge details and revenue of the ESS.
- ESS revenue report: View charge/discharge details and revenue settlement of the ESS.

- ESS time-of-use energy report: View charge/discharge details of the ESS during peak/valley hours.
- ESS demand revenue report: View ESS revenue details after enabling the demand strategy.

5.2.1 Plant Report

The Plant Report provides an overview of plant data across various metrics.

Procedure

1. Click **Plant Report** on the **Report Overview** page.

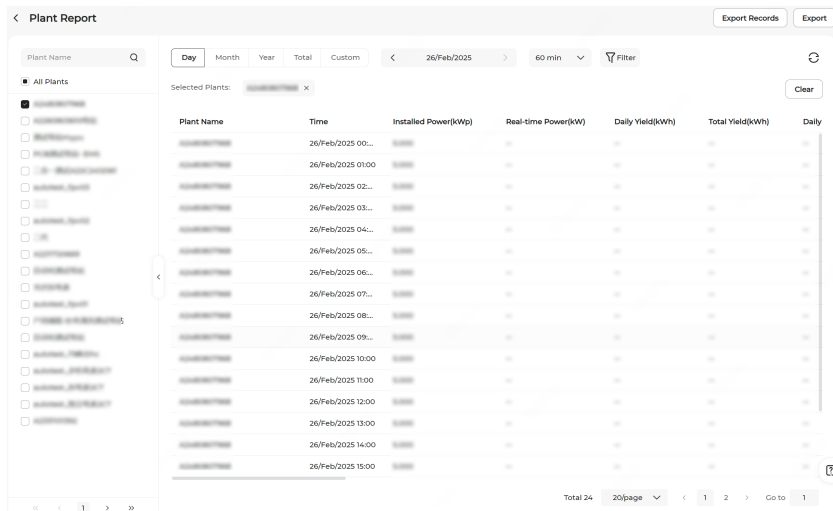

The screenshot shows the 'Plant Report' interface. On the left, there is a list of plants under 'All Plants'. The main area displays a table with columns: Plant Name, Time, Installed Power(kWp), Real-time Power(kW), Daily Yield(kWh), Total Yield(kWh), and Daily. The table shows data for a plant named 'SUNGROW' for the date 26/Feb/2025, with time intervals from 00:00 to 15:00. The table is filtered to show 24 records, with 20 records visible on the current page.

Plant Name	Time	Installed Power(kWp)	Real-time Power(kW)	Daily Yield(kWh)	Total Yield(kWh)	Daily
SUNGROW	26/Feb/2025 00:00	10000				
SUNGROW	26/Feb/2025 01:00	10000				
SUNGROW	26/Feb/2025 02:00	10000				
SUNGROW	26/Feb/2025 03:00	10000				
SUNGROW	26/Feb/2025 04:00	10000				
SUNGROW	26/Feb/2025 05:00	10000				
SUNGROW	26/Feb/2025 06:00	10000				
SUNGROW	26/Feb/2025 07:00	10000				
SUNGROW	26/Feb/2025 08:00	10000				
SUNGROW	26/Feb/2025 09:00	10000				
SUNGROW	26/Feb/2025 10:00	10000				
SUNGROW	26/Feb/2025 11:00	10000				
SUNGROW	26/Feb/2025 12:00	10000				
SUNGROW	26/Feb/2025 13:00	10000				
SUNGROW	26/Feb/2025 14:00	10000				
SUNGROW	26/Feb/2025 15:00	10000				

2. Select a plant (or multiple plants) in the left-side plant list to view the corresponding report data.
3. You can perform the following actions as needed:
 - a. Click **Day**, **Month**, **Year**, **Total**, or **Custom** and set the time and time interval. You can then view the plant's daily, monthly, annual, overall, or custom time reports.
 - b. Click **Filter** to open the indicator selection panel on the right. Choose specific indicators and click **Confirm** to refine the report.

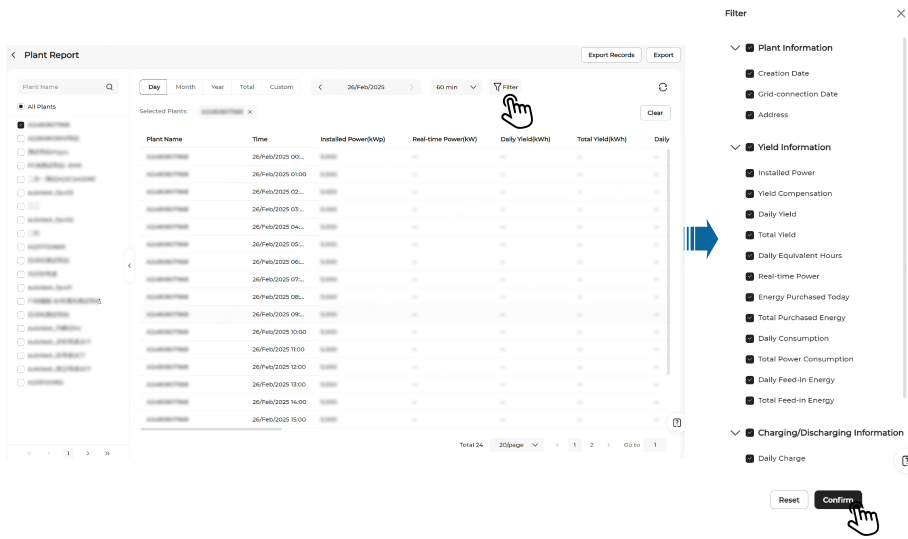

- c. Click **Clear** to reset your selections.
- d. Click **Export** and choose either **Export As Excel** or **Excel As CSV** to export the current report. An export record will be displayed on the **Export Records** page.

5.2.2 Yield Report

The Yield Report offers detailed yield data for each plant.

Procedure

1. Navigate to **Report Overview** and click **Yield Report**.
2. Select a plant (or multiple plants) in the left-side plant list to view its yield report accordingly.

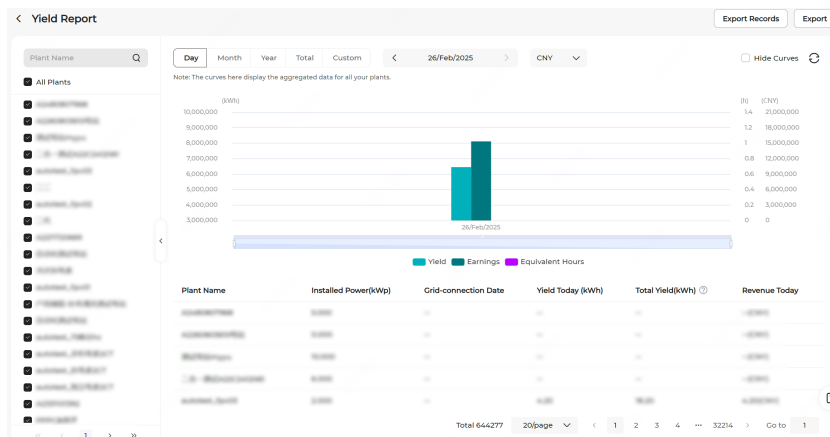

3. You can perform the following actions as needed.
 - a. Choose from Day, Month, Year, Total, or Custom and specify the desired time span to view the report as needed.

- b. View IV curve graphs. By default, the plants are all selected and curves for all plants are displayed. You can click **Hide Curves** in the upper right corner to hide the curves.
- c. Click **Export** and choose either **Export As Excel** or **Excel As CSV** to export the current report. An export record will be displayed on the **Export Records** page.



The curve graphs displayed on the report page will be included in the exported report file.

5.2.3 Inverter Report

The Inverter Reports provide the basic information about the PV inverters and their detailed yield data.

Procedure

1. Navigate to **Report Overview** and click **Inverter Reports**.
2. Select a plant (or multiple plants) in the left-side plant list to view its inverter report accordingly.

Plant Name	Device Model (SN)	Communication Device SN	Daily Yield (kWh)	27/Feb/2025 00:00	27/Feb/2025 01:00	27/Feb/2025 02:00	27/Feb/2025 03:00
...	Offline: SG110CK-P...
...	SG106TX

3. You can perform the following actions as needed.
 - a. Choose from Day, Month, Year, Total, or Custom and specify the desired time span to view the report as needed.
 - b. Click **Clear** to reset your selections.
 - c. Click **Export** and choose either **Export As Excel** or **Excel As CSV** to export the current report. An export record will be displayed on the **Export Records** page.

5.2.4 ESS Time-of-Use Electricity Report

The ESS time-of-use electricity reports allow you to view charge/discharge of the ESS during peak/valley hours based on different indicators.

Step 1 Navigate to the **Report overview** page and click **ESS time-of-use electricity report**.

ESS time-of-use electricity report

Export records Export

Plant name Month Year Total < May 2025 > Filter

All plants

Selected plants: 光储充一体示范站2

Plant name	Time	Charge(kWh)						Discharge(kWh)					
		Tip	Peak	Flat	Valley	Deep valley	Total	Tip	Peak	Flat	Valley	Deep valley	Total
光储充一体示范站2	01/May/2025	0.00	22.00	18.00	0.00	0.00	40.00	0.00	24.00	30.00	0.00	0.00	54.00
光储充一体示范站2	02/May/2025	0.00	17.00	24.00	19.00	0.00	60.00	0.00	43.00	19.00	0.00	0.00	62.00
光储充一体示范站2	03/May/2025	0.00	32.00	31.00	27.00	0.00	90.00	0.00	26.00	39.00	21.00	0.00	86.00
光储充一体示范站2	04/May/2025	0.00	29.00	32.00	30.00	0.00	91.00	0.00	49.00	19.00	0.00	0.00	68.00
光储充一体示范站2	05/May/2025	0.00	14.00	19.00	17.00	0.00	50.00	0.00	0.00	30.00	0.00	0.00	30.00
光储充一体示范站2	06/May/2025	0.00	3.00	17.00	1.00	0.00	21.00	0.00	7.00	1.00	0.00	0.00	19.00

Step 2 Select a plant (or multiple plants) in the left-side plant list to view the corresponding report data.

Step 3 You can perform the following actions as needed:

- Click "Month", "Year", or "Total" and set the time and time interval. You can then view the plant's monthly report, annual report, or overall report.
- Click **Filter** to open the indicator selection panel on the right. Choose specific indicators and click **Confirm** to view the target information.

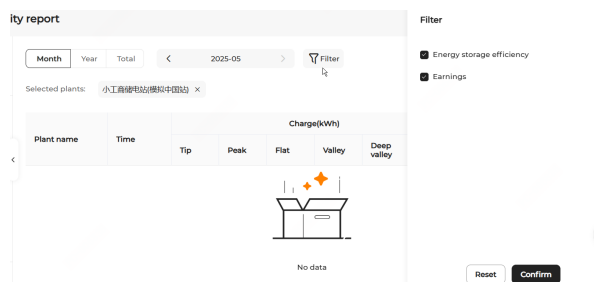

Step 4 Click **Clear** to reset selections.

Step 5 Export reports. Click **Export** and select **Export as Excel** or **Excel as CSV** to export the current report. An export record will be displayed on the **Export records** page.

--End

5.2.5 ESS Revenue Report

The ESS revenue reports allow you to view charging/discharging details and revenue settlement of the ESS.

Step 1 Navigate to the **Report overview** page and click **ESS revenue report**.

Revenue type	Time interval	Mains electricity price(CNY/kWh)	Charging/discharging	Electrical energy(kWh)	Electricity bill(CNY)	Total(CNY)
Critical peak hours	0		Charge	0	0	
	0		Discharge	0	0	
Peak hours	1.1865		Charge	177	-138.8205	
	1.1865		Discharge	149	176.7885	
Peak-valley arbitrage	0.7093		Charge	141	-100.0113	
	0.7093		Discharge	138	97.8934	14.9183
Valley hours	0.2866		Charge	54	-26.9404	
	0.2866		Discharge	21	6.0196	
Deep valley period	0		Charge	0	0	
	0		Discharge	0	0	
Total						14.9183

Step 2 Select a plant in the left-side plant list to view the corresponding report data.

Step 3 Click the calendar icon marked by the rectangular red box, as shown in the following figure, to select a target period.

Revenue type	Time interval	Mains electricity price(CNY/kWh)
Critical peak hours		0
		0
Peak hours		1.1865
		1.1865
Peak-valley arbitrage	Shoulder hours	0.7093
		0.7093
Valley hours		0.2866
		0.2866
Deep valley period		0
		0

Step 4 Click **Export** to export the report. An export record will be displayed on the **Export records** page.

--End

5.2.6 ESS Demand Revenue Report

The ESS demand revenue report allows you to view the revenue generated after enabling the **Demand control** or **Grid-connected power control** strategy.

This function is applicable under the following conditions:

- This function is only applicable to C&I ESS plants using EMS300CP as the controller.

- The **Demand control** or **Grid-connected power control** strategy must be **enabled** in EMS300CP. (The **Energy purchase control method** must be set to **Purchase energy with limited power** or **Dynamic power purchase threshold**.)
- This function is available on EMS300CP-SV100.001.00.P028 or later.

Step 1 Navigate to the **Report overview** page and click **ESS demand revenue report**.

Step 2 Select a plant in the left-side plant list to view the corresponding report data.

Step 3 Click the 2026-02-01 - 2026-02-08  icon to select a target period.

Step 4 Click **Export** to export the report. An export record will be displayed on the **Export records** page.

--End

5.3 Export Records

The reports exported within the past three days are displayed on the Export Records page. In the upper right corner of the **Report Overview** page:

- If an export task is in progress: The number of reports being exported will be shown. For example, **"1/3"** indicates that three reports are being exported, with one successfully completed. You can click **View** to access the Export Records page.

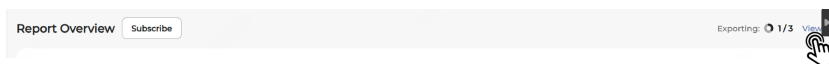

- If no export task is in progress: You can click **Export Records** to go to the Export Records page.

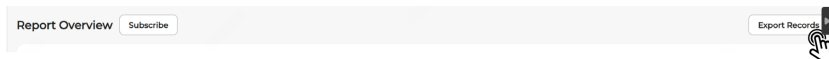

- For a successfully exported report, you can click  in the Action column to re-download it.
- For an ongoing export task, the estimated remaining time will be shown in the Status column.

5.4 Report Subscription

You can click **Subscribe** on the **Report Overview** page to create, view, and edit your report subscriptions.

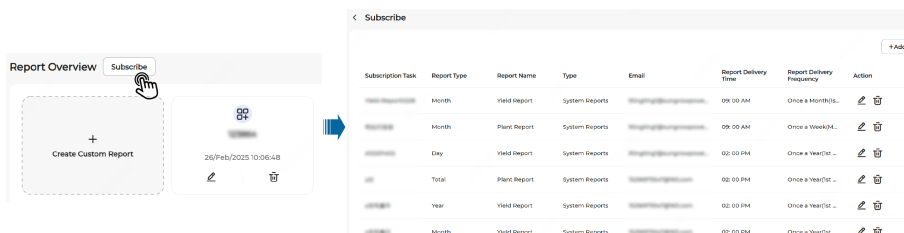

You can select the report type and time span, and subscribe to receive the reports via email. The reports will be sent at regular intervals and can be viewed and downloaded.

Procedure

- Add a Subscription

1. Click **Add** to go to the **Add Subscriptions** page.

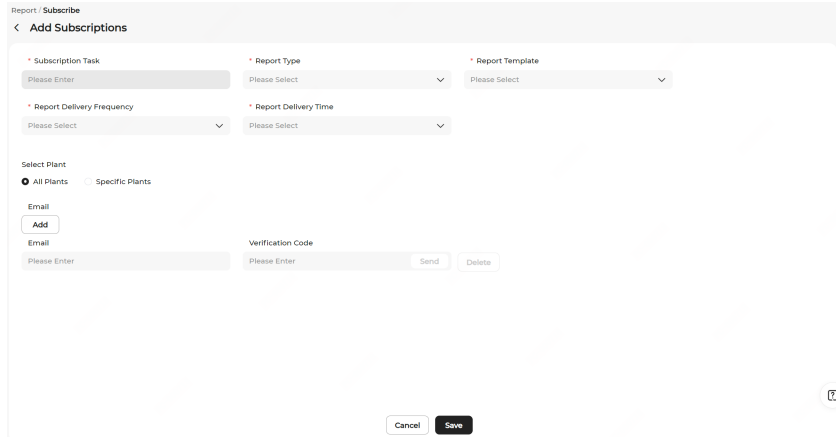

2. Complete the below settings:

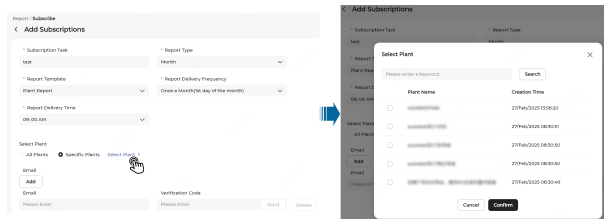

- Subscription Task: Name the subscription task.
- Report Type: Select Day, Month, Year, or Total.
- Report Template.
- Report Delivery Frequency: Select Once a Day, Once a Week (Monday), Once a Month (first day of the month), or Once a Year (January 1).
- Report Delivery Time: Select 09:00 AM, 02:00 PM, or 07:00 PM.
- Select Plant: Choose **All Plants** or **Specific Plants**. If you select **Specific Plants**, click **Select Plant** to select the plants you need.



- Email: Enter the email address where you would like to receive reports.
 Verification Code: Click **Send** to send a verification code to the provided email address. Then, enter the received verification code here.
 Add more email addresses: Click **+Add** to add more email addresses. Up to 10 emails can be added.

3. Click **Save** to save the settings.

- Edit a Subscription

1. Select a subscription task and click  in the Action column to access the edit page.
 2. Modify the settings and click **Save > Confirm** to apply the changes.
- Delete a Subscription
- Select a subscription task and click  in the Action column to delete it.

6 System

After logging in to the iSolarCloud Web, click **System** in the left sidebar for details.

6.1 Plant Sharing

This function enables you to share the plant with other users in the system for browsing and managing.

Step 1 After logging in to the iSolarCloud Web, navigate to **System > Plant sharing > Available plants for sharing**.

<input type="checkbox"/>	Plant name	Plant type	Sharing status	Creation time	Organization	Contact information	Plant address	Action
<input type="checkbox"/>		C&I ESS	Not shared	2026-03-09 08:17:38		--		
<input type="checkbox"/>		C&I ESS	Not shared	2026-03-09 08:17:37		--		
<input type="checkbox"/>		C&I ESS	Not shared	2026-03-09 08:17:15		--		
<input type="checkbox"/>		C&I ESS	Not shared	2026-03-08 08:17:32		--		
<input type="checkbox"/>		C&I ESS	Not shared	2026-03-08 08:17:30		--		
<input type="checkbox"/>		C&I ESS	Not shared	2026-03-08 08:17:07		--		
<input type="checkbox"/>		C&I ESS	Not shared	2026-03-07 13:36:14		--		

Step 2 To quickly search for the plants to share, define **Plant type**, **Plant name**, **Device S/N**, or **Creation date (start date) - Creation date (end date)**, and click **Search**.

Step 3 Click the icon in the **Action** column of the available plants for sharing to open the **Share** page. Alternatively, select multiple plants in a batch and choose the button **Batch share**.

Step 4 Click **Add user**, enter the iSolarCloud-bound email of the user, with whom you want to share the plant in Email, and assign permissions in **Access permission** accordingly.

- Viewers: Allowed to view plant data only.
- Administrators: Allowed to view plant data and configure and manage the plant operation.

Step 5 Click the icon to add more users.

Step 6 To remove an added user, click the icon  in the **Action** column to delete the user from the sharing list.

Step 7 Click **Confirm** to share the plant.

--End

View **Plants shared with me**:

1. Click the tab **Plants shared with me**, where you can view the plants that other users shared with you.
2. Choose the icons in the **Action** column for the following operations:
 - : Withdraw from the permission for the plant shared with you by another user.

7 Support

After logging in to the system, click **Support** in the side navigation bar. Here you can view the user manual and frequently asked questions, etc.

7.1 Warranty Query

After logging in to the iSolarCloud system, click **Support** in the side navigation bar. You will then go to “Warranty Query” .

No.	Device S/N	Device Type	Plant	Service Start Date	Service End Date	Warranty Period	Under Warranty
341	A1712301666	Inverter	Z18520619988的电站	28/Jul/2018	28/Jul/2028	121	Yes
342	A1712301426	Inverter	A19041200098的...	12/Apr/2018	12/Apr/2028	121	Yes
343	A1712119641	Inverter	shenmw的952第二...	14/Apr/2019	14/Apr/2024	60	Yes
344	A1711077927	Inverter	50KTL测试电站	10/Feb/2018	10/Feb/2023	60	No
345	A1711071868	Communication ...	A1711072270的...	12/Apr/2018	12/Apr/2023	60	No
346	A1710250056	Inverter	A17072601258的...	--	--	--	No
347	A1708044466	Communication ...	A1708044466的...	22/Dec/2017	22/Dec/2022	60	No
348	A1708044458	Communication ...	A1708044458的...	22/Dec/2017	22/Dec/2022	60	No
349	A1708044457	Communication ...	A1708044457的...	22/Dec/2017	22/Dec/2022	60	No
350	A1708043026	Inverter	A1910053872	--	--	--	No

Enter the **Plant name or device S/N**, set the **Start Time** and **End Time**, select the **Warranty Period**, and then click **Search** to check the warranty for the device.

7.2 Push Notifications

After logging in to the web system, choose **Support > Push Notifications** to go to the corresponding page.

7.2.1 Alarm Subscribe

"Alarm Subscribe" is used to manage the remote signaling status of devices in the plant, such as the fault, alarm, and suggestions.

Procedure

Alarm Subscribe Smart Alarm Analysis Setting Offline Notification

Plant or Plan Name Search +Add Batch Delete

<input type="checkbox"/>	No.	Plan Name	Plant Name	Creator	Creation Time	Action
<input type="checkbox"/>	1	to [plant icon]	Y1 [plant icon]	softtest	26/Oct/2023 20:49...	
<input type="checkbox"/>	2	to [plant icon]	[plant icon]	softtest	12/Oct/2023 20:40...	
<input type="checkbox"/>	3	wj-it	[plant icon]	softtest	21/Sep/2023 16:59...	
<input type="checkbox"/>	4	.	[plant icon]	softtest	08/Jul/2023 13:54:31	
<input type="checkbox"/>	5	[plant icon]	Y1 [plant icon]	softtest	07/Jun/2023 20:21...	
<input type="checkbox"/>	6	.	92 [plant icon]	softtest	12/Apr/2023 10:29:54	
<input type="checkbox"/>	7	2020 [plant icon]	[plant icon]	softtest	04/Jan/2023 22:07...	
<input type="checkbox"/>	8	.	[plant icon]	softtest	15/Dec/2022 10:38...	

- Search for a plan
 - Enter a **Plant or Plan Name**, and click **Search**. Plans that meet the search criteria will then be shown on the screen.
- Add a plan
 - Click **Add** in the upper right corner of the page.
 - Enter a plan name, select the plant, and select the faults of which you'd like to be reminded.
 - Click **Custom** to add an email that has not been used to create any iSolarCloud account. Complete information such as the email's language, the contact's name, and the frequency of notification. Enter the email address, and fill in the verification code that is sent to this address. Then, click **Confirm**.
 - Click **Select** to add an iSolarCloud user. Select the **Personal Name**, **Reminder Method**, and **Reminder Frequency**, and then click **Confirm**.
 - Click **Confirm** to save the current settings.
 - After the plan has been added, you can see its information on the **Alarm Subscribe** page.
- Delete a plan
 - Select the plan you want to delete in the plan list, and click .
 - A confirmation dialog will then pop up. Click **Confirm** to delete the plan.
- Delete plans in batch
 - Select the plans you want to delete in the plan list, and click **Batch Delete**.
 - A confirmation dialog will then pop up. Click **Confirm** to delete these plans.
- Modify a plan
 - Select the plan you want to edit in the plan list, and click .
 - On the **Modify** page, you can change the plan's name, select another plant, and select the information you want to receive in "Fault", "Alarm", and "Advice". You can also change the recipient of the reminder, and how this person will be reminded.

3. Click **Confirm** to change the plan settings.

7.2.2 Smart Alarm Analysis Setting

Procedure

- Search for an alarm
Select the plant and open status (open or shield), enter the alarm name, and click **Search**. The alarms that meet the search criteria will then be shown on the screen.
- Edit the suggestions

Alarm Name
Plant Stops Operation

Open Status
 Open Shield

Execution Frequency
60Minute(s)

Judgment Condition
7:00 - 19:00

Judgment Rule
Plant Stops Operation : Power/Installed Power of Plant < 1 %

1. Click  in the alarm list to go to "Intelligent Analysis Advice".
2. Here you can set the "Open Status", "Judgment Condition", and "Judgment Rule".
3. Click **Confirm** to apply the settings to one plant.
4. You can also click **Confirm and copy**, select one or more than one plant, and click **Confirm** to apply the settings to different plants.

7.2.3 Offline Notifications

Procedure

Alarm Subscribe Smart Alarm Analysis Setting Offline Notification

Plant Type Offline Time Notification Status Search Notifications

<input type="checkbox"/>	Plant Name	Plant Type	Owner's Email Address	Offline Time	Notification Status	Action
<input type="checkbox"/>	zjies...	Residential PV	22z4...	07/Dec/2023 17:01...	Notification Not Sent	

- Search for a notification
Select the plant type, offline time, and notification status, and click **Search**. The offline notifications that meet the search criteria will then be shown on the screen.
- Send notifications

1. In the list of offline notifications, click  to send an offline email notification to the Owner's email address.
2. Click **Confirm**.

7.3 Help Center

After logging in to the system, choose **Support > Help Center**.

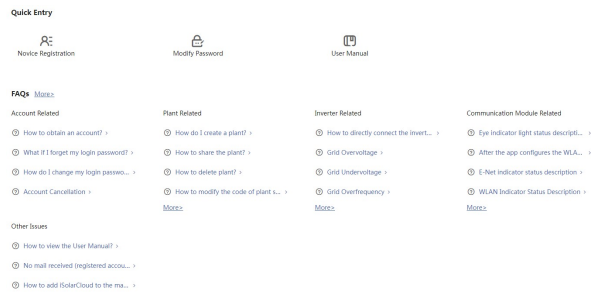

Here you can find the user manual and the answers to frequently asked questions.

8 Message Center

Click  in the upper right corner of the page. Here you can check the historical tasks related to plant creation, plant sharing, device update, and change of the installer.

Procedure

- Check messages
On the **Message Center** page, click **View** to check all messages in this group.
- Edit message status
Click **Edit** in the upper right corner of the page. You can delete messages, or set unread messages to “read”.

9 Account Management

Click the avatar in the upper right corner of the page to manage the settings and information related to the account.

9.1 Profile

Click the avatar and choose **Profile**.

You can click **Modify**, and edit information such as the nickname and user ID, country/region, and time zone.

9.2 Account and Security

Click the avatar and choose **Account and Security**.

You can associate your account with a phone number or email address, so that you can use it to reset your password if needed. You can also change your account password or delete your account.

9.3 Notifications

Click the avatar and choose **Notifications**.

Procedure

1. Turn on **Notifications** by selecting its checkbox.
2. Turn on **Smart Notification** by selecting its checkbox. You can set the frequency, content, and method of notification as you want.

Table 9-1 Smart Notification

Function	Description
Frequency of Notification	Once a day, once every 3 days, or once every 7 days.
Content	Abnormal Plant: Number of plants with faults or alarms. Offline for More Than 3 Days: Number of plants that have been put into power generation before yet stay offline for more than 3 days.
Method	Message Center

Function	Description
	App Email: If you add an email address here, the system will send a confirmation email to this address. After confirmation, you can receive reports through email.

9.4 General Settings

Click the avatar and choose **General Settings**.

- Set the default system language.
- Set the units of **Radiation** and **Temperature**.
- Turn on **Novice Guide** to allow for in-system guidance prompts.

9.5 Manufacturer Information

Click the avatar and choose **Manufacturer Information**. Here you can check the name, telephone number, email, and address of the manufacturer.

9.6 About

Click the avatar and choose **About**. Here you can check the current version of the system, Privacy Policy, and Declaration.

9.7 Back to Old Version

Click the avatar, and choose **Back to Old Version** to switch to the old version of the iSolarCloud system.

9.8 Logout

Click the avatar and choose **Logout**. You will then log out of the current account and go back to the login page.

10 Feedback

Click  at the bottom right of the page to open the feedback panel. You can fill in the form by referring to the table below.

Item	Description
Product Type (Required)	Hardware: Feedback on the device used in the plant. iSolarCloud: Feedback on the iSolarCloud O&M system. Others: Other feedbacks. iSolarDesign: Feedback on the plant design tool iSolarDesign.
Plant	Choose the plant about which you want to report a problem.
Device Type	Select a device that has been added in the plant.
Device S/N	Enter the S/N of the abnormal device.
Contact Information	Provide your phone number or email address, to get better assistance.
Problem Description (Required)	Describe your problem in at least 10 words, to get better assistance.
Screenshot	Click Screenshot to capture an image of the problem you want to report.
Upload	Upload a local image.

My Feedback

1. Click **My Feedback**. You will see the **All** tab by default. You can choose **Pending**, **Processing**, or **Closed** to check feedbacks in different states.
2. Click on a feedback to view its detailed information. You can click **Close Problem** if your problem has been resolved. If the problem has not been resolved, you may click **Reply** to provide more feedback on this problem.

SUNGROW

Sungrow Power Supply Co., Ltd.

www.sungrowpower.com