

User Manual

Optimizer

SP600S



All Rights Reserved

All Rights Reserved

No part of this document can be reproduced in any form or by any means without the prior written permission of Sungrow Power Supply Co., Ltd (hereinafter "SUNGROW").

Trademarks

SUNGROW and other SUNGROW trademarks used in this manual are owned by SUNGROW.

All other trademarks or registered trademarks mentioned in this manual are owned by their respective owners.

Software Licenses

- It is prohibited to use data contained in firmware or software developed by SUNGROW, in part or in full, for commercial purposes by any means.
- It is prohibited to perform reverse engineering, cracking, or any other operations that compromise the original program design of the software developed by SUNGROW.

About This Manual

The manual mainly contains the product information, as well as guidelines for installation, operation and maintenance. The manual does not include complete information about the photovoltaic (PV) system. Readers can get additional information at www.sungrowpower.com or on the webpage of the respective component manufacturer.

Validity

This manual applies to the following product:

- SP600S

It is referred to as "optimizer" hereinafter unless otherwise specified.

Target Group

This manual is intended for professional technicians who are responsible for installing, operating, and maintaining the optimizer and users who need to check optimizer parameters.

The optimizer must and can only be installed by professional technicians. The professional technician is required to meet the following requirements:

- Know electronic, electrical wiring, and mechanical expertise, and be familiar with electrical and mechanical schematics.
- Have received professional training related to the installation and commissioning of electrical equipment.
- Be able to quickly respond to hazards or emergencies that occur during installation and commissioning.
- Be familiar with local standards and relevant safety regulations of electrical systems.
- Read this manual thoroughly and understand the safety instructions related to operations.

How to Use This Manual

Please read this manual carefully before using the product and keep it properly at a place for easy access.

Contents of the manual may be updated and amended continuously, so it is possible that there may be some errors or slight inconsistency with the actual product. Please refer to the actual product purchased, and the latest manual can be obtained from support.sungrowpower.com or sales channels.

Security Declaration

To learn more about the the product network security vulnerability disclosure and handling process, you can visit <https://en.sungrowpower.com/security-vulnerability-management> For more details on network security, see the user manual for the matching communication module/data logger of the product.

Symbol Explanations

To ensure the safety of the users and their properties when they use the product and to make sure that the product is used in an optimal and efficient manner, this manual provides users with the relevant safety information highlighted by the following symbols.

Below is a list of symbols that are used in this manual. Review them carefully to make better use of this manual.

DANGER

Indicates an imminently hazardous situation which, if not avoided, will result in death or serious injury.

WARNING

Indicates a moderately hazardous situation which, if not avoided, will result in death or serious injury.

CAUTION

Indicates a slightly hazardous situation which, if not avoided, may result in minor or moderate injury.

NOTICE

Indicates a potential hazard which, if not avoided, will result in device malfunction or property damage.



Indicates additional information, emphasized contents, or tips that may be helpful, e.g. to help you solve problems or save time.

Contents

All Rights Reserved.....	I
About This Manual.....	II
1 Safety Instructions.....	1
1.1 Unpacking and Inspection.....	1
1.2 Installation Safety.....	1
1.3 Electrical Connection Safety.....	2
1.4 Operation Safety.....	3
1.5 Maintenance Safety.....	3
1.6 Disposal Safety.....	4
2 Product Description.....	5
2.1 System Introduction.....	5
2.2 Working Principle.....	6
2.3 Product Introduction.....	6
2.4 Symbol Descriptions.....	9
2.5 Configuration Principles.....	9
2.6 Application Scenarios.....	11
3 Unpacking and Storage.....	13
3.1 Unpacking and Inspection.....	13
3.2 Storage.....	13
4 Mechanical Mounting.....	15
4.1 Installation Location Selection.....	15
4.2 Installation Tools.....	15
4.3 Installing Optimizer.....	16
4.3.1 Preparation Before Installation.....	16
4.3.2 Installed on PV Module (Clip).....	17
4.3.3 Installed on Aluminum Guide Rail.....	18
4.3.4 Installed on Steel Guide Rail (T-head Bolt).....	19
4.3.5 Installed on Steel Guide Rail (Bolt Assembly).....	19
5 Electrical Connection.....	21
5.1 Safety Precautions.....	21
5.2 Terminal Description.....	22
5.3 Terminal Preparation.....	23
5.4 Connecting to PV Module.....	24
5.5 Module Layout and Optimizer Connection.....	28

6 Commissioning	33
6.1 Inspection Before Commissioning.....	33
6.2 Set Optimizer Physical & Logical Layouts.....	33
6.2.1 Method 1: Set layout by importing Excel template.....	33
6.2.2 Method 2: Set layout manually.....	34
6.3 PLC Communication Setup.....	37
6.4 Viewing Optimizer Layout.....	38
7 Optimizer Decommissioning	44
7.1 Disconnecting Optimizer.....	44
7.2 Dismantling Optimizer.....	44
7.3 Disposal of Optimizer.....	45
8 Troubleshooting and Maintenance	46
8.1 Troubleshooting.....	46
8.2 Maintenance.....	47
8.2.1 Maintenance Notices.....	47
8.2.2 Routine Maintenance.....	47
8.2.3 Rapid Shutdown.....	48
8.2.4 Replacing Optimizer.....	48
9 Appendix	51
9.1 Technical Data.....	51
9.2 Quality Assurance.....	52
9.3 Contact Information.....	53

1 Safety Instructions

When installing, commissioning, operating, and maintaining the device, strictly observe relevant safety instructions. Incorrect operation or work may cause:

- Injury or death to the operator or a third party.
- Damage to the device and other properties.

Strictly follow the safety instructions stated in the manual to avoid the hazards mentioned above.



- The safety instructions in this manual are only supplements and cannot cover all the precautions that should be followed. Perform operations considering actual on-site conditions.
- SUNGROW shall not be held liable for any damage caused by violation of general safety operation requirements, general safety standards, or any safety instruction in this manual.
- When installing, operating, and maintaining the device, comply with local laws and regulations. The safety precautions in this manual are only supplements to local laws and regulations.

1.1 Unpacking and Inspection

WARNING

Check all safety signs, warning labels, and nameplates on products. The safety signs, warning labels and nameplates must be clearly visible and cannot be removed or covered before the product is decommissioned.

NOTICE

After receiving the product, check whether the appearance and structural parts of the device are damaged, and check whether the product received is consistent with the order. If there are problems with the above inspection items, do not install the device and contact SUNGROW in time.

1.2 Installation Safety

DANGER

Make sure there is no electrical connection before installation.

NOTICE

Before operating the product, please check and ensure that tools to be used have been maintained regularly.

1.3 Electrical Connection Safety

⚠ DANGER

Before electrical connections, please make sure that the optimizer is not damaged. Otherwise, it may cause danger!

Before electrical connections, please make sure that all switches connected to the optimizer are set to "OFF". Otherwise, electric shock may occur!

The optimizer does not support hot plugging. Do not plug in and out the optimizer with power on. Otherwise, the optimizer may be damaged!

⚠ DANGER

The PV string will generate lethal high voltage when exposed to sunlight.

- Operators must wear proper personal protective equipment during electrical connections.
- Must ensure that cables are voltage-free with a measuring instrument before touching DC cables.
- Respect all safety instructions listed in relevant documents about PV strings.

⚠ DANGER

- Be sure to use special insulation tools during cable connections.
- Note and observe the warning labels on the optimizer, and perform operations strictly following the safety instructions.
- Respect all safety precautions listed in this manual and other pertinent documents.

⚠ WARNING

Damage to the product caused by incorrect wiring is not covered by the warranty.

- Electrical connection must be performed by professionals.
- All cables used in the PV generation system must be firmly attached, properly insulated, and adequately dimensioned.

⚠ WARNING

Check the positive and negative polarity of the PV strings, and connect the PV connectors to corresponding terminals only after ensuring polarity correctness. During the installation and operation of the optimizer, please ensure that the positive or negative polarities of PV strings do not short-circuit to the ground. Otherwise, the product may be damaged. And the damage caused by this is not covered by the warranty.

NOTICE

Comply with the safety instructions related to PV strings and the regulations related to the local grid.

1.4 Operation Safety

⚠ DANGER

- When the product is running, it is strictly forbidden to plug and unplug any connector on the optimizer.
- When the product is running, do not disassemble any parts of the optimizer. Otherwise, electric shock may occur.
- Do not touch the product when it is running. Otherwise, it may cause burns.

NOTICE

Do not take other actions, such as setting parameters, during the process of inverter firmware update, to avoid update failure.

1.5 Maintenance Safety

⚠ DANGER

Risk of device damage or personal injury due to incorrect service!

- Be sure to use special insulation tools when perform high-voltage operations
- Before maintaining the optimizer, first cut off the power input and the power output, and measure the voltage and current with professional measuring instrument. Only when there is no voltage nor current can operators who wear protective equipment operate and maintain the optimizer.
- Even if the product is shut down, it may still be hot and cause burns. Operating the product with protective gloves after it cools down.

⚠ WARNING

If a fault occurs during operation, be sure to re-power the optimizer after the fault is cleared. Otherwise, the fault may expand, or the device may be damaged.

⚠ CAUTION

To prevent misuse or accidents caused by unrelated personnel, post prominent warning signs or demarcate safety warning areas around the product to prevent accidents caused by misuse.

NOTICE

To avoid the risk of electric shock, do not perform any other maintenance operations beyond this manual. If necessary, contact SUNGROW for maintenance. Otherwise, the losses caused are not covered by the warranty.

1.6 Disposal Safety

⚠ WARNING

Please scrap the product in accordance with relevant local regulations and standards to avoid property losses or casualties.

2 Product Description

2.1 System Introduction

SP600S optimizer is mainly used to adjust the voltage and current of each PV module in real time to track the maximum power point of each module, thus improving the power generation capacity of the PV system. It can also realize module-level shutdown, module-level IV curve scanning and automatic physical recognition.

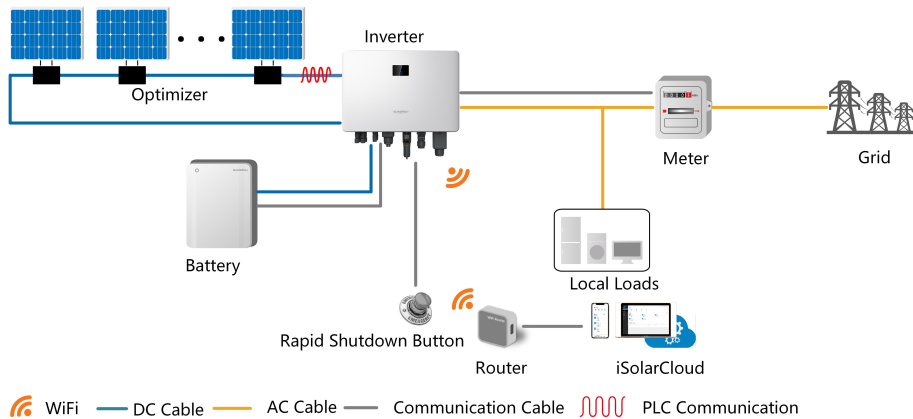

Figure 2-1 Application to Residential PV and Storage System

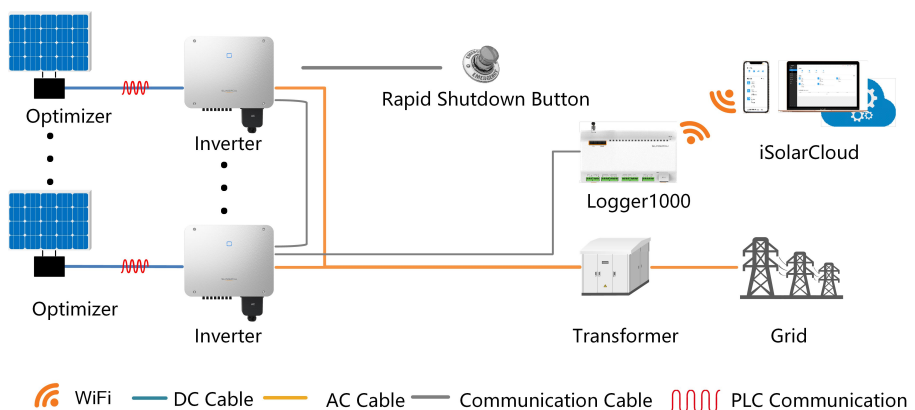

Figure 2-2 Application to Industrial and Commercial System

NOTICE

SP600S optimizer is not compatible with third-party products.

2.2 Working Principle

The working principle of the optimizer is shown in the diagram below. Connected to the PV module by its input cable, the optimizer can track the module's maximum power and output the desired voltage through a DC/DC voltage conversion circuit.

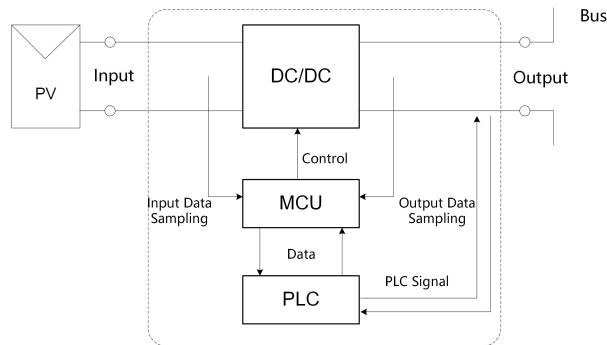

Figure 2-3 Working Principle

2.3 Product Introduction

Model Description

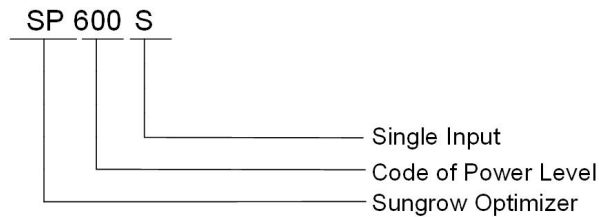

Figure 2-4 Model Description

Product Appearance

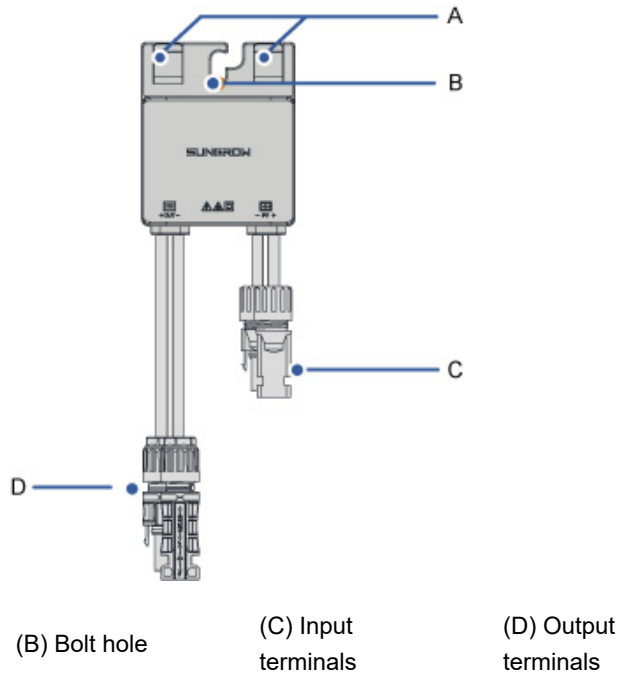

Figure 2-5 Product Appearance

* The image shown here is for reference only. The actual product received may differ.

Dimensions

There are two kinds of input cables of the optimizer.

1. Short PV wire version:

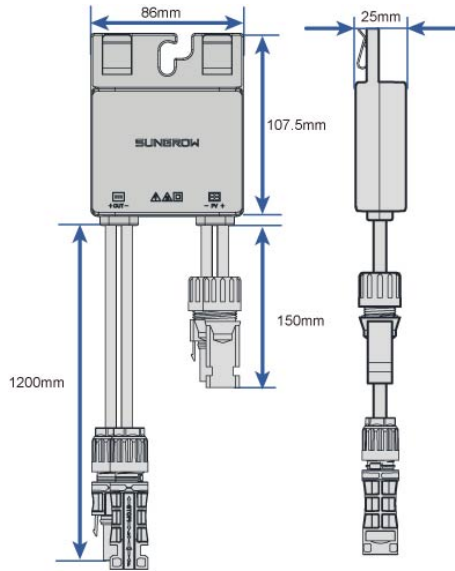

Figure 2-6 Optimizer (short PV wire version)

2. Long PV wire version:

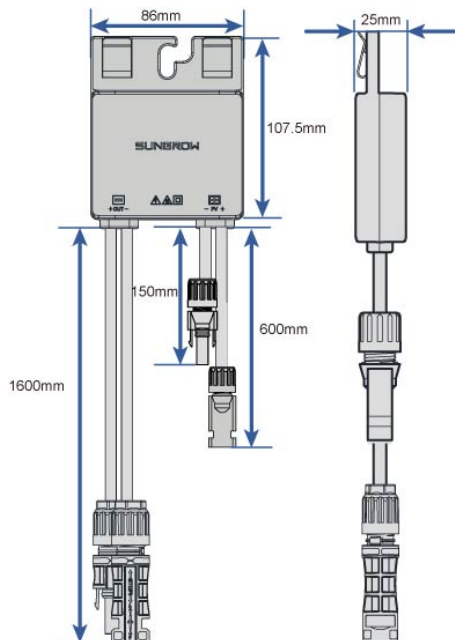









Figure 2-7 Optimizer (long PV wire version)

2.4 Symbol Descriptions

Symbol	Description
	Do not dispose of the optimizer as household waste.
	Read the manual before performing any operation on the optimizer.
	Comply with CE certification. EU/EEA importer.
	Comply with RCM certification.
	RoHS labeling The product complies with the requirements of the applicable EU directives.
	Hot surface with a temperature that may exceed 60 °C. Risk of burns!
	Risk of electric shock!
	Equipment protected by double insulation or reinforced insulation.

2.5 Configuration Principles

Limit on the Number of Optimizers for a Single Inverter

The inverter models supported by the optimizer are shown in the following table. The number of optimizers supported in a PV string and the upper limit of the string power vary according to the inverter model. The configuration principles for different inverter models are as follows:

Supported Inverter Models	Number of Optimizers Supported in a String	Upper Limit of String Output Power
SG2.0/2.5/3.0RS-S	4–25	7.68 kW

Supported Inverter Models	Number of Optimizers Supported in a String	Upper Limit of String Output Power
SG3.0/3.6/4.0/5.0/6.0/8.0/9.0/10RS		
SG3.0/4.0/5.0/6.0/7.0/8.0/10/12/15/17/20RT-P2	6–35	12.5 kW
SG25/30/33/36/40/50CX-P2	6–35	13.6 kW
SH3.0/3.6/4.0/5.0/6.0RS	4–25	6.6 kW
SG125CX-P2	6–35	13.6 kW

Maximum Number of Optimizers Supported by Different Communication Devices



The SP600S optimizer must be used with the compatible SUNGROW communication devices.

Communication Device	Maximum Number of Optimizers Supported by a Single Device
Winet-S2	400
EyeS4-EU	400
Logger1000A/B	4900
Logger1000A-EU	4900



Connecting an optimizer to the system does not affect the configuration of the communication device and inverter. For specific requirements, refer to the user manual for the corresponding communication device.

Compatibility of Inverters with Communication Modules

Inverter Models	System
SGRS series	SP600S + Winet-S2 + iSolarCloud
SGRT-P2 series	SP600S + Winet-S2 + iSolarCloud
SHRS series	SP600S + Winet-S2 + iSolarCloud
SGCX-P2	SP600S + Winet-S2 + iSolarCloud
	SP600S + Logger1000/COM100 + iSolarCloud

Inverter Models	System
SGCX-P2 & SGRT-P2	SP600S + Logger1000 + iSolarCloud

NOTICE

When connecting multiple SGRT-P2 inverters, or when combining SGRT-P2 inverters with other inverter models, the maximum number of SGRT-P2 inverters allowed is 5.

NOTICE

- Two PV strings connected in parallel to the same MPPT must have the same number of modules, otherwise, the optimizers may not function properly.
- If more than one optimizer in the parallel strings is damaged during system operation, the inverter will trigger an alarm. In such cases, perform troubleshooting in time according to the alarm message and replace the optimizers.
- Please arrange the layout of the plant properly according to the requirements of local laws and regulations. If the number of optimizers in a string exceeds 30, it fails to meet the 30V rapid shutdown requirements.

2.6 Application Scenarios

Full Deployment Scenario

Full deployment scenario: All PV modules connected to the inverter are equipped with optimizers.

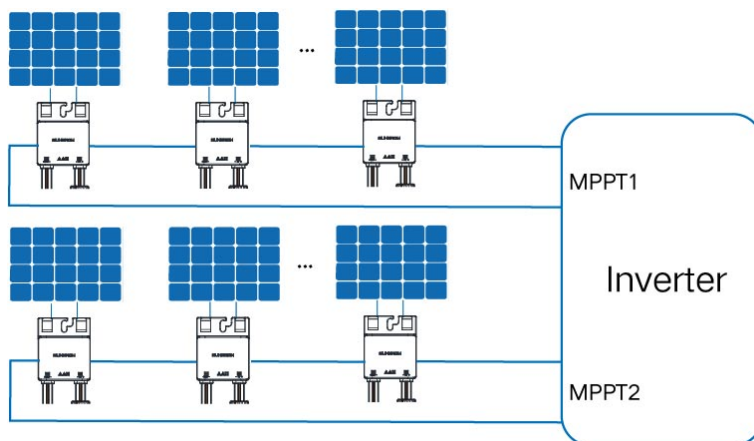

Figure 2-8 Optimizers Installed for All PV Modules

Partial MPPT Deployment Scenario

Partial MPPT deployment scenario: Only PV modules connected to some of the MPPTs are fully equipped with optimizers.

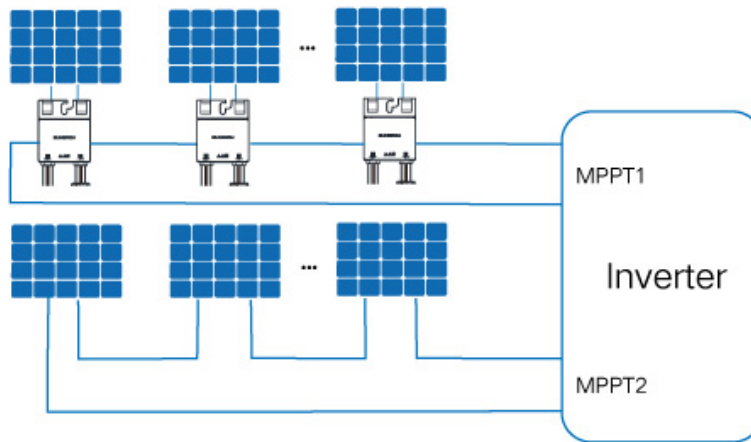

Figure 2-9 Optimizers Installed for Shaded PV Modules

NOTICE

- Partial MPPT deployment is available only for the following models: SG5.0/6.0/8.0/10/12/15/17/20RT-P2, SG2.0/2.5/3.0RS-S, SG3.0/3.6/4.0/5.0/6.0/8.0/9.0/10RS, SH3.0/3.6/4.0/5.0/6.0RS.
- Rapid shutdown is not supported in partial MPPT deployment scenario.
- Long strings are not supported in partial MPPT deployment scenario.
- Smart IV curve diagnosis is not supported in partial MPPT deployment scenario.
- Optimizer auto search is not supported in partial MPPT deployment scenario.

3 Unpacking and Storage

3.1 Unpacking and Inspection

The device is thoroughly tested and strictly inspected before delivery. Nonetheless, damage may still occur during shipping. For this reason, please conduct a thorough inspection after receiving the device.

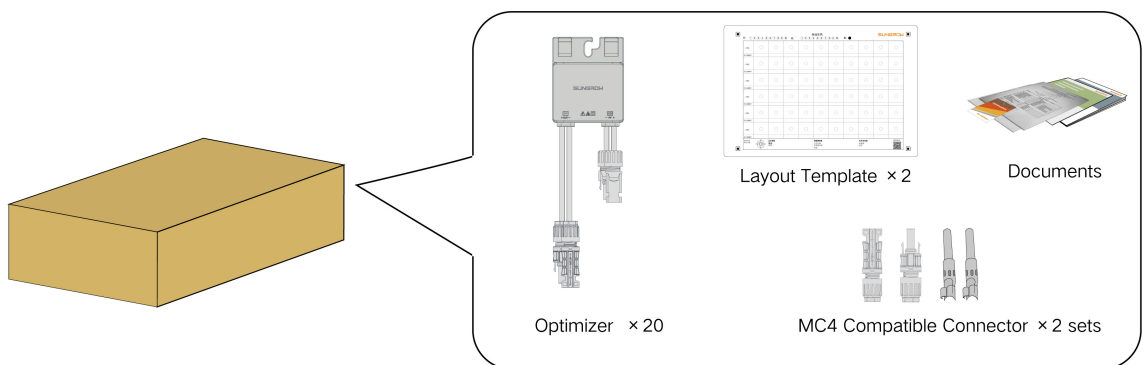

- Check the packing case for any visible damage.
- Check the inner contents for damage after unpacking.

Contact SUNGROW or the transport company in case of any damage or incompleteness, and provide photos to facilitate services.

Do not dispose of the original packing case. It is recommended to store the device in the original packing case when the product is decommissioned.

NOTICE

After receiving the product, check whether the appearance and structural parts of the device are damaged, and check whether the packing list is consistent with the actual order. If there are problems with the above inspection items, do not install the device and contact SUNGROW in time.
If any tool is used for unpacking, be careful not to damage the product.

3.2 Storage

If the optimizer is not put into operation immediately, store it under specific environmental conditions.

- Repack it with original packing case.

- The storage temperature ranges from -40 °C to 85 °C, and the relative humidity ranges from 0 to 95%, without condensation.
- Stacking layers of optimizer shall not exceed the "stacking layer limit" marked on the outer case.
- The carton box cannot be tilted or turned upside down.
- Do not store the product in places susceptible to direct sunlight, rain, and strong electric field.
- Do not place the product in places with items that may affect or damage the product.
- Store the product in a clean and dry place with fine ventilation to prevent dust and water vapor from eroding.
- Do not store the product in places with corrosive substances or susceptible to rodents and insects.
- Carry out periodic inspections. Inspection shall be conducted at least once every six months. If any insect or rodent bites are found, replace the packaging materials in time.
- If the product has been stored for more than a year, inspection and testing by professionals are required before it can be put into operation.

NOTICE

Please store the product according to the storage requirements. Product damage caused by failure to meet the storage requirements is not covered by the warranty.

4 Mechanical Mounting

WARNING

Respect all local standards and requirements during mechanical installation.

4.1 Installation Location Selection

Select an optimum installation location for an optimizer to operate safely, ensuring its service life and performance.

- The optimizer is rated IP68.
- It should be installed at a position convenient for electrical connection, operation and maintenance.

Installation Environment Requirements

- The installation environment must be free of flammable or explosive materials.
- Install the optimizer in a place with shelter, so as to prevent it from getting impacted by direct sunlight and severe weather (e.g. snow, rain, and lightning). The optimizer will derate in high temperatures for self-protection. If installed in a place directly exposed to sunlight, as the temperature rises, the optimizer may witness power reduction.
- The product must be out of reach of children.
- The allowable temperature and humidity range at the installation site are as follows:

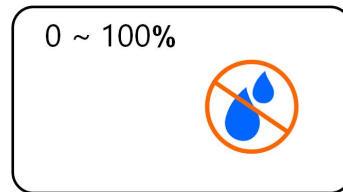
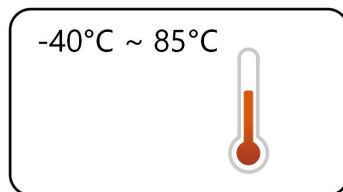

- The product should be protected from direct sunlight, rain and snow to prolong its service life. A sheltered installation location is recommended.
- Install the device in a well-ventilated place to ensure good heat dissipation.

4.2 Installation Tools

Installation tools include but are not limited to the following recommended ones. Use other auxiliary tools on site as needed.



Protective gloves



Insulated shoes

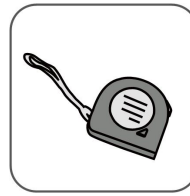

Tape

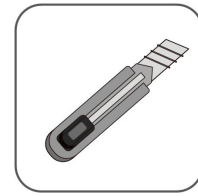

Utility knife



Wire cutter

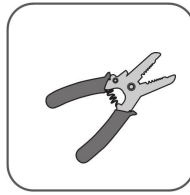

Wire strippers

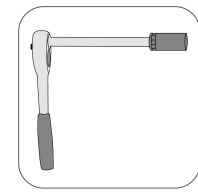
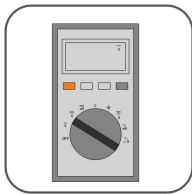

Crimping tool

Socket wrench
(M8)

Multimeter

Open-end wrench
kit

4.3 Installing Optimizer

Prerequisite

The optimizer supports both clip installation and bolt installation. Please choose the appropriate installation method according to the site conditions.

4.3.1 Preparation Before Installation



Arrange the installation position of an optimizer reasonably to ensure that optimizer cables can be normally connected to the PV module and an adjacent optimizer. The communication distance between the optimizer and the inverter should be no more than 350m.

Select the appropriate installation position of the optimizer, remove the QR code label on the optimizer, and paste it onto the **layout template** as instruction on the backside of layout paper.

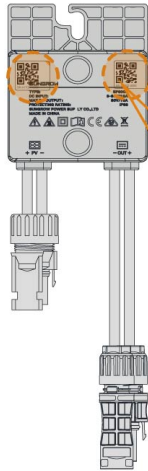
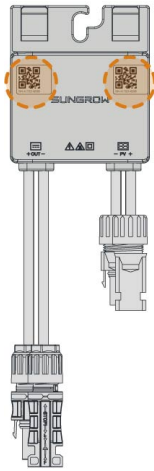

1. Please read through the instructions on the back of the layout template before the operation.

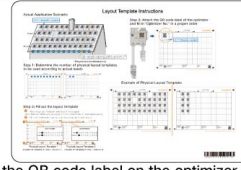

2. Remove the QR code label on the optimizer, and paste it onto the layout template.



- Affix the QR code label to the template according to the actual location of the optimizer on site.
- Keep the QR code label flat and even, and make sure it does not go outside the cell border.

4.3.2 Installed on PV Module (Clip)

Step 1 As shown in the figure below, clamp the optimizer parallel to the back of the PV module by clips.

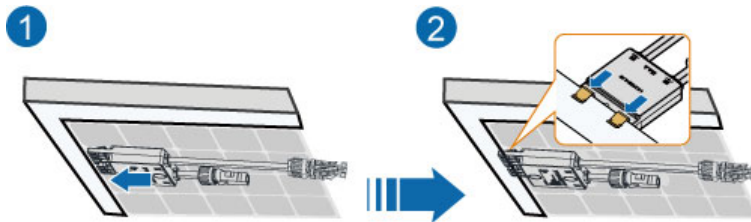

NOTICE

- Please ensure that the optimizer is installed facing the back of the module. Otherwise, the clip may get damaged.

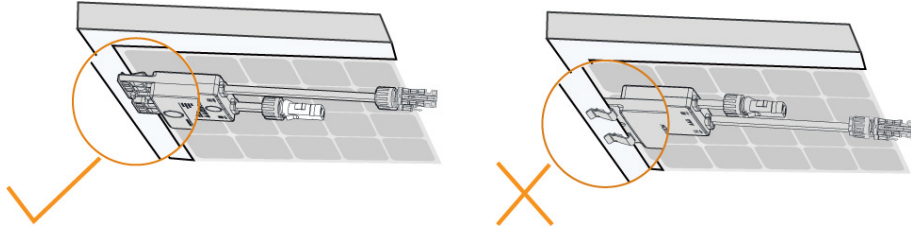

- Do not forcibly bend the clips when installing the optimizer by clips. Otherwise, the clip may be damaged.

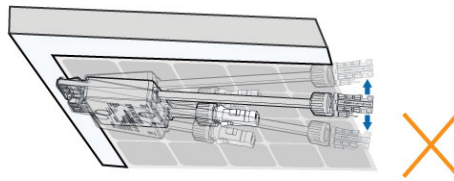

- Do not clamp the optimizer into holes in the module frame during installation. Otherwise, the optimizer cannot be removed or the clips may be damaged.

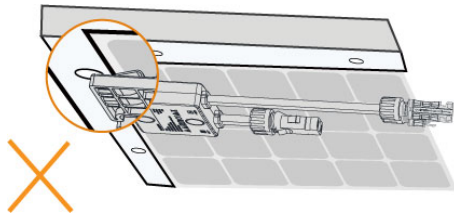

- It is recommended to install optimizers on the same side of modules.
- Do not clamp and remove the optimizer multiple times. Otherwise, the clip may become loose, affecting normal use.

--End

4.3.3 Installed on Aluminum Guide Rail

Step 1 It is recommended to use M8*25 T-head bolt assembly (not included in the scope of delivery). Slide the T-head bolt into the groove in the aluminum guide rail.

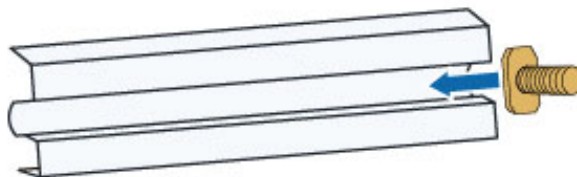

Step 2 Hang the optimizer onto the T-bolt through the bolt hole, and secure it to the aluminum guide rail using a socket wrench in the order of nut, bolt hole and T-head bolt.

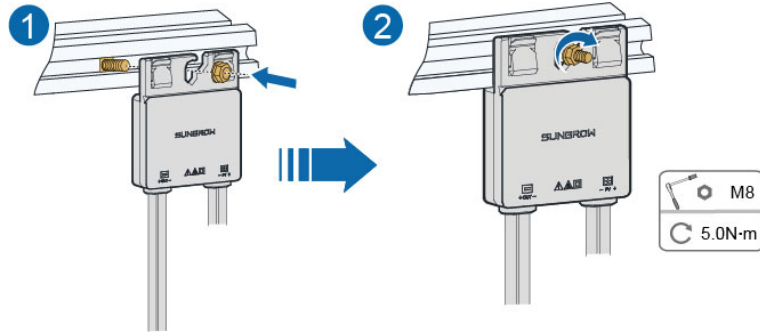

--End

4.3.4 Installed on Steel Guide Rail (T-head Bolt)

Step 1 It is recommended to use M8*25 T-head bolt assembly (not included in the scope of delivery). Insert the T-head bolt through the guide rail and turn it 90°.



Step 2 Hang the optimizer onto the T-head bolt through the bolt hole, and secure it to the steel guide rail using a socket wrench in the order of nut, bolt hole and T-head bolt.

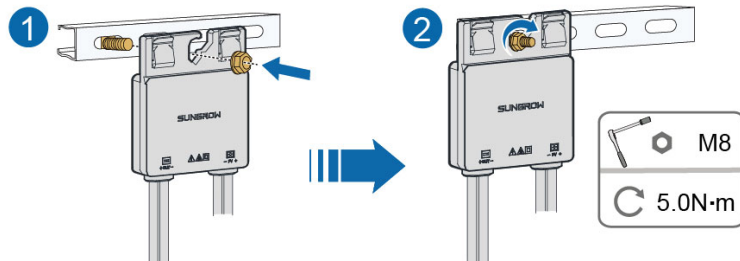

--End

4.3.5 Installed on Steel Guide Rail (Bolt Assembly)

Step 1 It is recommended to use M8*25 bolt assembly (not included in the scope of delivery). Put the bolt assembly on the guide rail.



Step 2 Hang the optimizer onto the bolt through the bolt hole, and secure it to the steel guide rail using a socket wrench in the order of nut, bolt hole, spring washer, flat washer and bolt.

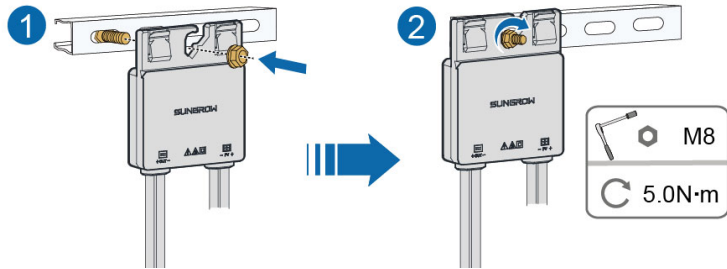

Please install the optimizer with its back tightly against the bracket. Installing it from the opposite direction may damage the optimizer, and such damage will not be covered by warranty.

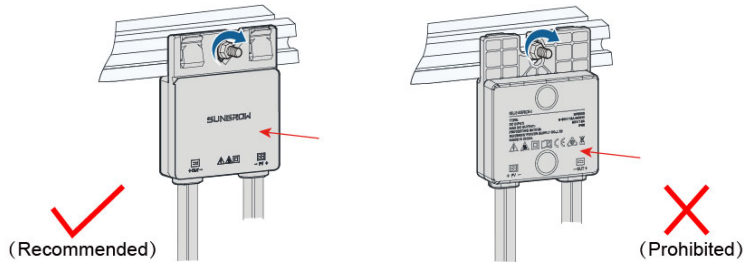

--End

5 Electrical Connection

5.1 Safety Precautions

DANGER

The PV string will generate lethal high voltage when exposed to sunlight.

- Operators must wear proper personal protective equipment during electrical connections.
- Must ensure that cables are voltage-free with a measuring instrument before touching DC cables.
- Respect all safety instructions listed in relevant documents about PV strings.

DANGER

Before electrical connections, please make sure that the optimizer is not damaged. Otherwise, it may cause danger!

Before electrical connections, please make sure that all switches connected to the optimizer are set to "OFF". Otherwise, electric shock may occur!

The optimizer does not support hot plugging. Do not plug in and out the optimizer with power on. Otherwise, the optimizer may be damaged!

Please check whether the input and output cables of each optimizer are connected incorrectly, i.e. whether the output is connected to the PV module and the input is connected to the inverter or to other optimizers in the system. If so, please correct the connection in time and confirm that the connection is correct before creating a plant and activating it. Otherwise, it may result in damage to the optimizer that is wrongly connected after the plant is activated, and the damage caused will not be covered by the warranty.

WARNING

Damage to the product caused by incorrect wiring is not covered by the warranty.

- Electrical connection must be performed by professionals.
- Operators must wear proper personal protective equipment during electrical connections.
- All cables used in the PV generation system must be firmly attached, properly insulated, and adequately dimensioned.

CAUTION

Please refer to terminal configuration description from inverter user manual if the inverter strings are not fully connected. Otherwise, it may cause power loss.

NOTICE

All electrical connections must comply with local and national/regional electrical standards.

- Cables used by the user shall comply with the requirements of local laws and regulations.

NOTICE

Comply with the safety instructions related to PV strings and the regulations related to the local grid.



The cable colors in the figures in this manual are for reference only. Please select cables according to local cable standards.

5.2 Terminal Description

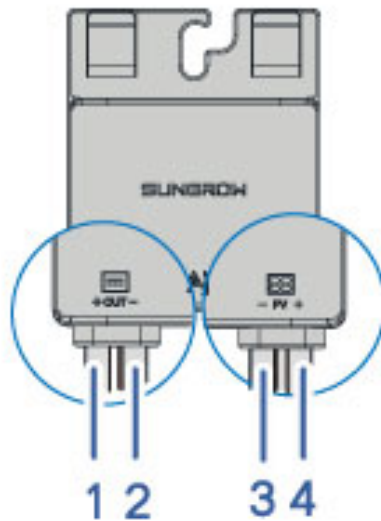

Figure 5-1 Internal Terminal

No.	Silk screen	Description
1	OUT+	Positive output
2	OUT-	Negative output
3	PV-	Negative Input
4	PV+	Positive input

5.3 Terminal Preparation

In the process of connecting optimizers, if the distance between terminals is too long, it is necessary to prepare a pair of extension cables.

NOTICE

Please make sure the DC connector is the same or compatible with the product connector. Otherwise, the damage caused will not be covered by the warranty.

Step 1 Strip the insulation layer of all DC cables to a length L of about 7 mm - 8 mm.

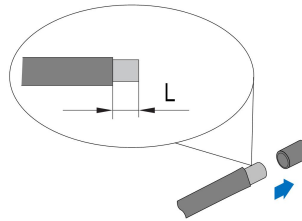

Step 2 Assemble the cable ends with the wiring terminal by the crimping tool.

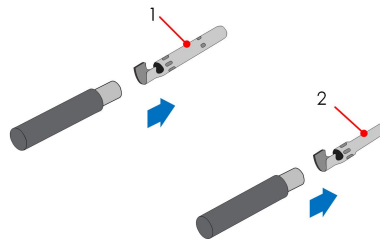

(1): Positive crimp contact

(2): Negative crimp contact

NOTICE

When making the adapter cable, please make sure the model of the OT terminal is the same as that of the DC connector. Otherwise, it may lead to unreliable connection and DC connector burnout.

Step 3 Lead the cable through cable gland, and insert the crimp contact into the insulator until it snaps into place. Gently pull the cable backward to ensure firm connection. Tighten the cable gland and the insulator with a torque of 2.5 N.m - 3 N.m.

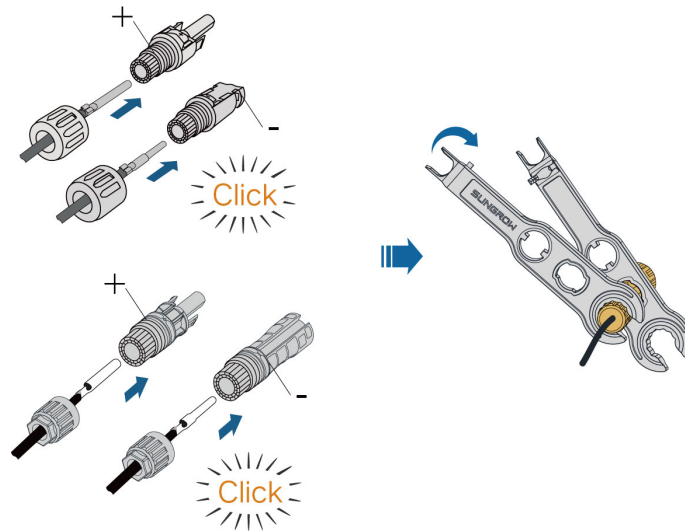

Step 4 Connect the positive terminals of the PV connector to corresponding negative terminals until there is an audible click.

--End

5.4 Connecting to PV Module

Prerequisite

⚠ DANGER

Electric shock!
Pay attention! PV arrays will generate lethal high voltage when exposed to sunlight.
Ensure all cables are voltage-free before performing electrical operations.

⚠ WARNING

- **Make sure the PV array is well insulated to the ground before connecting an optimizer to a PV module.**



Shorten the distance between the positive and negative cables of the optimizer according to on-site conditions to reduce electromagnetic interference.

Step 1 Connect the PV+ and PV- of the optimizer to the positive and negative terminals in the junction box of the PV module respectively.

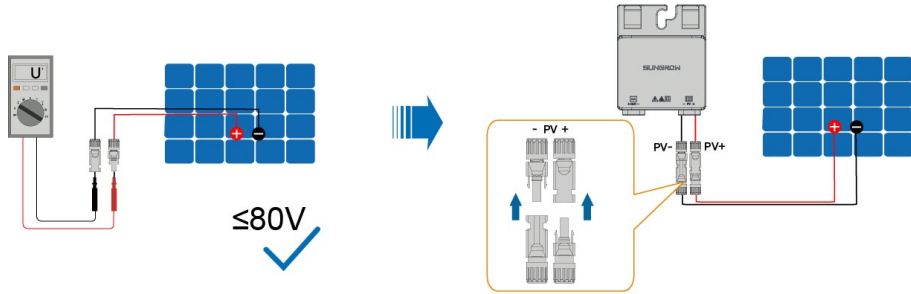

⚠ WARNING

- Before installing the optimizer, confirm the specifications of the PV module, and use a multimeter to test the voltage at the terminals of the PV cables to be connected to the optimizer's input terminals. Connect the optimizer only after confirming that the voltage is below 80V, otherwise, the optimizer may be damaged.
- Do not connect the PV module to the OUT+ and OUT- of the optimizer. Otherwise, the optimizer or PV module will be damaged, and the loss is not covered by the warranty.

Step 2 Connect the positive probe of a multimeter to OUT+ of the optimizer, and the negative probe of the multimeter to OUT— of the optimizer to check whether the optimizer is faulty. If typical value of output voltage is 1V, no fault occurs to the optimizer.

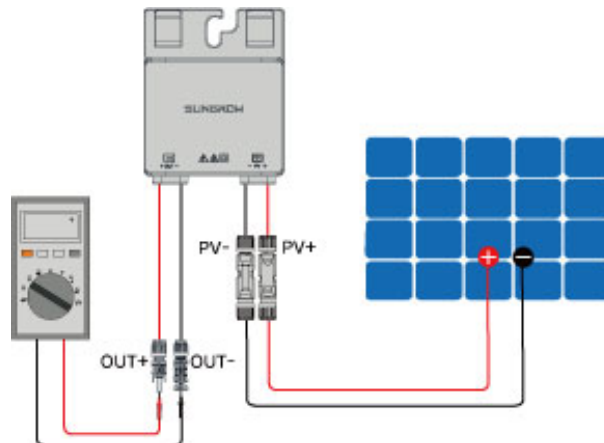

NOTICE

1. Use a multimeter to measure the output voltage of each optimizer after wiring.
2. Considering the effect of the accuracy of the multimeter on the actual measurement on site, the optimizer can function normally as long as the output voltage falls in the range of 0.9V - 1.1V.
3. If the output voltage is less than 0.9 V, check the following items:
 - Check whether the sunlight is sufficient.
 - Check whether the input side of the optimizer is connected to the PV module.
 - If the fault is not caused by foregoing reasons and still persists, please replace the optimizer.
4. If the output voltage is greater than 1.1 V, the optimizer fails. Please replace the optimizer.
5. If no voltage is detected, replace the optimizer or component.

⚠ WARNING

If you do not check the optimizer output voltages and confirm the string has been wired properly in this step, in case of something abnormal, you may have to check the whole wiring again, where rework is required.

Step 3 When connecting multiple optimizers, connect OUT- of the first optimizer to OUT + of the second optimizer, and so on. Use a multimeter to measure the optimizer voltage. If typical value of output voltage is $1V \times N$ (N is the number of optimizers), no fault occurs to the system.

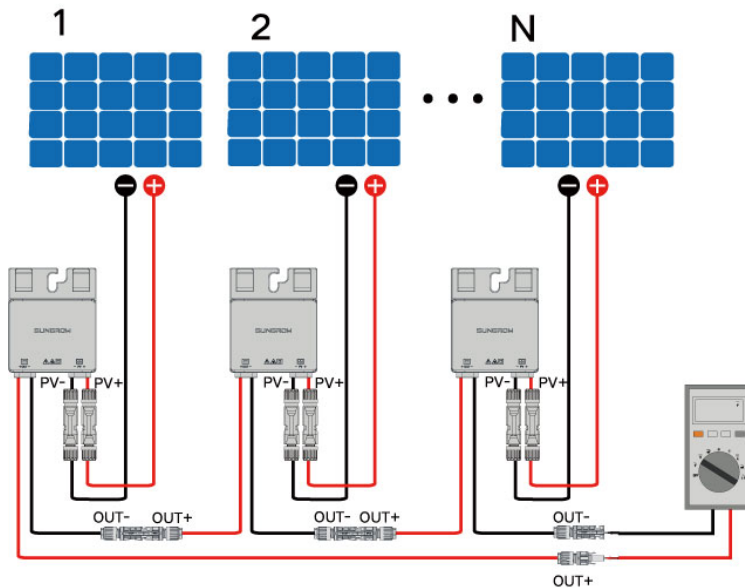

NOTICE

Whether connecting OUT+ of the first optimizer to OUT- of the second optimizer or connecting OUT- of the first optimizer to OUT+ of the second optimizer is dependent on the polarity of the extension cable that is connected to the inverter on site.

⚠ WARNING

After wiring, be sure to check and confirm that the string output voltage is in normal range. Otherwise, it may lead to optimizer damages and wiring rework.

Step 4 Connect OUT+ of the first optimizer and OUT- of the last optimizer to the PV input terminals of the inverter.

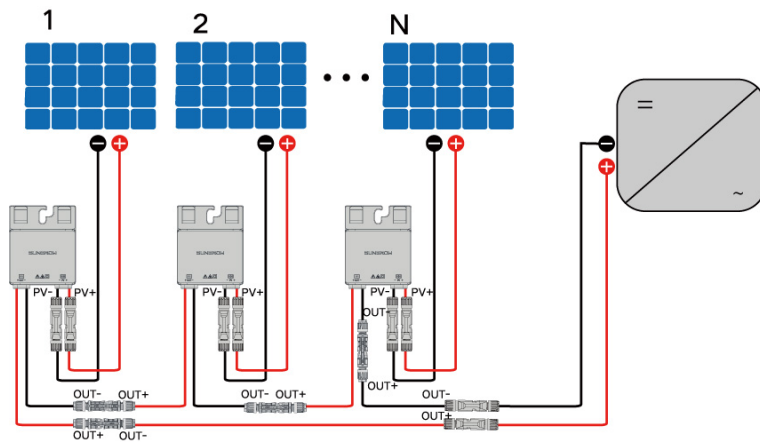

⚠ WARNING

If each PV module is equipped with an optimizer, the total power of PV modules in a PV input shall not exceed the maximum input power of a single PV input of the inverter.

⚠ CAUTION

Please refer to terminal configuration description from inverter user manual if the inverter strings are not fully connected. Otherwise, it may cause power loss.

NOTICE

- **Branch-connector connection on the input side of the inverter is not supported by the optimizer.**
- **Do not coil the optimizer's extension cable when wiring, given that the communication quality may decline if the extension cable is too long.**

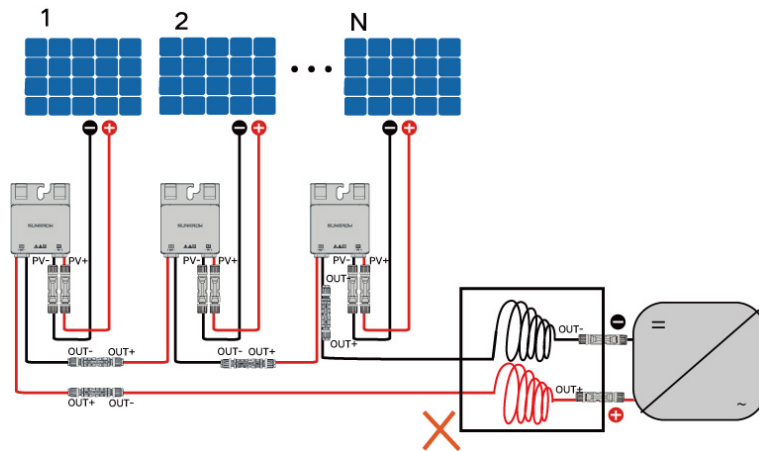

--End

5.5 Module Layout and Optimizer Connection

The PV modules can be installed vertically or horizontally.



It is recommended that the optimizer be installed by the clip. Install all optimizers on the same side of PV module frames near the junction box.

Optimizer Connection (Vertical PV Modules)

If PV modules are installed vertically, connect optimizers as shown in the figure below.

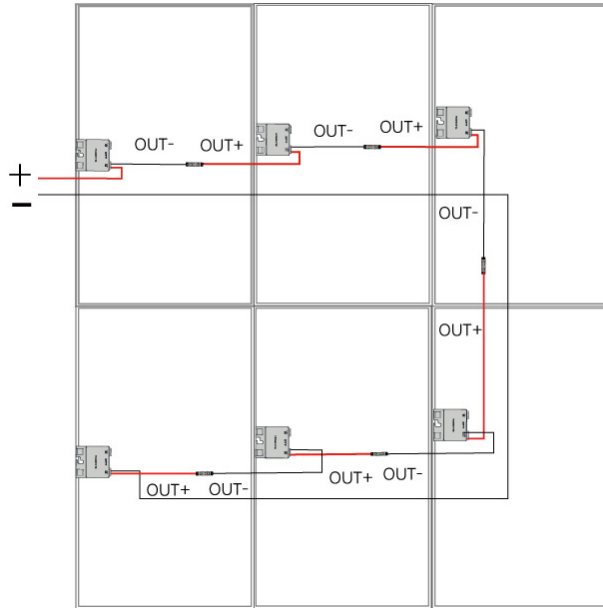

Optimizer Connection (Horizontal PV Modules)

If the peak power of the PV module is between 400 ~ 500 Wp:

Connect optimizers as shown in the figure below.

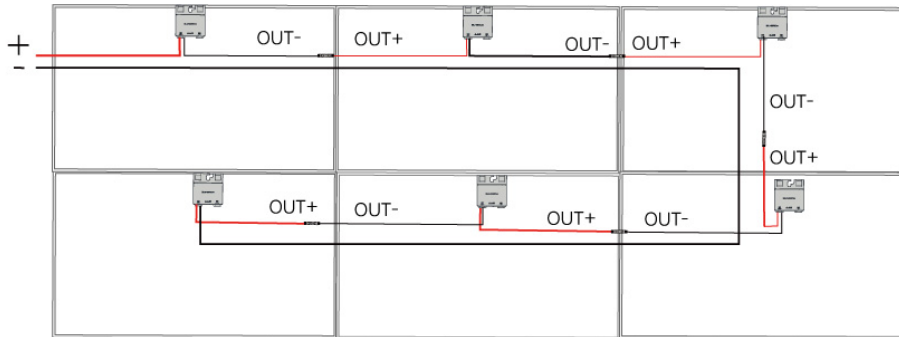

If the peak power of the PV modules is between 500 ~ 600 Wp, the module is big, and it is recommended that the optimizer be connected in S shape.

Connect optimizers as shown in the figure below.

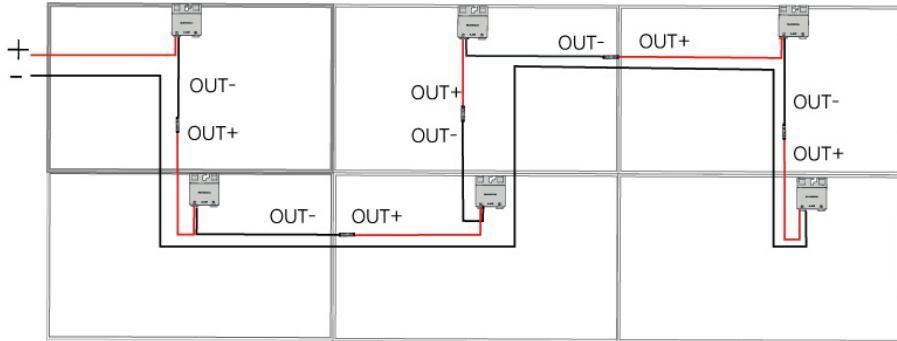

Wiring Instructions for Optimizer with Longer PV Cable

If the PV module is large in size, you may choose to use the optimizer product with longer PV cable, which eliminates the need to disassemble the module for maintenance. The wiring diagram is shown below:

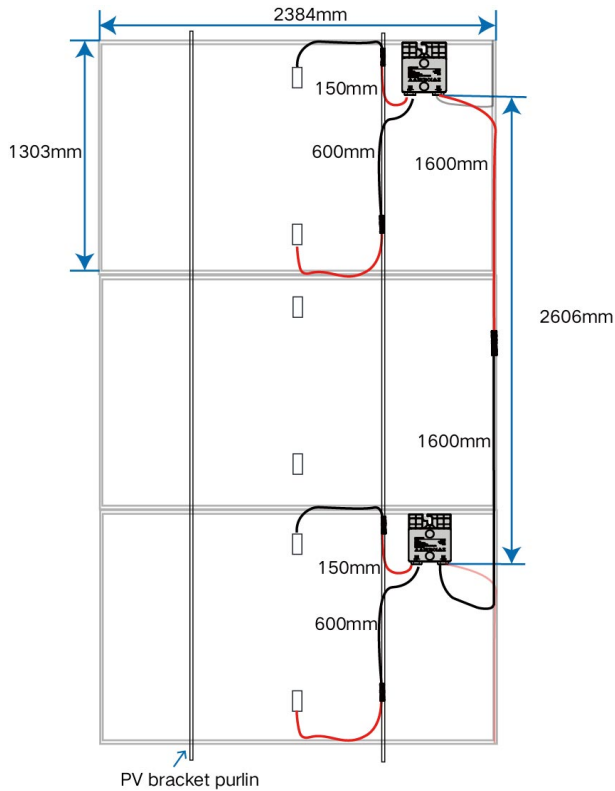

DC wiring requirements

The positive and negative DC cables of the same string should be routed side by side. The correct wiring is as shown below.

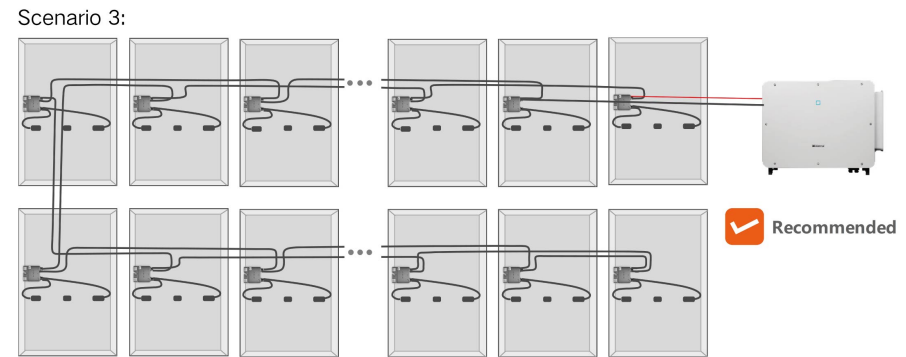
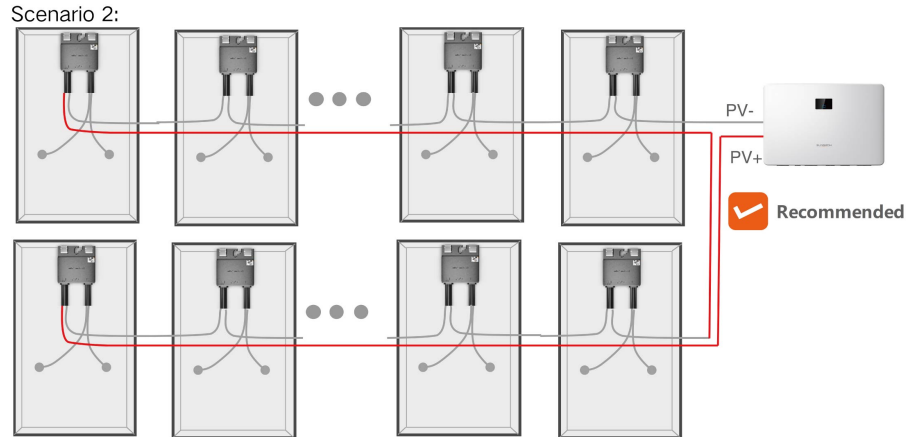
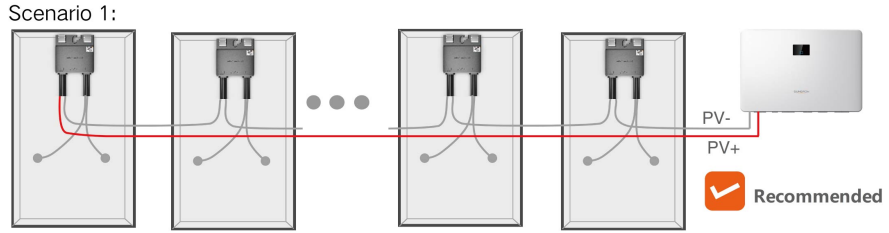

This scenario can save PV cables.

The positive and negative DC cables of the same string are not allowed to be routed separately as figure shown below.

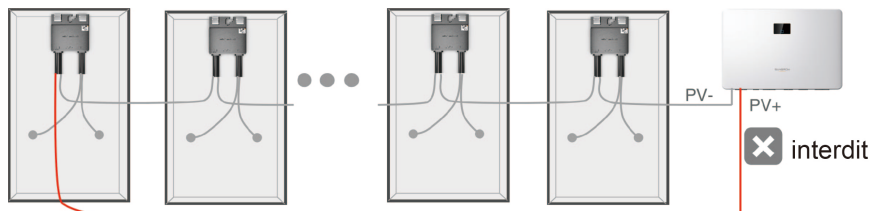

- The communication distance between the inverter and the optimizer should be $<350\text{m}$. If the distance exceeds 350m , please consult SUNGROW.

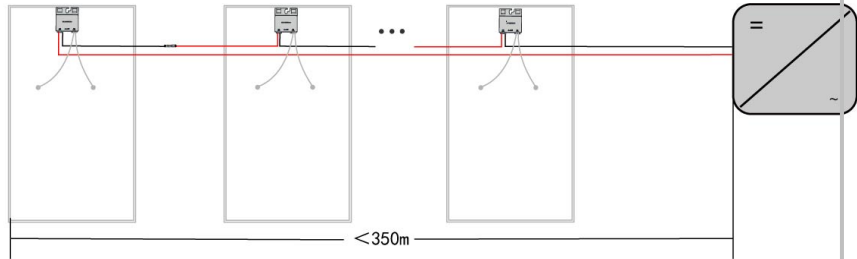

6 Commissioning

6.1 Inspection Before Commissioning

Check the following items before starting the optimizer:

- All equipment has been reliably installed.
- The DC switch of the inverter is set to "ON" and the AC circuit breaker is switched on.
- All cables are correctly properly.
- The input and output cables of all optimizers are connected with correct polarity, without reverse connection.
- Make sure that QR code labels are correctly attached to corresponding square cells on the physical layout.
- All warning signs and labels are intact and legible.
- Ensure the data logging device (WiNet-S2 or Logger1000) properly communicates with the inverter and other devices. For specific instructions, see the [iSolarCloud App User Manual](#) or [Logger1000A_Logger1000B User Manual](#).
- V2.1.6.20230411 or later versions of iSolarCloud App is used.

6.2 Set Optimizer Physical & Logical Layouts

The physical layout provides a visual representation of the installation locations and orientations of plant components, along with their corresponding optimizer units. The logical layout clearly illustrates the electrical connection topology between the optimizers and the inverters. Proper configuration of both layouts is fundamental to ensuring stable plant operation and enabling efficient O&M.

Before configuring the physical and logical layouts of the optimizers, create the PV plant via the iSolarCloud App or Web platform (<https://www.isolarcloud.com>). For detailed procedures, refer to the corresponding user manuals.

- iSolarCloud App: [iSolarCloud App User Manual](#)
- iSolarCloud: [iSolarCloud WEB 3.0 User Manual](#)

6.2.1 Method 1: Set layout by importing Excel template

It is recommended to complete the layout settings by importing an Excel layout template. For detailed instructions, refer to [Layout Setup for C&I PV Plant](#) in the [iSolarCloud WEB 3.0 User Manual](#), or scan the following QR code.



In the scenario of connection without network, the O&M personnel need to upload a configuration file containing the physical layout information of the inverter and other devices on the Web of the Logger1000 to create a plant. For details, see [Uploading Physical Layout](#) in *Logger1000A_Logger1000B User Manual*.

6.2.2 Method 2: Set layout manually

Step 1 Manually bind the optimizer in the layout by selecting the S/N.

- a. Tap **PV Module**, fill in line, column, and angle of the actual PV module, and tap **Add**.

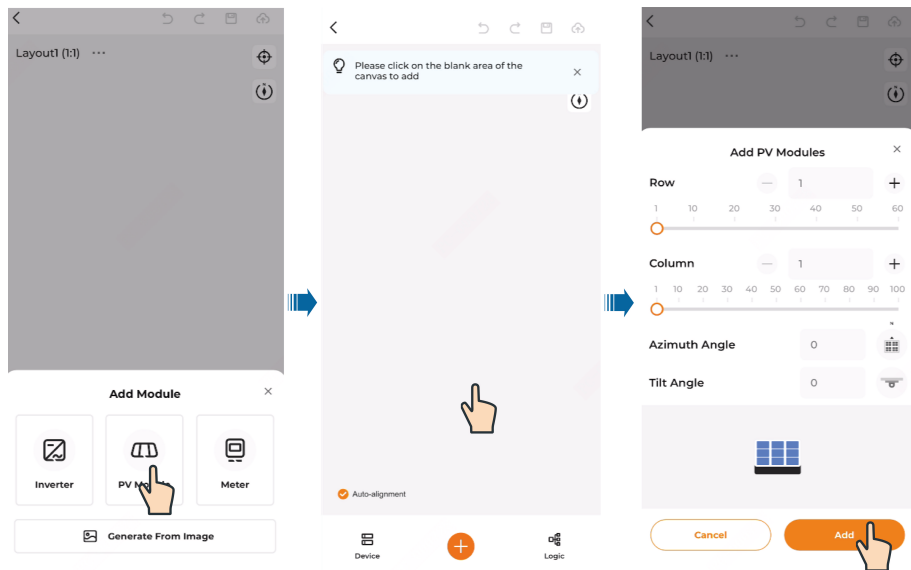

- b. The manually added PV module is not bound with an optimizer. Tap a single module, tap **Assign** at the bottom left, and select the S/N of the corresponding optimizer to bind the optimizer to the module.

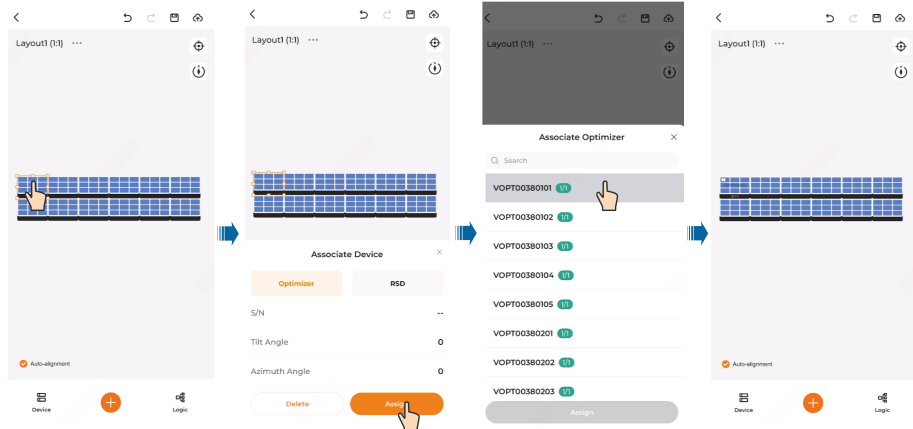

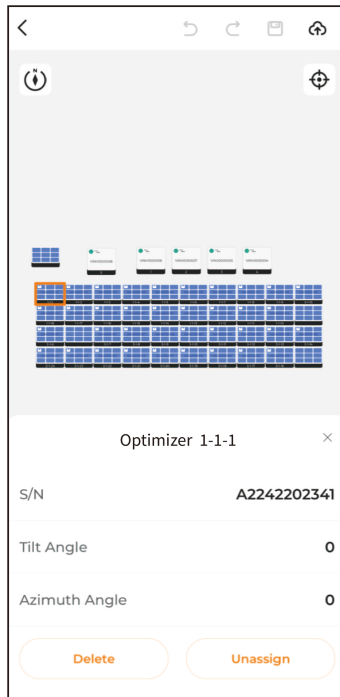

- c. If an optimizer is incorrectly bound to a PV module or the module is redundant, tap the module and select **Unbind** or **Delete**.

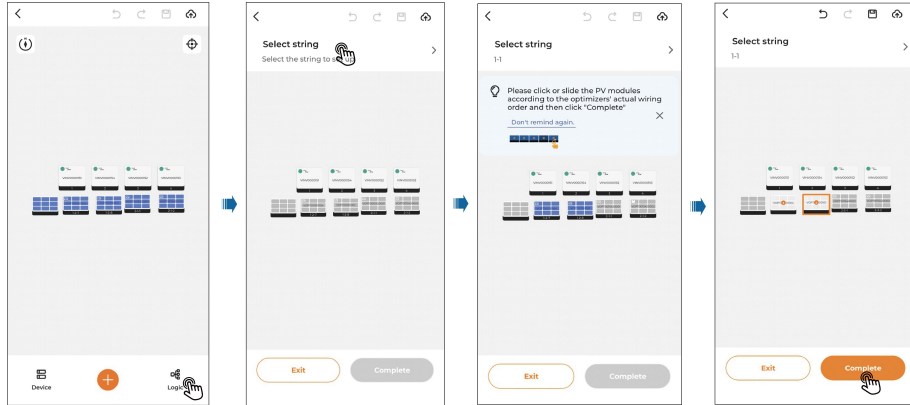

The physical layout of the optimizer is successfully set. Now set the logical layout of the optimizer.

- Step 2** To set the layout by Manual Configuration: Tap to choose the corresponding PV module and click **Select String** to form a string and determine the string number, all in compliance with the actual connection of the string.



Step 3 If you want to modify the layout, tap  and tap **Layout Settings**.

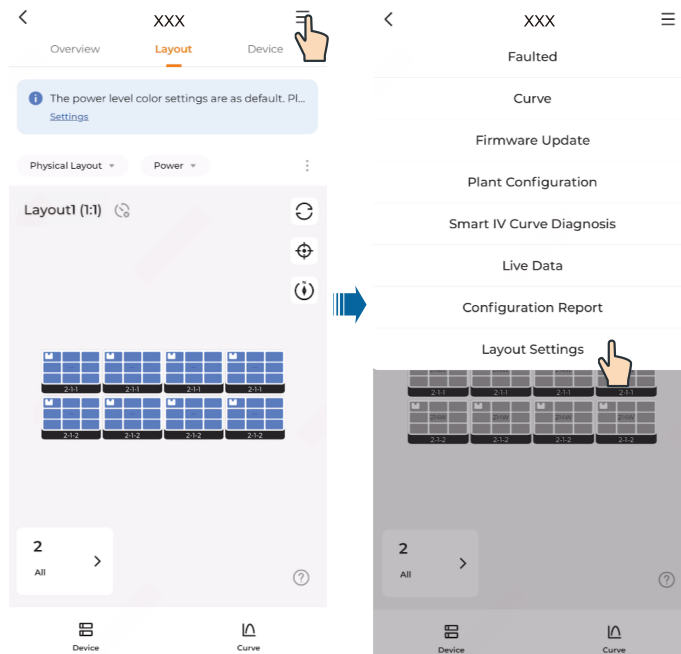

Step 4 Tap the target inverter. Choose **Settings > Optimizer Setting**, and disable **Auto Frequency Point Setting**. Then, choose **Communication Frequency Point** and select a communication frequency point. Finally, tap **Apply Settings** to effect the settings.

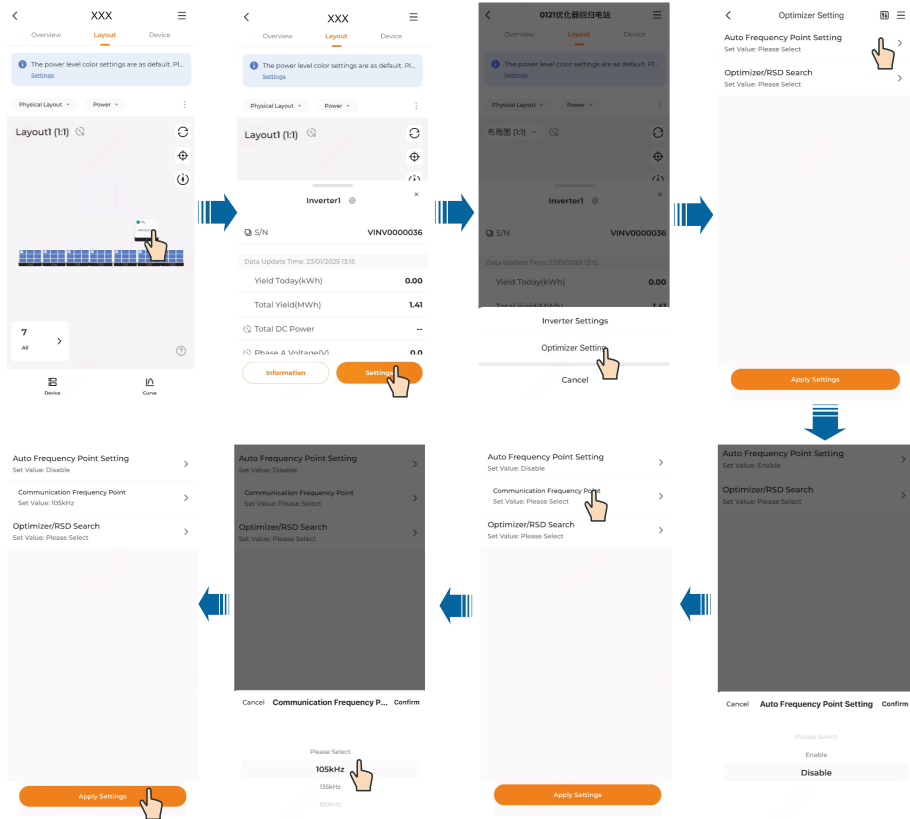

NOTICE

- **If more than one inverters are used at the same time, please set different frequency points respectively for the optimizers attached to these inverters, so as to avoid optimizer communication interference.**
- **Only distributor/installer account can modify the plant layout.**

--End

6.3 PLC Communication Setup

By default, communication between the inverter and the optimizer is disabled. After the optimizer is connected to the inverter, enable communication manually to establish the communication link.

Prerequisite

A plant is created via the iSolarCloud App, and the inverter and optimizer are added to the plant.

Step 1 Tap the plant name to open its overview.

Step 2 Tap **Device**, then select the inverter.

Step 3 Choose **Settings** from the top tabs.

Step 4 Tap **General settings**. Choose **Connect optimizer/RSD or not**, select **Connected**, then tap **Apply settings**.

Step 5 Tap **Confirm**. The App will display **Changes applied** once the setup is successful.

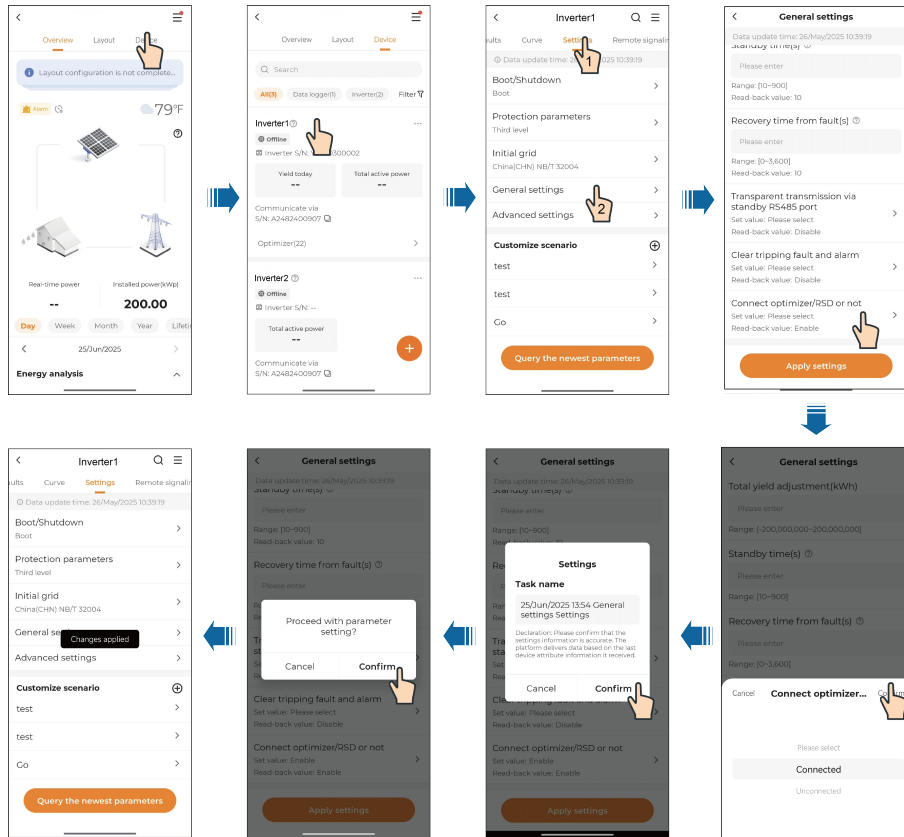

--End

6.4 Viewing Optimizer Layout

Optimizer Running Status

Judge the optimizer status according to the color of the relative PV module on the layout. Colors and status are described in the following table.

PV Module	Status	Cause
<p>Blue</p>	The optimizer is running properly	/



Red

A fault occurs to the optimizer

1. A hardware fault occurs to the optimizer
2. The optimizer software fails to upgrade
3. The PV voltage is higher than the set protection value



Grey

The optimizer is offline

1. Optimizer input cables are poorly connected
2. Fault occurs to the PV module connected to the optimizer
3. The PV module connected to the optimizer is shaded
4. Fault occurs to the optimizer



See [8.1 Troubleshooting](#) for troubleshooting methods.



If the optimizer goes offline, please:

- 1. Check if the optimizer input cables are properly connected.
- 2. Check if the voltage of the module is normal using a multimeter after powering down.
- 3. Check if the module is shaded.
- 4. Check if the voltage of the optimizer is normal using a multimeter after powering down.

The module is blue if the optimizer is running properly.

The color of a PV module depends on the power ratio range. The darker the color, the larger the power ratio and the higher the power generation efficiency of the module. The lighter the color, the smaller the power ratio, and the lower the power generation efficiency.

Color	Actual power/Peak power * 100%
	80~100%
	60~80%
	40~60%

Color	Actual power/Peak power * 100%
	20~40%
	0~20%
	Default

Layout Switching

Tap the upper left corner of the interface to switch between **Physical Layout** and **Logical Layout**.

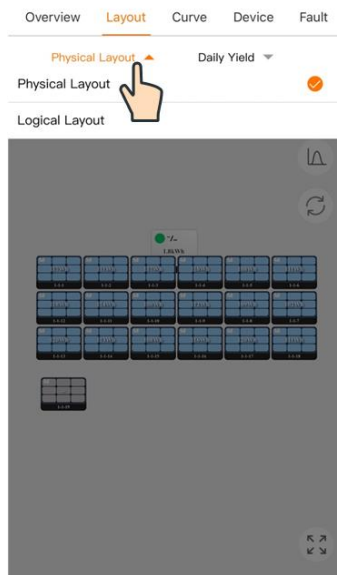

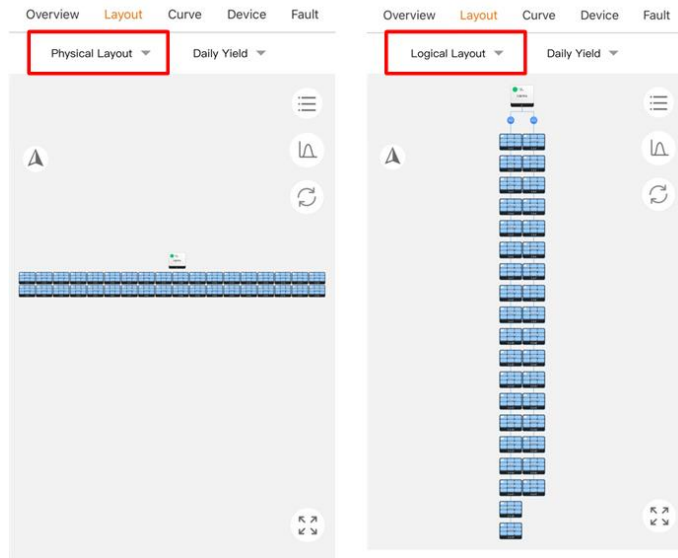

Physical layout: the actual location arrangement of the modules.

Logical layout: the sequence of modules in each string.

Viewing Module Information

1. Tap the module on the interface to view the device information and running data information of the optimizer.

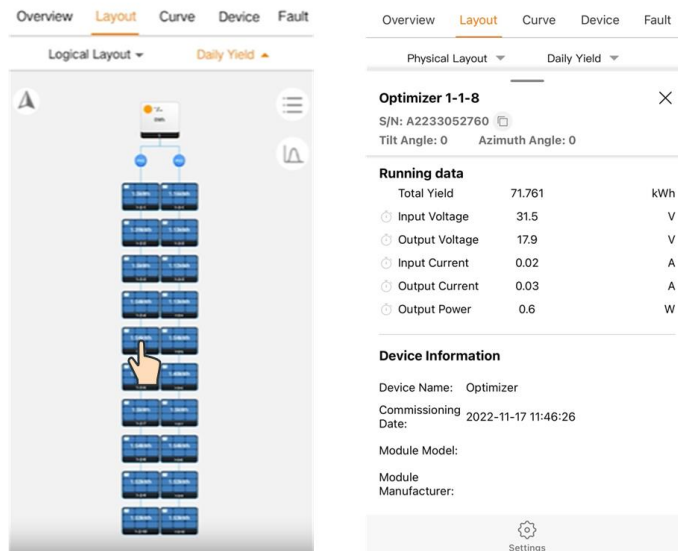

2. Tap the upper-right corner of the interface and select the needed parameter, including **Daily Yield**, **Monthly Yield**, **Annual Yield**, **Total Yield**, and **Power**. The parameter value is displayed on each module after selection. Select **Power** to refresh data in seconds.

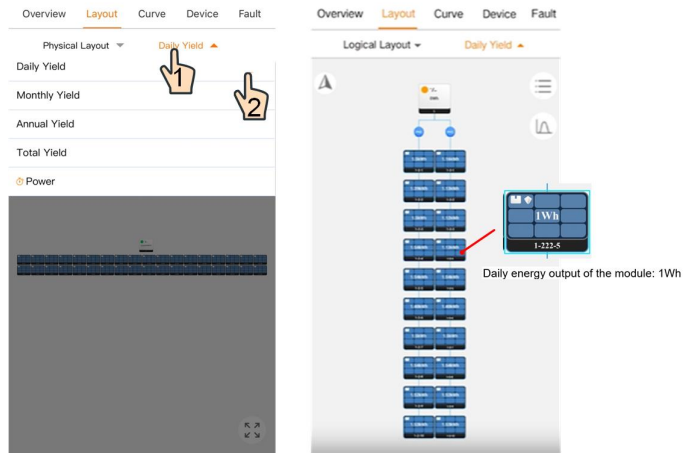

3. To view the curve of a single module, select the module, tap , and tap **Curve**.

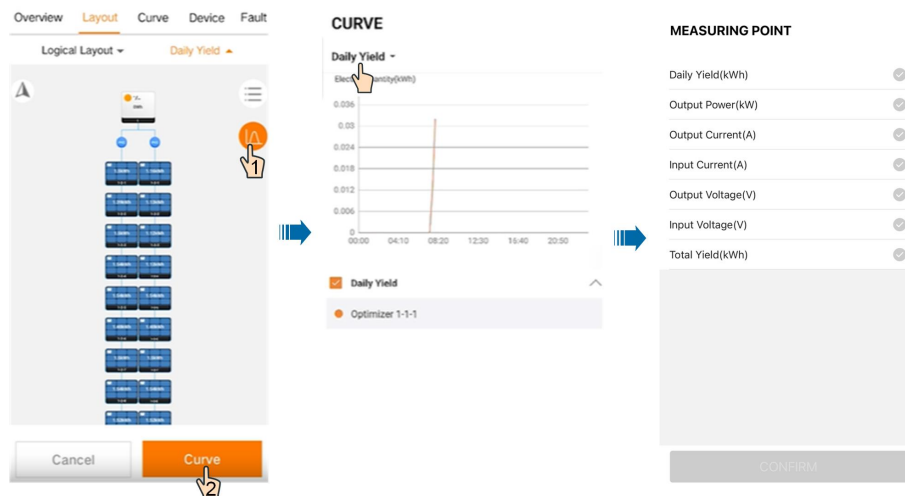

Smart IV Curve Diagnosis

 The smart IV curve diagnosis function can only be used on iSolarCloud Web.

Click  on the layout interface, click **Settings** in the upper right corner, click **PV Module Management** and click **Add**. Fill in the module configuration parameter information, determine the module to be diagnosed, and then click **Start Diagnosis**. The login password is the password used to log in to iSolarCloud.

NOTICE

- **Smart IV curve diagnosis is not supported in partial MPPT deployment scenario.**
- **At most six modules can be selected in one round of smart IV curve diagnosis.**

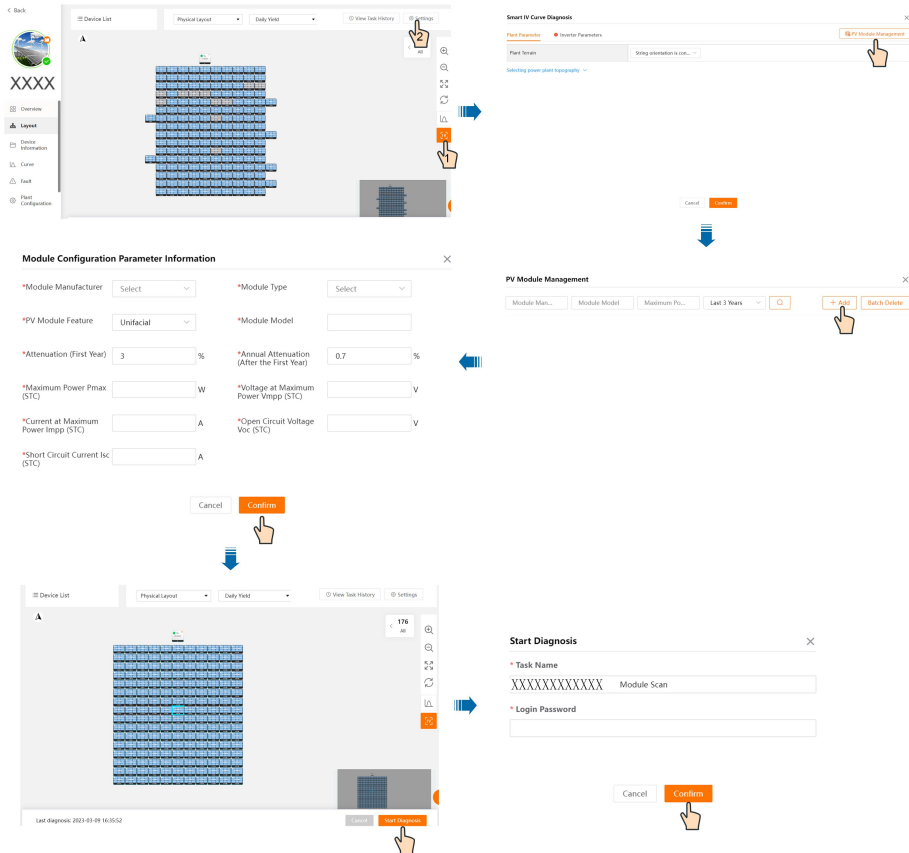

The diagnostic result of the module is shown in the figure below.

The module status is displayed on the interface. Click **View** on the right of a module to view the detailed results, including the general information, IV curve, and PV curve. To export the diagnostic report, click **New Report** in the upper right corner.

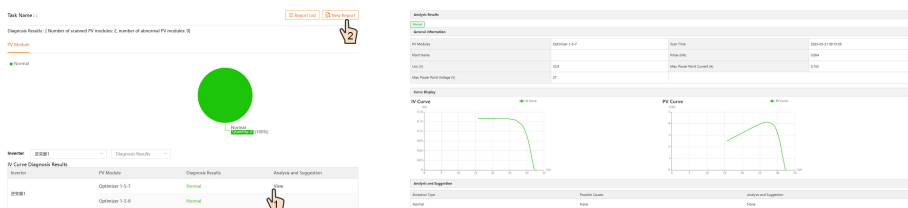

7 Optimizer Decommissioning

7.1 Disconnecting Optimizer

Prerequisite

⚠ CAUTION

Danger of burns!
Even if the product is shut down, it may still be hot and cause burns. Wear protective gloves before operating the optimizer after it cools down.

- Step 1** The inverter connected to the optimizer is powered down.
- Step 2** Ensure that the DC cable is current-free via a current clamp.
- End

7.2 Dismantling Optimizer

Prerequisite

⚠ CAUTION

Risk of burn injuries and electric shock!
After the upstream and downstream devices of the optimizer are powered down, measure the voltage and current with professional instrument. Only when there is no voltage nor current can operators who wear protective equipment operate and maintain the optimizer.

- Step 1** Refer to [5 Electrical Connection](#) to disconnect all cables of the optimizer in reverse steps. In particular, when removing the DC connector, use an wrench to loosen the locking parts and install waterproof plugs.

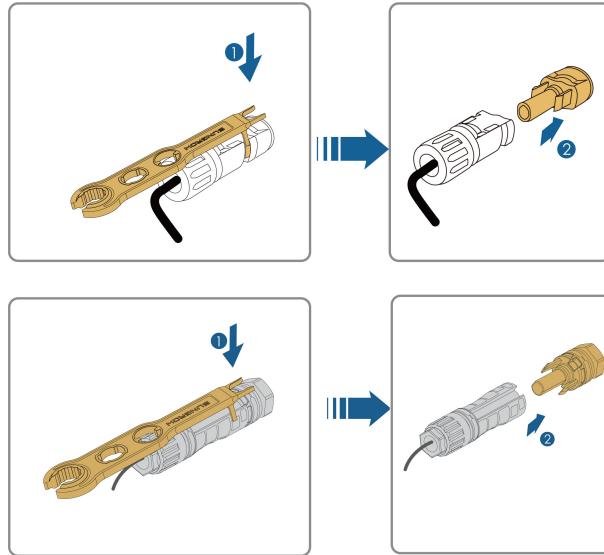

Step 2 If the optimizer will be used again in the future, please refer to [3.2 Storage](#) for proper storage.

--End

7.3 Disposal of Optimizer

Users take the responsibility for the disposal of the optimizer.

⚠ WARNING

Please scrap the optimizer in accordance with relevant local regulations and standards to avoid property losses or casualties.

NOTICE

Some parts of the optimizer may cause environmental pollution. Please dispose of them in accordance with the disposal regulations for electronic waste applicable at the installation site.

8 Troubleshooting and Maintenance

8.1 Troubleshooting

Once a fault occurs to the optimizer, the fault information is displayed on the App.

Fault Code	Fault Name	Possible Cause	Corrective Method
4	Input overvoltage	The PV voltage is higher than the set protection value	1. Please check if the cables between the optimizer and PV module are reliably and properly connected. 2. Please check if the open-circuit voltage of the PV module, to which the optimizer is connected, exceeds the maximum input voltage allowed for the optimizer, or if the module's open-circuit voltage is abnormal.
512	Hardware fault	A hardware fault occurs to the optimizer	1. Please disconnect the PV module connected to the abnormal optimizer. 2. Please contact SUNGROW Customer Service to have the optimizer replaced.
1024	Update failed	The optimizer software fails to upgrade	Please check if the light conditions are normal. It is suggested to perform optimizer update again at noon when the light is good.

8.2 Maintenance

8.2.1 Maintenance Notices

⚠ DANGER

Risk of device damage or personal injury due to incorrect service!

- Be sure to use special insulation tools when perform high-voltage operations
- Before maintaining the optimizer, first cut off the power input and the power output, and measure the voltage and current with professional measuring instrument. Only when there is no voltage nor current can operators who wear protective equipment operate and maintain the optimizer.
- Even if the optimizer is shut down, it may still be hot and cause burns. Operating the optimizer with protective gloves after it cools down.

⚠ WARNING

If a fault occurs during operation, be sure to re-power the optimizer after the fault is cleared. Otherwise, the fault may expand, or the device may be damaged.

⚠ CAUTION

To prevent misuse or accidents caused by unrelated personnel, post prominent warning signs or demarcate safety warning areas around the optimizer to prevent accidents caused by misuse.

NOTICE

As the optimizer contains no component parts that can be maintained, never open its enclosure or replace any internal components.

To avoid the risk of electric shock, do not perform any other maintenance operations beyond this manual. If necessary, contact SUNGROW for maintenance. Otherwise, the losses caused are not covered by the warranty.

NOTICE

Touching the PCB or other static sensitive components may cause damage to the device.

- Do not touch the circuit board unnecessarily.
- Observe the regulations to protect against electrostatic and wear an anti-static wrist strap.

8.2.2 Routine Maintenance

The maintenance item and period of the device are listed in the table below.

Check Item	Check Method	Maintenance Period
Running status	Check whether the device operates normally.	Once every six months

Check Item	Check Method	Maintenance Period
	Check whether there is abnormal noise or sound during operation.	
Electrical connection	Check whether cables are loose or fall off. Check whether cables are damaged.	Once every six months to a year

8.2.3 Rapid Shutdown

Support module level rapid shutdown. 20s module-level rapid shutdown for residential application and 30s module-level rapid shutdown for C&I application.

Triggering methods of rapid shutdown:

- Method 1: Turn off the AC circuit breaker between the inverter and the grid.
- Method 2: Connect a rapid shutdown button to the RSD and GND ports of the inverter to form a circuit. Press this button to trigger a rapid shutdown (for details about the RSD port, see the corresponding inverter user manual). Release the button for the inverter to start operation again.
- Method 3: Connect the rapid shutdown button to any DI port (except DI5) on the Logger1000. Then, log in to the Logger1000 web system and configure the DI port parameters. After this, rapid shutdown can be triggered by pressing the rapid shutdown button.
- Method 4: Enable "AFCl-Triggered Rapid Shutdown" manually. Then, in case of an arc fault in the inverter, a "rapid shutdown" signal will be sent to the optimizer and the inverter will execute the "press to shut down" and "rapid shutdown" commands simultaneously.

NOTICE

- **The rapid shutdown function is not supported if optimizers are configured for partial MPPT deployment scenario.**
- **The optimizer's rapid shutdown function is not available for SH3.0/3.6/4.0/5.0/6.0RS inverters.**
- **Please check regularly whether the rapid shutdown function is normal.**
- **Rapid shutdown cannot be achieved by turning off the inverter's DC switch.**

8.2.4 Replacing Optimizer

Step 1 The inverter connected to the optimizer is powered off.

Step 2 Ensure that the DC cable is current-free via a current clamp.

Step 3 Disconnect all cables of the optimizer. In particular, when removing the DC connector, use an wrench to loosen the locking parts and install waterproof plugs.

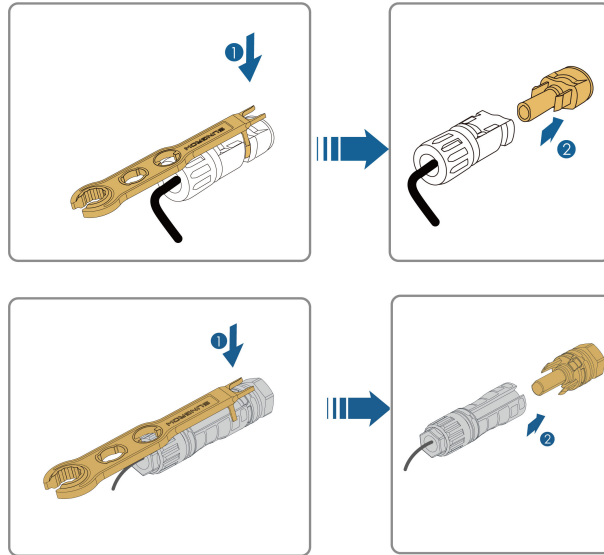

Step 4 Replace the optimizer. Refer to [5.4 Connecting to PV Module](#) to install the optimizer and finish the cable connections.

Step 5 Power on the inverter. Log in to the iSolarCloud App. Tap the plant name from the plant list on the **Monitoring** screen. Then, on the **Device** screen, choose “optimizer” at the bottom of the inverter card. Find the S/N of the optimizer to be replaced, and tap **Replace** below.

Enter the S/N of the new optimizer, or tap  to scan the QR code on its enclosure. Then, tap **Start Replacement**.

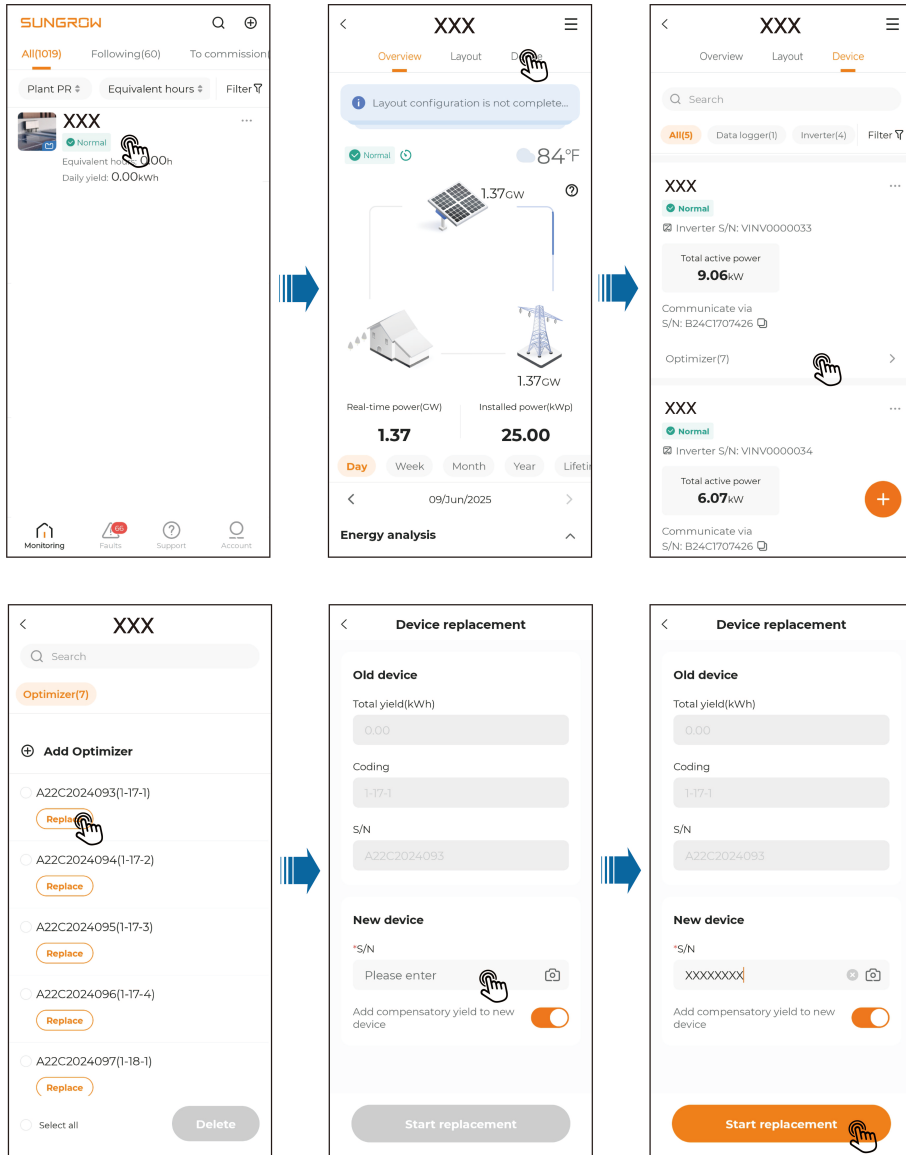

Set the layout again after replacement. Please refer to **Setting Physical Layout of Optimizer on iSolarCloud App** in [6.2 Set Optimizer Physical & Logical Layouts](#) for detailed instructions.

--End

9 Appendix

9.1 Technical Data

Parameter Name	SP600S
Input	
Recommend input power	450 W - 695 W*
Max. input voltage	80 V
MPPT voltage range	8 V – 80 V
Max. DC short-circuit current (Isc)	20 A
Overvoltage category	II
Output	
Rated output power	600 W
Max. output voltage	80 V
Max. output current	16 A
Bypass working mode	Yes
Safety output voltage per optimizer	1 V
Efficiency	
Max. efficiency	99.5 %
Weighted efficiency	99.0 %
General Data	
Dimensions (W*H*D)	86 x 108 x 25 mm (3.4 x 4.3 x 1.0 inch)
Weight (including cables)	0.5 kg (1.1 lb.)
Degree of protection	IP68
Allowable relative humidity range (non-condensing)	0 % - 100 %

Parameter Name	SP600S
Operating ambient temperature range	-40°C - 85°C
Max. operating altitude	4000 m
Mounting Method	Push-in or bolt installation
Communication	PLC(< 350 m)
PV input / output connector	MC4 or MC4 Compatible
PV wire length (short version)	Input : 150 mm (PV+) 150 mm (PV-) Output : 1200 mm
PV wire length (long version)	Input : 600 mm (PV+) 150 mm (PV-) Output : 1600 mm
Compatible products**	SG2.0 / 2.5 / 3.0RS-S SG3.0 / 3.6 / 4.0 / 5.0 / 6.0 / 8.0 / 9.0 / 10RS SH3.0 / 3.6 / 4.0 / 5.0 / 6.0RS SG5.0 / 6.0 / 7.0 / 8.0 / 10 / 12 / 15 / 17 / 20RT-P2 SG25 / 30 / 33 / 36 / 40 / 50 / 125CX-P2

* The rated power of modules under standard test conditions (STC) is recommended to be within 5% higher than the rated input power of the optimizer. If the rated power of modules under standard test conditions (STC) is higher than 630 W, the DC/AC ratio should be higher than 1.2.

** Please consult Sungrow before placing an order on optimizers and compatible inverters.

9.2 Quality Assurance

When product faults occur during the warranty period, SUNGROW will provide free service or replace the product with a new one.

The software security update period for this product aligns with the warranty period. During the warranty, security patches or updates will be provided if any vulnerabilities or compatibility issues are identified.

Evidence

During the warranty period, the customer shall provide the product purchase invoice and date. In addition, the trademark on the product shall be undamaged and legible. Otherwise, SUNGROW has the right to refuse to honor the quality guarantee.

Conditions

- After replacement, unqualified products shall be processed by SUNGROW.
- The customer shall give SUNGROW a reasonable period to repair the faulty device.

Exclusion of Liability

In the following circumstances, SUNGROW has the right to refuse to honor the quality guarantee:

- The free warranty period for the whole machine/components has expired.
- The device is damaged during transport.
- The device is incorrectly installed, refitted, or used.
- The device operates in harsh conditions beyond those described in this manual.
- The fault or damage is caused by installation, repairs, modification, or disassembly performed by a service provider or personnel not from SUNGROW.
- The fault or damage is caused by the use of non-standard or non-SUNGROW components or software.
- The installation and use range are beyond stipulations of relevant international standards.
- The damage is caused by unexpected natural factors.

For faulty products in any of above cases, if the customer requests maintenance, paid maintenance service may be provided based on the judgment of SUNGROW.



Product data such as product dimensions are subject to change without prior notice. The latest documentation from SUNGROW should take precedence in case of any deviation.

9.3 Contact Information

In case of questions about this product, please contact us. We need the following information to provide you the best assistance:

- Model of the device
- Serial number of the device
- Fault code/name
- Brief description of the problem

For detailed contact information, please visit: <https://en.SUNGROWpower.com/contactUS>

SUNGROW

Sungrow Power Supply Co., Ltd.

www.sungrowpower.com