

User Manual

1-Phase PV Grid-Connected Inverter

SG7.5RS-L2 / SG8.0RS-L2 / SG10RS-L2



All Rights Reserved

All Rights Reserved

No part of this document can be reproduced in any form or by any means without the prior written permission of Sungrow Power Supply Co., Ltd (hereinafter "SUNGROW").

Trademarks

SUNGROW and other SUNGROW trademarks used in this manual are owned by SUNGROW.

All other trademarks or registered trademarks mentioned in this manual are owned by their respective owners.

Software Licenses

- It is prohibited to use data contained in firmware or software developed by SUNGROW, in part or in full, for commercial purposes by any means.
- It is prohibited to perform reverse engineering, cracking, or any other operations that compromise the original program design of the software developed by SUNGROW.

About This Manual

The manual mainly contains the product information, as well as guidelines for installation, operation, and maintenance. The manual does not include complete information about the photovoltaic (PV) system. Readers can get additional information at www.sungrowpower.com or on the webpage of the respective component manufacturer.

Validity

This manual is valid for the following model of low-power grid-connected PV string inverters:

- SG7.5RS-L2
- SG8.0RS-L2
- SG10RS-L2

It will be referred to as "inverter" hereinafter unless otherwise specified.

Target Group

This manual is intended for professional technicians who are responsible for installation, operation, and maintenance of inverters, and users who need to check inverter parameters.

The inverter must only be installed by professional technicians. The professional technician is required to meet the following requirements:

- Know electronic, electrical wiring and mechanical expertise, and be familiar with electrical and mechanical schematics.
- Have received professional training related to the installation and commissioning of electrical equipment.
- Be able to quickly respond to hazards or emergencies that occur during installation and commissioning.
- Be familiar with local standards and relevant safety regulations of electrical systems.
- Read this manual thoroughly and understand the safety instructions related to operations.

How to Use This Manual

Please read this manual carefully before using the product and keep it properly at a place for easy access.

All contents, pictures, marks, and symbols in this manual are owned by SUNGROW. No part of this document may be reprinted by the non-internal staff of SUNGROW without written authorization.

Contents of this manual may be periodically updated or revised, and the actual product purchased shall prevail. Users can obtain the latest manual from support.sungrowpower.com or sales channels.

Security Declaration

For details on the product's network security vulnerability response process and vulnerability disclosure, please visit the following website: <https://en.sungrowpower.com/security-vulnerability-management>.

For more information on network security, please refer to the user manual of the communication module or the Data Logger that comes with the product.

Symbols

This manual contains important safety instructions, which are highlighted with the following symbols, to ensure personal and property safety during usage, or to help optimize the product performance in an efficient way.

Please carefully understand the meaning of these warning symbols to better use the manual.

DANGER

Indicates high-risk potential hazards that, if not avoided, may lead to death or serious injury.

WARNING

Indicates moderate-risk potential hazards that, if not avoided, may lead to death or serious injury.

CAUTION

Indicates low-risk potential hazards that, if not avoided, may lead to minor or moderate injury.

NOTICE

Indicates potential risks that, if not avoided, may lead to device malfunctions or financial losses.



“NOTE” indicates additional information, emphasized contents or tips that may be helpful, e.g., to help you solve problems or save time.

Contents

All Rights Reserved.....	I
About This Manual.....	II
1 Safety Instructions.....	1
1.1 Unpacking and Inspection.....	2
1.2 Installation Safety.....	3
1.3 Electrical Connection Safety.....	3
1.4 Operation Safety.....	5
1.5 Maintenance Safety.....	6
1.6 Disposal Safety.....	7
2 Product Description.....	8
2.1 System Introduction.....	8
2.2 Product Introduction.....	10
2.3 Symbols on Product.....	12
2.4 LED Panel.....	13
2.5 Circuit Diagram.....	14
2.6 Function Description.....	15
3 Unpacking and Storage.....	20
3.1 Unpacking and Inspection.....	20
3.2 Inverter Storage.....	20
4 Mechanical Mounting.....	22
4.1 Safety During Mounting.....	22
4.2 Location Requirements.....	23
4.2.1 Installation Environment Requirements.....	24
4.2.2 Carrier Requirements.....	25
4.2.3 Angle Requirements.....	26
4.2.4 Clearance Requirements.....	26
4.3 Tools and Instruments.....	27
4.4 Moving the Inverter.....	29
4.5 Installing the Inverter.....	29
5 Electrical Connection.....	32
5.1 Safety Instructions.....	32
5.2 Terminal Description.....	34
5.3 Electrical Connection Overview.....	36
5.4 External Protective Grounding Connection.....	37

5.4.1 External Protective Grounding Requirements.....	38
5.4.2 Connection Procedure.....	38
5.5 AC Cable Connection.....	40
5.5.1 AC Side Requirements.....	40
5.5.2 Connecting the AC Cable.....	40
5.6 DC Cable Connection.....	43
5.6.1 PV Input Configuration.....	45
5.6.2 Assembling the PV Connectors.....	46
5.6.3 Installing the PV Connectors.....	47
5.7 Wireless Communication Module Connection.....	48
5.8 RS485 Connection.....	49
5.9 Meter Connection.....	50
5.10 CT Connection.....	51
6 Commissioning.....	53
6.1 Inspection Before Commissioning.....	53
6.2 Powering on the System.....	53
7 iSolarCloud App.....	55
7.1 About iSolarCloud.....	55
7.2 Install iSolarCloud.....	56
7.3 User Roles.....	57
7.4 Device Commissioning.....	57
8 System Decommissioning.....	58
8.1 Disconnecting the Inverter.....	58
8.2 Dismantling the Inverter.....	58
8.3 Disposal of Inverter.....	59
9 Troubleshooting and Maintenance.....	60
9.1 Troubleshooting.....	60
9.2 Maintenance.....	67
9.2.1 Maintenance Notices.....	67
9.2.2 Routine Maintenance.....	68
10 Appendix.....	69
10.1 Technical Data.....	69
10.2 Quality Assurance.....	72
10.3 Contact Information.....	73

1 Safety Instructions

When installing, commissioning, operating, and maintaining the product, strictly observe the labels on the product and the safety requirements in the manual. Incorrect operation or work may cause:

- Injury or death to the operator or a third party.
- Damage to the product and other properties.

WARNING

- **Do not perform any operation on the product (including but not limited to, handling, installing, powering on, or maintaining the product, performing electrical connection, and working at heights) in harsh weather conditions, such as thunder and lightning, rain, snow, and Level 6 or stronger winds. SUNGROW shall not be held liable for any damage to the device due to force majeure, such as earthquakes, floods, volcanic eruptions, mudslides, lightning strikes, fires, wars, armed conflicts, typhoons, hurricanes, tornadoes, and other extreme weathers.**
- **In case of fire, evacuate from the building or product area and call the fire alarm. Re-entry into the burning area is strictly prohibited under any circumstances.**

NOTICE

- **Tighten the screws with the specified torque using tools when fastening the product and terminals. Otherwise, the product may be damaged. And the damage caused is not covered by the warranty.**
- **Learn how to use tools correctly before using them to avoid hurting people or damaging the device.**
- **Maintain the device with sufficient knowledge of this manual and use proper tools.**



- The safety instructions in this manual are only supplements and cannot cover all the precautions that should be followed. Perform operations considering actual onsite conditions.
- SUNGROW shall not be held liable for any damage caused by violation of general safety operation requirements, general safety standards, or any safety instruction in this manual.
- When installing, operating, and maintaining the product, comply with local laws and regulations. The safety precautions in this manual are only supplements to local laws and regulations.
- During the product transport, installation, wiring, maintenance, etc., the materials and tools prepared by users must meet the requirements of applicable local laws and regulations, safety standards, and other specifications. SUNGROW shall not be held liable for any damage to the product caused by the adoption of materials and tools that fail to meet the above-mentioned requirements.
- Operations on the product, including but not limited to, handling, installing, wiring, powering on, maintenance, and use of the product, must not be performed by unqualified personnel. SUNGROW shall not be held liable for any damage to the product resulting from operations done by unqualified personnel.
- Where the transport of the product is arranged by users, SUNGROW shall not be held liable for any damage to the product that is caused by users themselves or the third-party transport service providers designated by the users.
- SUNGROW shall not be held liable for any damage to the product caused by the negligence, intent, fault, improper operation, and other behaviors of users or third-party organizations.
- SUNGROW shall not be held liable for any damage to the product arising from reasons unrelated to SUNGROW.

1.1 Unpacking and Inspection

WARNING

- **Check all safety signs, warning labels and nameplates on devices.**
- **The safety signs, warning labels and nameplates must be clearly visible and cannot be removed or covered before the device is decommissioned.**

NOTICE

After receiving the product, check whether the appearance and structural parts of the device are damaged, and check whether the packing list is consistent with the actual ordered product. If there are problems with the above inspection items, do not install the device and contact your distributor first. If the problem persists, contact SUNGROW in time.

1.2 Installation Safety

⚠ DANGER

- Make sure there is no electrical connection before installation.
- Before drilling, avoid the water and electricity wiring in the wall.

⚠ CAUTION

Improper installation may cause personal injury!

- If the product supports hoisting transport and is hoisted by hoisting tools, no one is allowed to stay under the product.
- When moving the product, be aware of the product weight and keep the balance to prevent it from tilting or falling.

NOTICE

Before operating the product, must check and ensure that tools to be used have been maintained regularly.

1.3 Electrical Connection Safety

⚠ DANGER

- Before electrical connections, please make sure that the inverter is not damaged, otherwise it may cause danger!
- Before electrical connections, please make sure that the inverter switch and all switches connected to the inverter are set to "OFF", otherwise electric shock may occur!

⚠ DANGER

The PV string will generate lethal high voltage when exposed to sunlight.

- Operators must wear proper personal protective equipment during electrical connections.
- Must ensure that cables are voltage-free with a measuring instrument before touching DC cables.
- Respect all safety instructions listed in relevant documents about PV strings.
- The inverter must not be connected to a PV string that requires positive or negative grounding.

⚠ DANGER

Danger to life due to a high voltage inside the inverter!

- Be sure to use special insulation tools during cable connections.
- Note and observe the warning labels on the product, and perform operations strictly following the safety instructions.
- Respect all safety instructions listed in this manual and other pertinent documents.

⚠ WARNING

Damage to the product caused by incorrect wiring is not covered by the warranty.

- Electrical connection must be performed by professionals.
- All cables used in the PV generation system must be firmly attached, properly insulated, and adequately dimensioned.

⚠ WARNING

- Check the positive and negative polarity of the PV strings, and connect the PV connectors to corresponding terminals only after ensuring polarity correctness.
- During the installation and operation of the inverter, please ensure that the positive or negative poles of PV strings do not short-circuit to the ground. Otherwise, an AC or DC short-circuit may occur, resulting in equipment damage. The damage caused by this is not covered by the warranty.
- Do not connect any load between the inverter and the AC circuit breaker directly connected to it, so as to prevent the switch from tripping by mistake.
- Determine the specifications of AC circuit breakers strictly in compliance with the applicable local laws and regulations and safety standards or the recommendation by SUNGROW. Otherwise, the switch may not open in time in the event of something abnormal, which may then lead to safety incidents.

NOTICE

Comply with the safety instructions related to PV strings and the regulations related to the local grid.

1.4 Operation Safety

⚠ DANGER

When routing cables, ensure a distance of at least 30 mm between the cables and heat-generating components or areas to protect the insulation layer of cables from aging and damage.

When the product is working:

- Do not touch the product enclosure.
- It is strictly forbidden to plug and unplug any connector on the inverter.
- Do not touch any wiring terminal of the inverter. Otherwise, electric shock may occur.
- Do not disassemble any parts of the inverter. Otherwise, electric shock may occur.
- It is strictly forbidden to touch any hot parts of the inverter (such as the heat sink). Otherwise, it may cause burns.
- Do not connect or remove any battery. Otherwise, electric shock may occur.
- Do not connect or remove any PV string or any PV module in a string. Otherwise, electric shock may occur.
- If the inverter is equipped with a DC switch, do not operate it. Otherwise, it may cause device damage or personal injury.

Do not take other actions, such as setting parameters or cutting off power, during the process of inverter firmware update, to avoid update failure.

1.5 Maintenance Safety

DANGER

Risk of inverter damage or personal injury due to incorrect service!

- Before maintenance, disconnect the AC circuit breaker on the grid side and then the DC switch. If a fault that may cause personal injury or device damage is found before maintenance, disconnect the AC circuit breaker and wait until the night before operating the DC switch. Otherwise, a fire inside the product or an explosion may occur, causing personal injuries.
- After the inverter is powered off for 10 minutes, measure the voltage and current with professional instrument. Only when there is no voltage nor current can operators who wear protective equipment operate and maintain the inverter.
- Even if the inverter is shut down, it may still be hot and cause burns. Wear protective gloves before operating the inverter after it cools down.

DANGER

Touching the power grid or the contact points and terminals on the inverter connected to the power grid may lead to electric shock!

- The power grid side may generate voltage. Always use a standard voltmeter to ensure that there is no voltage before touching.

CAUTION

To prevent misuse or accidents caused by unrelated personnel, post prominent warning signs or demarcate safety warning areas around the product.

NOTICE

To avoid the risk of electric shock, do not perform any other maintenance operations beyond those described in this manual. If necessary, contact your distributor first. If the problem persists, contact SUNGROW. Otherwise, the losses caused is not covered by the warranty.

NOTICE

- If the paint on the inverter enclosure falls or rusts, repair it in time. Otherwise, the inverter performance may be affected.
- Do not use cleaning agents to clean the inverter. Otherwise, the inverter may be damaged, and the loss caused is not covered by the warranty.
- As the inverter contains no parts that can be maintained, never open the enclosure of the inverter or replace any internal components without authorization. Otherwise, the loss caused is not covered by the warranty.
- Do not open the maintenance door in rainy or snowy weather. If it is inevitable, take proper protective measures to avoid the ingress of rainwater and snow into the maintenance compartment; otherwise, the product's operation may be affected.
- Before closing the maintenance door, check whether there is any object left inside the maintenance compartment, such as screws, tools, etc.
- It is recommended for users to use cable sheathing to protect the AC cable. If the cable sheathing is used, make sure it is positioned inside the maintenance compartment.

1.6 Disposal Safety

 WARNING

Please scrap the product in accordance with relevant local regulations and standards to avoid property losses or casualties.

2 Product Description

2.1 System Introduction

The inverter is a transformerless 1-phase PV grid-connected inverter. As an integral component in the PV power system, the inverter is designed to convert the direct current power generated from the PV modules into grid-compatible AC current and feeds the AC current to the utility grid.

⚠ WARNING

- The inverter must only be operated with PV strings with class II protection in accordance with IEC 61730, application class A. It is not allowed for the positive pole or the negative pole of the PV strings to be grounded. This can cause damage to the inverter.
- Do not connect any local load between the inverter and the AC circuit breaker.

NOTICE

The inverter applies only to the scenarios described in this manual.

The intended usage of the inverter is illustrated in the following figure.

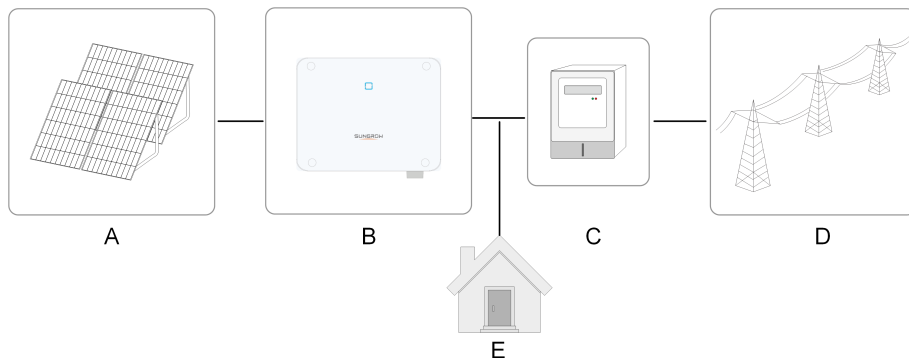
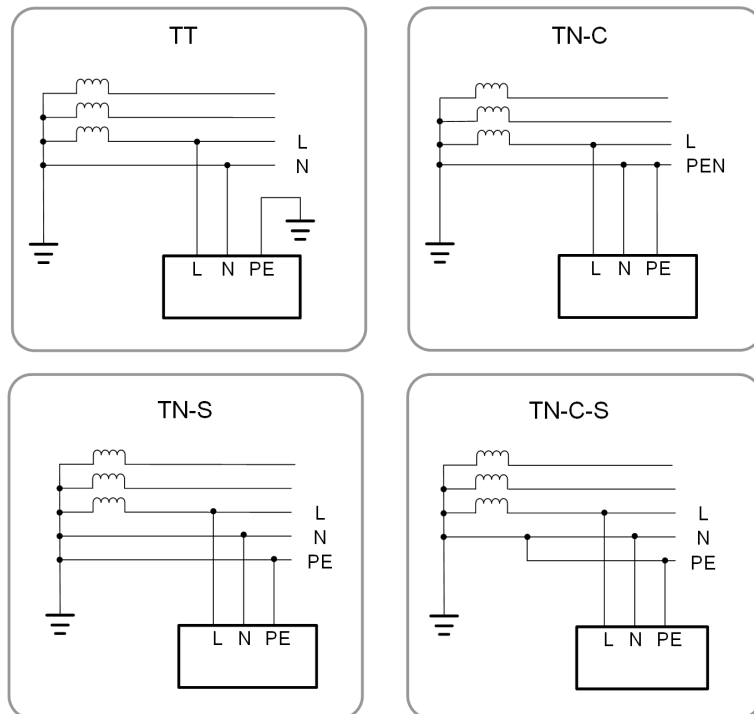

Figure 2-1 Inverter Application in PV Power System

Item	Description	Note
A	PV strings	Compatible with monocrystalline silicon, polycrystalline silicon, and thin-film modules without grounding.

Item	Description	Note
B	Inverter	SG7.5RS-L2, SG8.0RS-L2, SG10RS-L2.
C	Metering device	Meter cupboard with power distribution system.
D	Utility grid	TT, TN-C, TN-S, TN-C-S.
E	Loads	House loads that consume electricity.

The following figure shows the common grid configurations.



To meet the demand of users in different regions, connection to a split-phase grid system is supported for this inverter, as shown below. When the inverter is used in a split-phase grid system, ensure that the grounding detection function is disabled. In addition, the PV system must comply with [5.4.1 External Protective Grounding Requirements](#).

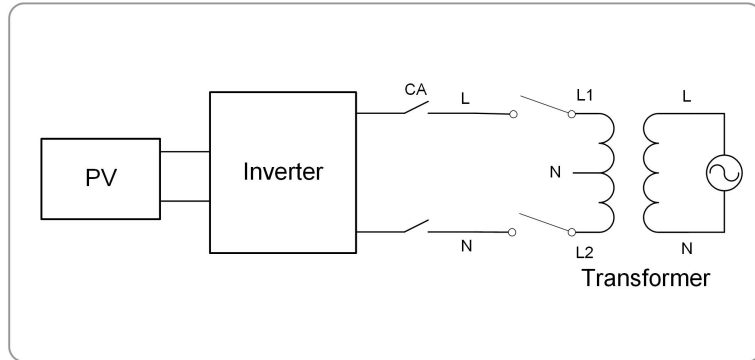

2.2 Product Introduction

Model Description

The model description is as follows (take SG7.5RS-L2 as an example):

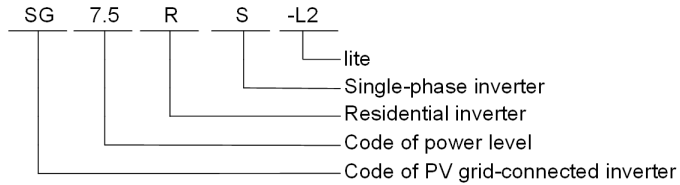

Appearance

The following figure shows the appearance of the inverter. The image shown here is for reference only. The actual product received may differ.

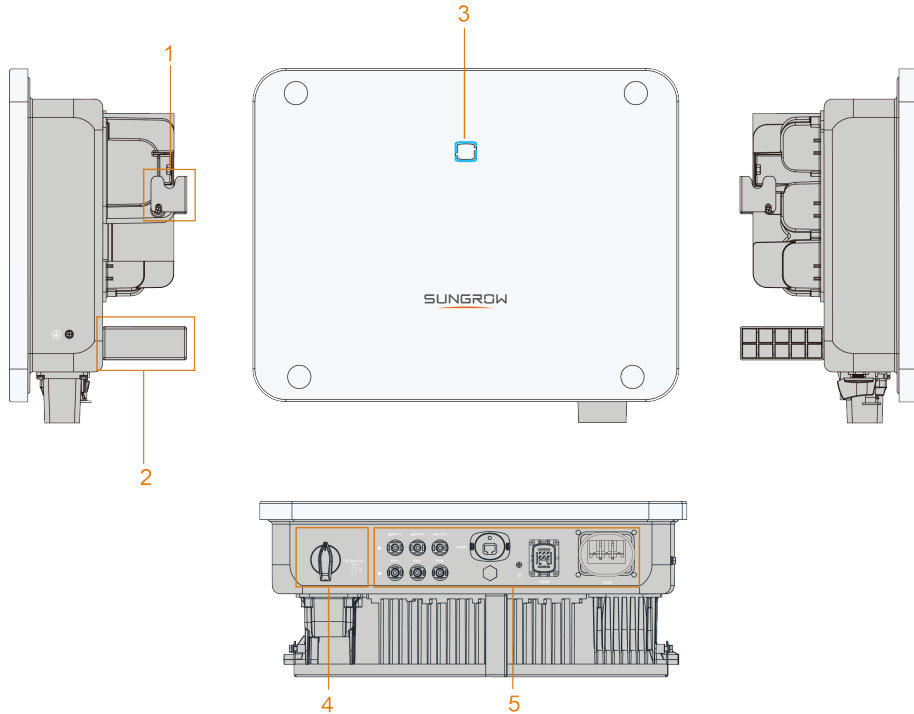

Figure 2-2 Inverter Appearance

No.	Name	Description
1	Hanger	Complement to the included wall mounting bracket for hanging the inverter.
2	Anti-tilt bracket	(Optional) To prevent the inverter from tilting when mounted with the mounting bracket.
3	LED panel	The LED indicator indicates the working state of the inverter.
4	DC switch	To safely disconnect the DC circuit whenever necessary.
5	Electrical connection area	DC terminals, AC terminal, external grounding terminal and communication terminals.

Dimensions

The following figure shows the dimensions of the inverter.

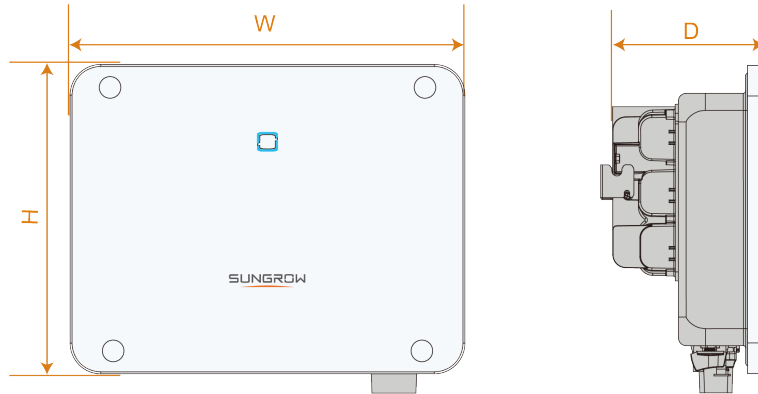



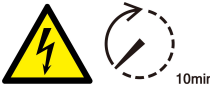



Figure 2-3 Dimensions of the Inverter

Inverter Model	W (mm)	H (mm)	D (mm)
SG7.5RS-L2, SG8.0RS-L2, SG10RS-L2	509	398	197

2.3 Symbols on Product

Symbol	Explanation
	Parameters on the DC side.
	Parameters on the AC on-grid side.
	Regulatory compliance mark.
	CE mark of conformity. EU/EEA Importer.
	Do not dispose of the inverter together with household waste.
	The inverter does not have a transformer.
	Disconnect the inverter from all the external power sources before maintenance!



Symbol	Explanation
	Read the user manual before maintenance!
	Burn danger due to the hot surface that may exceed 60°C.
	Danger to life due to high voltages! Only qualified personnel can open and service the inverter.
	Danger to life due to high voltages! Do not touch live parts for 10 minutes after disconnection from the power sources.
	External protective grounding terminal.



- The table shown here is for reference only. The actual product received may differ.
- Users may also attach other warning signs as per the requirements of the local standards or installation specifications.

2.4 LED Panel

The LED indicator on the front of the inverter indicates the working state of the inverter.

Table 2-1 State description of the LED indicator

LED color	State	Definition
 Blue	On	No system fault occurs. The inverter is in grid-connected operation (including operation with warnings).
	Slow gradient flashing (Period: 2s) 	No system fault occurs. The inverter is at standby or startup state (not feeding power into the grid). Manually shut down.
	Flashing	Low PV power.
 Red	On	A system fault has occurred (The inverter is unable to connect to the grid and feed power).

LED color	State	Definition
Red		A system warning is present (the inverter can still connect to the grid).
	On	The system is being upgraded.
Purple		
	Off	Both the AC and DC sides are powered off, and the DC bus voltage has discharged (with AC auxiliary power available). The DC side are powered off, and the DC bus voltage has discharged (AC input absent).
Gray		

WARNING

Voltage may still be present in AC side circuits after the indicator is off. Pay attention to the electricity safety during operating.

2.5 Circuit Diagram

The following figure shows the main circuit of the inverter.

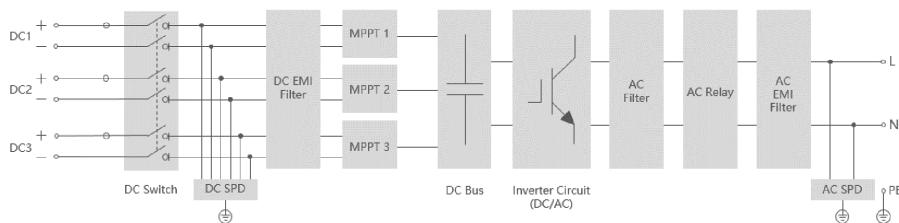

Figure 2-4 Circuit Diagram (SG10RS-L2 for example)

- DC Switches can safely disconnect the PV input when necessary to ensure the safe operation of the inverter and the safety of personnel.
- The DC SPD provides a discharge circuit for the DC side overvoltage to prevent it from damaging the internal circuits of the inverter.
- EMI filters can filter out the electromagnetic interference inside the inverter to ensure that the inverter meets the requirements of electromagnetic compatibility standards.
- The MPPT is used to ensure a maximum power from PV arrays at different PV input conditions.

- The Inverter Circuit converts the DC power into grid-compliant AC power and feeds it into the grid.
- The AC filter filters the output AC component of high frequency to ensure that the output current meets the grid requirements.
- The AC relay isolates the AC output of the inverter from the grid, making the inverter safe from the grid in case of inverter failure or grid failure.
- The AC SPD provides a discharge circuit for the AC side overvoltage to prevent it from damaging the internal circuits of the inverter.

DANGER

If the lightning level exceeds the protection level of the product, surge protection and overvoltage protection may fail, resulting in electric shock and fatal injury!

2.6 Function Description

Basic Function

- Conversion function
The inverter converts the DC power from the PV array to the AC power, in conformity with the grid requirements.
- Data storage
The inverter logs running information, error records, etc.
- Parameter configuration
The inverter provides various parameter configurations for optimal operation. Parameters can be set via the iSolarCloud App or the cloud server.
- Communication interface
The inverter is equipped with two communication interfaces. The communication device can be connected to the inverter via both interfaces.
After communication connection is established, users can view inverter information, operational data and can set inverter parameters through the iSolarCloud.



It is recommended to use the communication module from SUNGROW. Using a device from other companies may lead to communication failure or other unexpected damage.

- Protection Function
Several protective functions are integrated in the inverter, including short circuit protection, grounding insulation resistance monitoring, residual current protection, grid monitoring, DC overvoltage/overcurrent protection, etc.

Feed-in Limitation

Set the feed-in limitation value via iSolarCloud App. When the smart energy meter detects that the export power is greater than the limit value, the inverter will reduce the output power within the specified range.

PID Zero

The PID Zero function is applicable for both PV and DC-coupled PV plus storage systems. It can suppress PID during the day, by relieving or alleviating PV array voltage bias to PV-.

The traditional inverter needs boost circuit to extend the efficient generation time during the day, and break the symmetry of the PV array to the ground voltage, making it closer to the negative electrode. In addition, if the traditional inverter runs at night, the PV array to ground voltage is always limited to the lowest voltage point of the system, which increases the risk of PID.

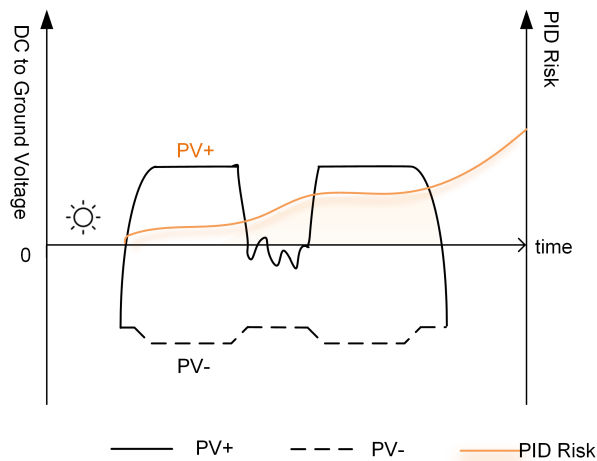

Figure 2-5 PID Risk of Traditional Inverters

The following figure is the PID risk of the inverter equipped with PID Zero, it prevents the PV array voltage from approaching PV-, reduces the risk of PID during daily operation. Details can be found in the *PID Zero White Paper*, which can be obtained on www.sungrowpower.com or from your distributor.

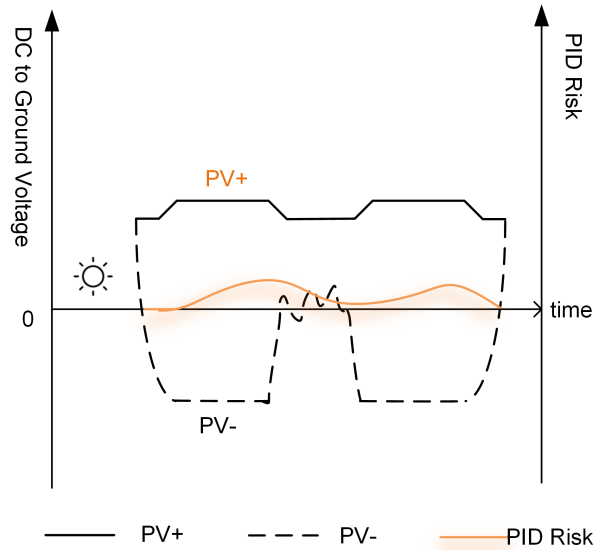

Figure 2-6 PID Risk of Inverters Equipped with PID Zero

⚠ DANGER

Keep the DC switch "ON" in the PID Zero process. During the process, there is voltage hazard between inverter / PV panels live conductors and ground. Do not touch any of them.



- When the PID Zero function is enabled, there will be a power consumption of less than 30 W in the PID Zero process.

AFCI Function (Optional)

- **AFCI activation**
This function can be enabled to detect whether serial fault arc occurs in the loop between PV array and inverter.
- **AFCI self-test**
This function is intended to test whether AFCI works as normal.
- **Clear AFCI Alarm**
When the inverter detects the AFCI alarm, it stops working. Clear the AFCI alarm so that the inverter can restart the detection.
- **Protection Coverage**
Two types of classifications are defined for AFCI protection, "F (Full coverage)" and "P (Partial coverage)". Full coverage protection ("F") is available for this inverter.
- **AFPE**
This inverter is equipped with a fully integrated AFPE, which is implemented within the inverter connected to the PV array and makes use of the enclosure and terminals of the inverter.
- **Method of Implementation**

Two implementation options are available for AFCI protection, “D” and “I”. “D” represents “Distributed detection system”, where the AFPE comprises more than one device. The devices may be standalone devices or partially integrated within the power conversion equipment (PCE). While “I” represents “PCE integrated device”, where the AFPE is implemented within a PCE connected to the PV array and makes use of the enclosure and terminals of the PCE. “I” is adopted for this inverter.

- Reconnection Method

Three reconnection methods are available for this inverter:

1. Manual reconnection

Reconnection can only be performed manually after arc interruption. You can log in via local access to the iSolarCloud App, and choose **More**→ **Settings**→ **Operation Parameters**→ **AFCI Parameters**→ **Clear AFCI Alarm**; after clearing the fault alarm, restart the device.

2. Remote manual reconnection

Reconnection can be performed via remote access to the AFPE after interruption. You can log in to iSolarCloud remotely. Then, find the target plant and choose **Settings**; select the device, and choose **Advanced Settings**→ **Power Control**→ **Clear AFCI Alarm**. After clearing the fault alarm, restart the device.

3. Automatic reconnection

Reconnection can be performed automatically after arc interruption.

Rule: Upon detecting a real arc fault, the device will report a fault and shut down. Within the day, for the 1st to 4th arc fault alarm, the device will shut down for 10 minutes, then the alarm will be cleared and the device will restart; when the 5th or more arc fault is reported, the device will shut down and not resume operation on that day.

In the event of the 1st to 4th arc fault alarm, ARM is powered off and restarted, and the device can restart and reconnect to the grid normally, with the fault count reset to "0". When the 5th arc fault is detected, if ARM is powered off and restarted due to external environment factors, the device will report a fault and shut down, with the fault count changing to "1"; after 10 minutes, the fault alarm will be cleared and the device will restart. If ARM is not powered off when the 5th or more arc fault is reported, you need to clear the fault manually to get the device restarted and reconnected to the grid normally; in this case, the fault count will be reset to "0". Or you can wait for the fault to be cleared automatically the next day, in which case the fault count will change to "1". See "Manual reconnection" and "Remote manual reconnection" for instructions on how to clear the fault alarm manually.

- AFCI protection configuration.

The AFCI configuration of each inverter model is shown in the table below.

Model	SG7.5/8.0/10RS-L2
Classification	F-I-AFPE-1-1/1/1-3
Number of monitored strings per input port	1

Model	SG7.5/8.0/10RS-L2
Number of input ports per channel	1
Number of monitored channels	3
Rated channel current	20A
Maximum current per input port	20A
Rated interruption current	20A

NOTICE

For SG8.0RS-L2 inverters, if two PV strings are connected to PV2, enable PV2 Branch Connector to activate arc fault detection for PV2; if only one string is connected to PV2, this is not required. To configure this setting, open iSolarCloud and choose Inverter > Settings > Operation Parameters > String Detection > PV2 Branch Connector.



The fault arc detection function meets the standard requirements, please test under the working conditions as required by the standard.

3 Unpacking and Storage

3.1 Unpacking and Inspection

The product is thoroughly tested and strictly inspected before delivery. Nonetheless, damage may still occur during shipping. For this reason, please conduct a thorough inspection after receiving the product.

- Check the packing case for any visible damage.
- Check the scope of delivery for completeness according to the packing list.
- Check the inner contents for damage after unpacking.

Contact SUNGROW or the transport company in case of any damage or incompleteness, and provide photos to facilitate services.

Do not dispose of the original packing case. It is recommended to store the device in the original packing case when the product is decommissioned.

NOTICE

- **After receiving the product, check whether the appearance and structural parts of the device are damaged, and check whether the packing list is consistent with the actual ordered product. If there are problems with the above inspection items, do not install the device and contact your distributor first. If the problem persists, contact SUNGROW in time.**
- **If any tool is used for unpacking, be careful not to damage the product.**

3.2 Inverter Storage

Proper storage is required if the inverter is not installed immediately.

- Store the inverter in the original packing case with the desiccant inside.
- The storage temperature must be always between -30°C and $+70^{\circ}\text{C}$, and the storage relative humidity must be always between 0 and 95 %, non-condensing.
- In case of stacking storage, the number of stacking layers should never exceed the limit marked on the outer side of the packing case.
- The packing case should be upright.
- If the inverter needs to be transported again, pack it strictly before loading and transporting it.

- Do not store the inverter in places susceptible to direct sunlight, rain, and strong electric field.
- Do not place the inverter in places with items that may affect or damage the inverter.
- Store the inverter in a clean and dry place to prevent dust and water vapor from eroding.
- Do not store the inverter in places with corrosive substances or susceptible to rodents and insects.
- Carry out periodic inspections. Inspection shall be conducted at least once every six months. If any insect or rodent bites are found, replace the packaging materials in time.
- If the inverter has been stored for one year or longer, or has been mounted but remains non-operational for more than three months, it must be inspected and tested by qualified personnel before being put into operation.

NOTICE

Please store the inverter according to the storage requirements. Product damage caused by failure to meet the storage requirements is not covered by the warranty.

4 Mechanical Mounting

WARNING

Respect all local standards and requirements during mechanical installation.

4.1 Safety During Mounting

DANGER

Make sure there is no electrical connection before installation.
Before drilling, avoid the water and electricity wiring in the wall.

WARNING

For specific requirements for the installation environment, see [4.2.1 Installation Environment Requirements](#). In case the environment where the product is installed does not meet the requirements, SUNGROW shall not be held liable for any property damage arising therefrom.

CAUTION

Improper handling may cause personal injury!

- When moving the product, be aware of its weight and keep the balance to prevent it from tilting or falling.
- Wear proper protective equipment before performing operations on the product.
- The bottom terminals and interfaces of the product cannot directly contact the ground or other supports. The product cannot be directly placed on the ground.

NOTICE

During installation, ensure that no device in the system causes it hard for the DC switch and the AC circuit breaker to act or hinders maintenance personnel from operating.

If drilling is required during installation:

- Wear goggles and protective gloves when drilling holes.
- Make sure to avoid the water and electricity wiring in the wall before drilling.
- Protect the product from shavings and dust.

4.2 Location Requirements

To a large extent, a proper installation location ensures safe operation, service life, and performance of the inverter.

- The inverter with protection rating IP65 can be installed both indoors and outdoors.
- The inverter should be installed at a height that allows easy viewing of the LED indicator panel, as well as easy electrical connection, operation and maintenance.

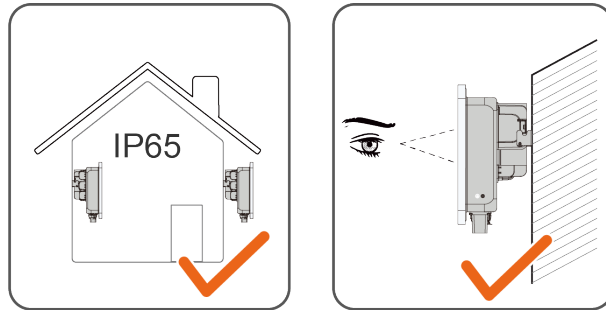

4.2.1 Installation Environment Requirements

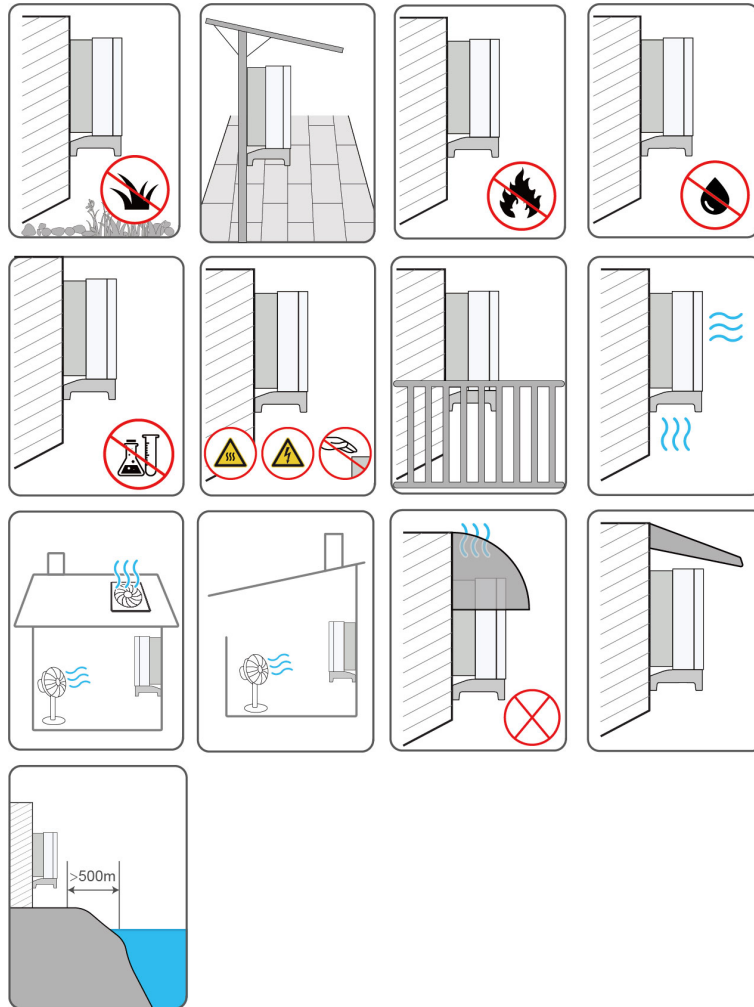

- If the inverter is installed in a place with lush vegetation, weed on a regular basis. In addition, the ground beneath the inverter needs to undergo certain treatment, such as laying cement or gravel, etc. (an area of 3 m × 2.5 m is recommended).
- Do not install the inverter in an environment with flammables, explosives, or smoke.
- Do not install the inverter in places prone to water leak, e.g., under the air-conditioner vent, the air vent, or the cable outlet window of the machine room, so as to prevent device damage or short circuit caused by intrusion of water.
- Do not install the inverter in a place with corrosives such as corrosive gas and organic solvent, etc.
- When the inverter is running, its surface may carry high voltages or get very hot. Do not touch it; otherwise, it may lead to burns or electric shocks.
- Do not install the inverter in a place that can be easily reached.
- The installation site must have solid ground, free of rubber-like soils (which cannot be effectively compacted) or weak soils, and should not be prone to subsidence. Also,

avoid low-lying areas where water or snow may accumulate. Ensure the site is located above the highest recorded water level in the area.

- Do not install the inverter in a position that could be flooded.
- To prevent vegetation or water on the ground from impacting inverter operation, if the space above meets the designated requirements, elevate the inverter to an appropriate height.
- Good heat dissipation is very important to the inverter. Please install the inverter in a ventilated environment.
- Please consult SUNGROW before installing inverters outdoors in areas prone to salt damage, which are mainly coastal areas within 500 meters of the coast. The sedimentation amount of salt spray is correlated to the characteristics of the seawater, sea winds, precipitation, air humidity, topography, and forest coverage in the adjacent sea areas, and there are substantial differences between different coastal areas.
- To ensure device safety and service life, avoid using this product in highly polluted environments containing substances such as sulfur or halogens.
- The inverter is strictly prohibited from being installed in environments with vibration or strong electromagnetic fields (including strong common-mode interference). A strong magnetic field environment refers to one where the magnetic field strength exceeds 30 A/m. The aforementioned environments may cause the product to malfunction.
- In dusty environments such as places full of dust, smoke, or floc, particles may cling to the device's air outlet or heat sink, thus impacting its heat dissipation performance or even getting it damaged. Therefore, do not install the inverter in dusty environments. If the inverter has to be installed in such environments, please clean its fans and heat sink on a regular basis to ensure a good heat dissipation performance.
- To avoid disturbing residents in living areas with noise generated during the operation of the device, do not install the inverter in noise-sensitive areas such as bedrooms. It is preferable to choose an open location that is far away from the living and resting areas.
- The average temperature approximately 1 m around the inverter should be taken as its ambient operating temperature. The temperature and humidity should meet the requirements below:

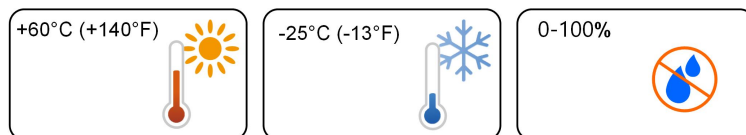

4.2.2 Carrier Requirements

The mounting structure where the inverter is installed must comply with local/national standards and guidelines. Ensure that the installation surface is solid enough to bear four times the weight of the inverter and is suitable for the dimensions of the inverter (e.g. cement walls, plasterboard walls, etc.).

Do not install the inverter on a carrier that may vibrate in resonance, so as to avoid making bigger noise.

Installation on combustible building materials is strictly prohibited. Suitable mounting surfaces include:

Non-combustible wall surfaces: Concrete, fire-resistant gypsum board, brick wall, etc. Non-combustible roof structures: Color-Coated corrugated steel roofing sheets, precast concrete slabs, fiber-reinforced cement boards, etc.

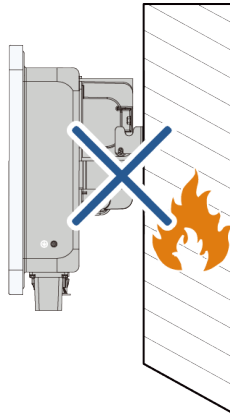

4.2.3 Angle Requirements

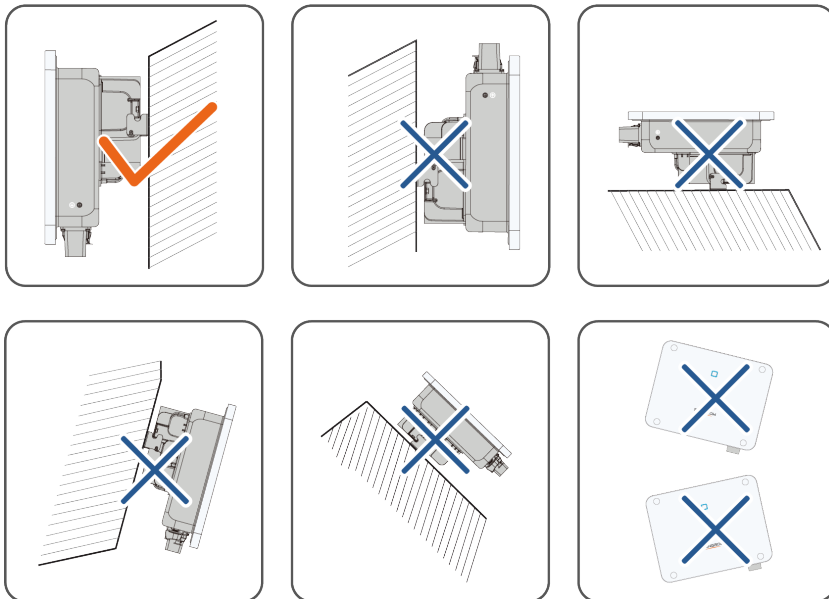

4.2.4 Clearance Requirements

Reserve enough clearance around the inverter to ensure sufficient space for heat dissipation.

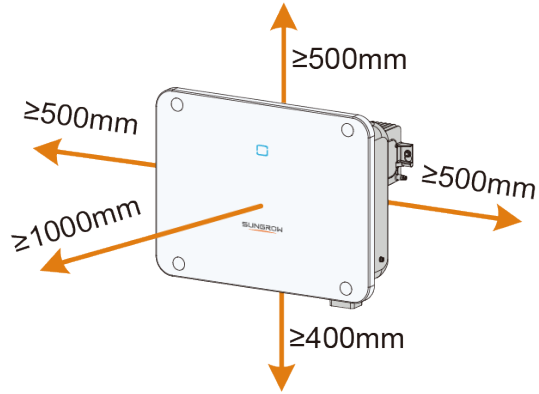

In case of multiple inverters, reserve specific clearance between the inverters.

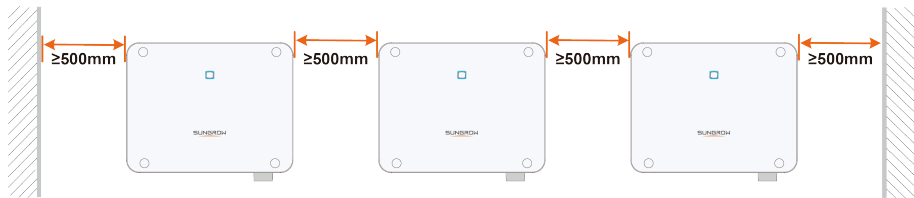

4.3 Tools and Instruments

Installation tools include but are not limited to the following recommended ones. If necessary, use other auxiliary tools on site.

 The tools listed in the manual are suitable for both installation and disassembly.

Table 4-1 Installation Tools

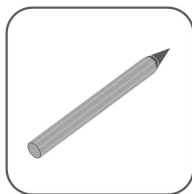

Marker

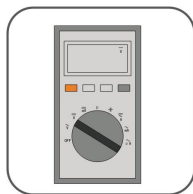

Multimeter (≥ 600 Vdc)

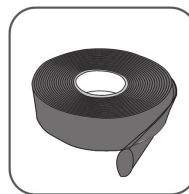

Heat shrink tubing

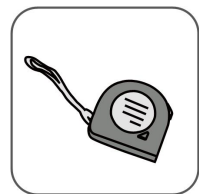

Measuring tape

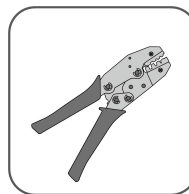
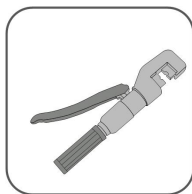











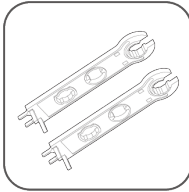

<p>Hydraulic pliers</p> 	<p>Crimping tool</p> 	<p>Crimping tool</p> 	<p>Phillips screwdriver (M4, M5, M6)</p> 
<p>Electric screwdriver (M4, M5, M6)</p> 	<p>Wrench for MC4 terminal</p> 	<p>Wire stripper</p> 	<p>Hammer drill (φ10)</p> 
<p>Heat gun</p> 	<p>Open-end wrench (10 mm, 24 mm, 42 mm)</p> 	<p>Rubber mallet</p> 	<p>Allen wrench (H4)</p> 
<p>Vacuum cleaner</p> 			

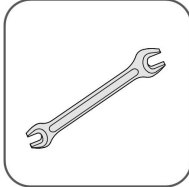
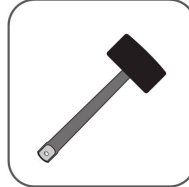
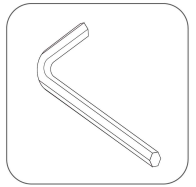
Table 4-2 Personal Protective Equipment

			
<p>Goggles</p>	<p>Earplugs</p>	<p>Dust mask</p>	<p>Safety gloves</p>

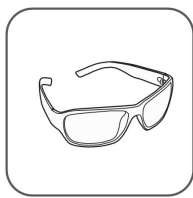
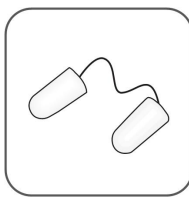
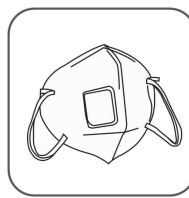

Safety shoes

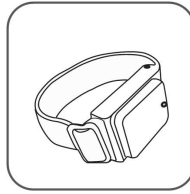
Anti-static wrist
strap

4.4 Moving the Inverter

Before installation, remove the inverter from the packing case and move it to the installation site. Follow the instructions below as you move the inverter:

- Always be aware of the weight of the inverter.
- Lift the inverter using the handles positioned on both sides of the inverter.
- Move the inverter by one or two people or by using a proper transport tool.
- Do not release the equipment unless it has been firmly secured.

⚠ CAUTION

Improper handling may cause personal injury!

- **Arrange an appropriate number of personnel to carry the inverter according to its weight, and installation personnel should wear protective equipment such as anti-impact shoes and gloves.**
- **Attention must be paid to the center of gravity of the inverter to avoid tilting during handling.**
- **Placing the inverter directly on a hard ground may cause damage to its metal enclosure. Protective materials such as sponge pad or foam cushion should be placed underneath the inverter.**
- **Move the inverter by holding the handles on it. Do not move the inverter by holding the terminals.**

4.5 Installing the Inverter

Inverter is installed on the wall by means of wall-mounting bracket and the expansion plug sets.

The expansion plug set shown below is recommended for the installation.

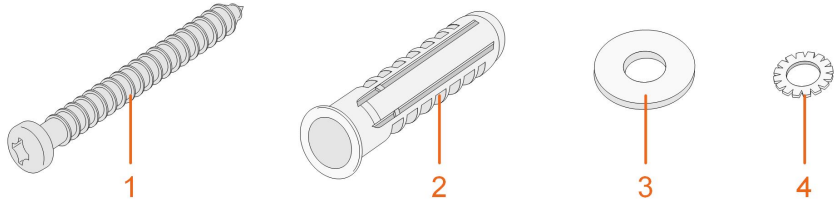

(1) Self-tapping screw M6

(2) Expansion tube

(3) Fender washer

(4) Spring washer

Step 1 Place the wall-mounting bracket to a proper position on the wall. Mark the positions and drill the holes.

NOTICE

Observe the level on the bracket and adjust until the bubble is in the middle position.
The depth of the holes should be about 70 mm.

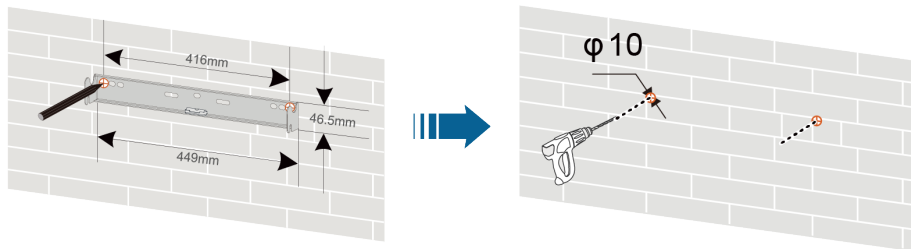

Step 2 Place the expansion tubes into the holes. Then secure the wall-mounting bracket to the wall firmly with the expansion bolt sets.

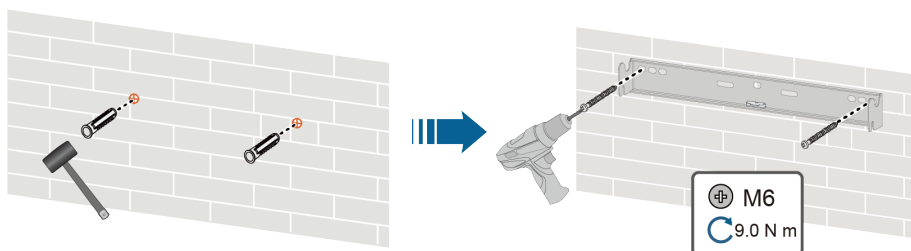

Step 3 (Optional) Install the anti-tilt bracket onto the inverter.

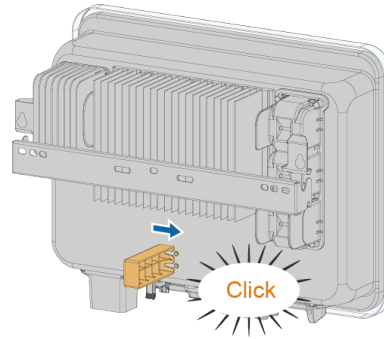

Step 4 Lift the inverter and slide it down along the wall-mounting bracket to make sure they match perfectly. Use two screw sets to lock both left and right sides.

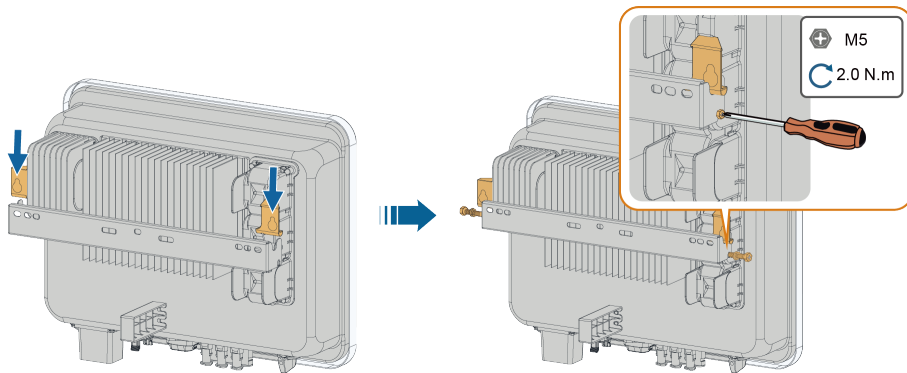

--End

5 Electrical Connection

5.1 Safety Instructions

DANGER

The PV string will generate lethal high voltage when exposed to sunlight.

- Operators must wear proper personal protective equipment during electrical connections.
- Must ensure that cables are voltage-free with a measuring instrument before touching DC cables.
- Respect all safety instructions listed in relevant documents about PV strings.

DANGER

- Before electrical connections, please make sure that the inverter switch and all switches connected to the inverter are set to "OFF", otherwise electric shock may occur!
- Ensure that the inverter is undamaged and all cables are voltage free before performing electrical work.
- Do not close the AC circuit breaker until the electrical connection is completed.

WARNING

Do not damage the ground conductor. Do not operate the product in the absence of a properly installed ground conductor. Otherwise, it may cause personal injury or product damage.

Please use measuring devices with an appropriate range. Overvoltage can damage the measuring device and cause personal injury.

Damage to the product caused by incorrect wiring is not covered by the warranty.

- Electrical connection must be performed by professionals.
- Operators must wear proper personal protective equipment during electrical connections.
- All cables used in the PV generation system must be firmly attached, properly insulated, and adequately dimensioned. Cables used shall comply with the requirements of local laws and regulations.
- The factors that affect cable selection include rated current, cable type, routing mode, ambient temperature, and maximum expected line loss.

NOTICE

All electrical connections must comply with local and national/regional electrical standards.

- **Cables used by the user shall comply with the requirements of local laws and regulations.**
- **Only with the permission of the national/regional grid department, the inverter can be connected to the grid.**
- **Requires external protection device.**
- **Requires external multipole interruption device for current carrying wires disconnection.**
- **Requires an external residual current device (DR), suitable for protection against electric shock, in accordance with the ABNT NBR 5410 standard.**
- **It is expressly recommended to use rapid shutdown methods, systems or devices on the d.c.circuit. that guarantee safety in firefighting situations.**
- **The installation of this equipment must comply with current technical standards for photovoltaic electrical installation (NBR 16690) and fire risk management in photovoltaic systems (IEC 63226).**
- **This equipment is compatible with external independent rapid shutdown devices.**

NOTICE

- **Install the external protective grounding cable first when performing electrical connection and remove the external protective grounding cable last when removing the inverter.**
- **Keep the AC output cable and the DC input cable close to each other during electrical connection.**
- **Comply with the safety instructions related to PV strings and the regulations related to the utility grid.**

NOTICE

- After being crimped, the OT terminal must wrap the wires completely, and the wires must contact the OT terminal closely.
- When using a heat gun, protect the device from being scorched.
- Keep the PV+ cable and PV- cable close to each other when connecting DC input cables.
- Before connecting a power cable (such as the AC cable, the DC cable, etc.), confirm that the label and identifier on the power cable are correct.
- When laying out communication cables, separate them from power cables and keep them away from strong interference sources to prevent communication interruption.
- All vacant terminals must be covered with waterproof covers to prevent affecting the protection performance.
- Ensure that AC output cables are firmly connected. Failing to do so may cause inverter malfunction or damage to its AC connectors.
- When the wiring is completed, seal the gap at the cable inlet and outlet holes with fireproof/waterproof materials such as fireproof mud to prevent foreign matter or moisture from entering and affecting the long-term normal operation of the inverter.



The cable colors in figures in this manual are for reference only. Please select cables according to local cable standards.

5.2 Terminal Description

Most electrical terminals are located at the bottom of the inverter.

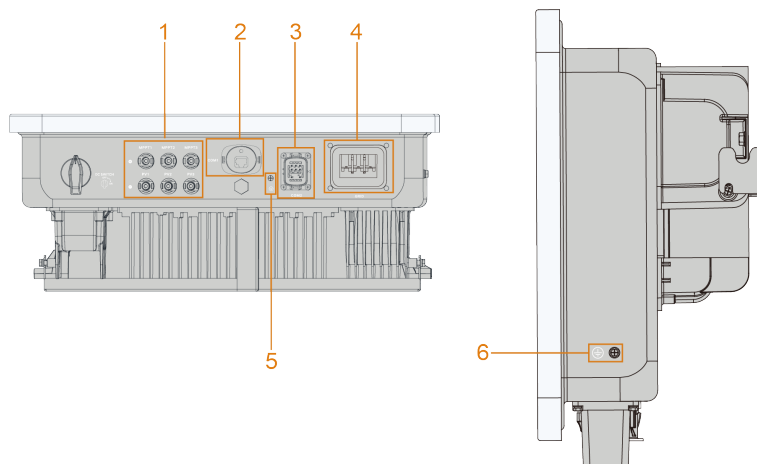



Figure 5-1 Terminals (SG10RS-L2 for example)

* The image shown here is for reference only. The actual product received may differ.

Table 5-1 Terminal Description

No.	Name	Description	Decisive Voltage Classification
1	PV1+, PV1-, PV2+, PV2-, PV3+, PV3-	MC4 terminals for PV input. The terminal number depends on inverter model.	DVC-C
2	COM1	Communication accessory port to be connected to WiFi-P2/EyeS4 communication module.	DVC-A
3	COM2	Communication connection for RS485, CT	DVC-A
4	GRID	AC terminal to connect to the grid.	DVC-C
5, 6		External grounding terminal.	Not applicable

The pin definition of COM2 terminal is shown in the following label.

RS485-1	CT	
1	3	5
A	CT+	
2	4	6
B	CT-	
7		8
PE		PE

Figure 5-2 Label of COM2 Terminal

Table 5-2 Label Description of COM2 Terminal

Label	Description
1, 2	For connecting smart meters, external loggers, or for inveter daisy-chaining.
7, 8	For connecting the shielding layer of the RS485 cable.
3, 4	For grid feed-in current sampling.

5.3 Electrical Connection Overview

The electrical connection should be realized as follows:

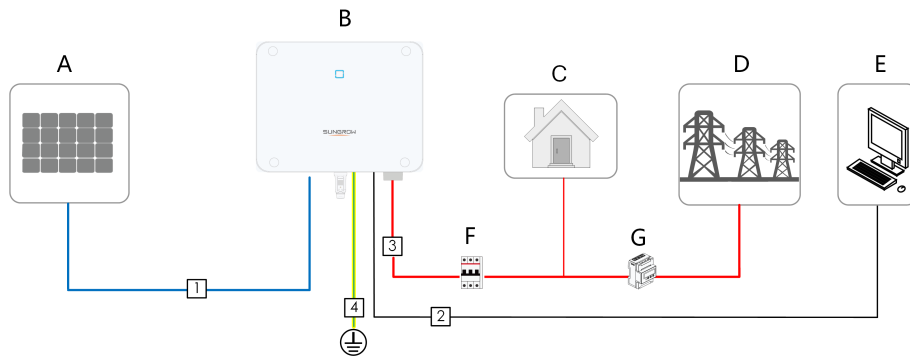

(A) PV string

(B) Inverter

(C) Loads

(D) Grid

(E) External device

(F) AC circuit breaker

(G) Meter

Table 5-3 Cable Requirements

No.	Cable	Type	Cable Diameter	Cross-section
1	DC cable	Outdoor multi-core copper wire cable complying with 600 V and 20 A standard	4.7 mm~6.4 mm	4 mm ² ~6 mm ²
2	RS485 cable (1)	Shielded twisted pair	4.8 mm~6.5 mm	2 * 0.5 mm ²
3	AC cable (1)(2)	Outdoor one 3-core copper wire cable	16 mm~22 mm 18 mm~25mm	10 mm ² ~16 mm ²
		Outdoor three single-core copper wire cables	6.3 mm~7.5 mm 7.5 mm~9.4 mm	10 mm ² ~16 mm ²
4	External Grounding cable	Outdoor single-core copper wire cable	4 mm~10 mm	The same as that of the PE wire in the AC cable

(1) All the AC wires should be equipped with correctly colored cables for distinguishing. Please refer to related standards about the wiring color.

- (2) Select appropriate OT terminals based on the diameter of the AC cable.

5.4 External Protective Grounding Connection

DANGER

- There are large currents during the inverter's operation. If the inverter is powered on and put into operation without being grounded, it may lead to electric shock hazards or failures of major protective functions such as surge protection. Therefore, before powering on the inverter, make sure it has been reliably grounded; otherwise, damages caused therefrom will not be covered by warranty.
- When performing electrical connections of the inverter, give the highest priority to grounding. Be sure to carry out the grounding connection first.

WARNING

- Since the inverter is not equipped with a transformer, neither the negative electrode nor the positive electrode of the PV string can be grounded. Otherwise, the inverter will not operate normally.
- Connect the grounding terminal to the external protective grounding point before AC cable connection, PV string connection, and communication cable connection.
- The external protective grounding point provides a reliable ground connection. Do not use an improper grounding conductor for grounding, Otherwise, it may cause product damage or personal injury.
- Depending on Local Rules, please also ground the PV panel subconstruction to the same common grounding point (PE Bar) in addition to local lightning protection rules.

⚠ WARNING

The external protective grounding terminal must meet at least one of the following requirements.

- The cross-sectional area of the grounding cable is not less than 10 mm² for copper wire or 16 mm² for aluminum wire. It is recommended that both the external protective grounding terminal and the AC side grounding terminal be reliably grounded.
- If the cross-sectional area of the grounding cable is less than 10 mm² for copper wire or 16 mm² for aluminum wire, ensure that both the external protective grounding terminal and the AC side grounding terminal are reliably grounded.

The grounding connection can be made by other means if they are in accordance with the local standards and regulations, and SUNGROW shall not be held liable for the possible consequences.

5.4.1 External Protective Grounding Requirements

All non-current carrying metal parts and device enclosures in the PV power system should be grounded, for example, brackets of PV modules and inverter enclosure.

When there is only one inverter in the PV system, connect the external protective grounding cable to a nearby grounding point.

When there are multiple inverters in the PV system, connect the external protective grounding terminals of all inverters and the grounding points of the PV module brackets to ensure equipotential connections to ground cables (according to the onsite conditions).

5.4.2 Connection Procedure

External grounding cable and OT/DT terminal are prepared by customers.

Step 1 Prepare the cable and OT/DT terminal.

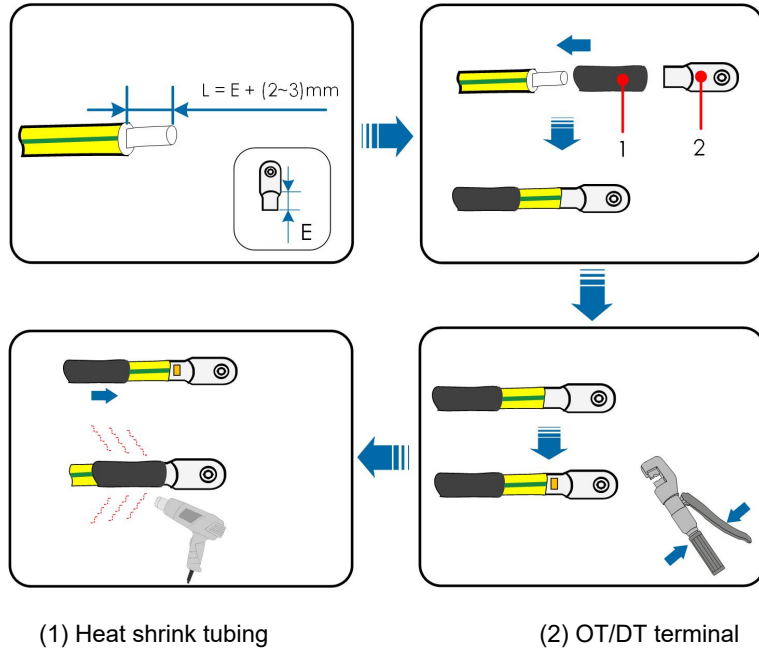

i After being crimped, the OT terminal must wrap the wires completely, and the wires must contact the OT terminal closely. When using a heat gun, protect the device from being scorched.

Step 2 Remove the screw on the grounding terminal and fasten the cable with a screwdriver.

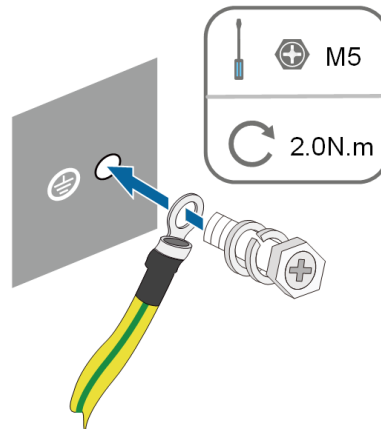

Step 3 Apply paint to the grounding terminal to ensure corrosion resistance.

--End

5.5 AC Cable Connection

5.5.1 AC Side Requirements



Only with the permission of the local grid department, the inverter can be connected to the grid.

Before connecting the inverter to the grid, ensure the grid voltage and frequency comply with requirements, for which, refer to "**Technical Data**". Otherwise, contact the electric power company for help.

AC Circuit Breaker

An independent two-pole circuit breaker must be installed on the output side of the inverter to ensure safe disconnection from the grid. The recommended specifications are as follows.

Inverter Model	Recommended Specification
SG7.5RS-L2/SG8.0RS-L2	50A
SG10RS-L2	63A

⚠ WARNING

AC circuit breakers should be installed on the output side of the inverter and the grid side to ensure safe disconnection from the grid.

- **Determine whether an AC circuit breaker with greater overcurrent capacity is required based on actual conditions.**
- **Do not connect any local load between the inverter and the AC circuit breaker.**
- **Multiple inverters cannot share one AC circuit breaker.**

Residual Current Monitoring Device

With an integrated universal current-sensitive residual current monitoring unit included, the inverter will disconnect immediately from the mains power once a fault current with a value exceeding the limit is detected.

However if an external residual current device (RCD) (type B is recommended) is mandatory, the switch must be triggered at a residual current of 300 mA (recommended). RCD of other specifications can also be used according to local standard.

5.5.2 Connecting the AC Cable

Step 1 Disconnect the AC circuit breaker and secure it against reconnection.

Step 2 Remove the dust cover from the AC port of the inverter.

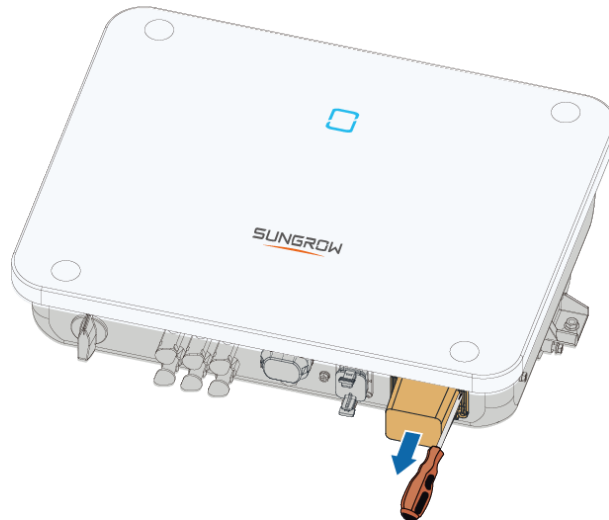

Step 3 Take out the AC waterproof cover, unscrew the swivel nut and take out the sealing ring. Thread the AC cable through the swivel nut, appropriate sealing and waterproof cover in sequence.

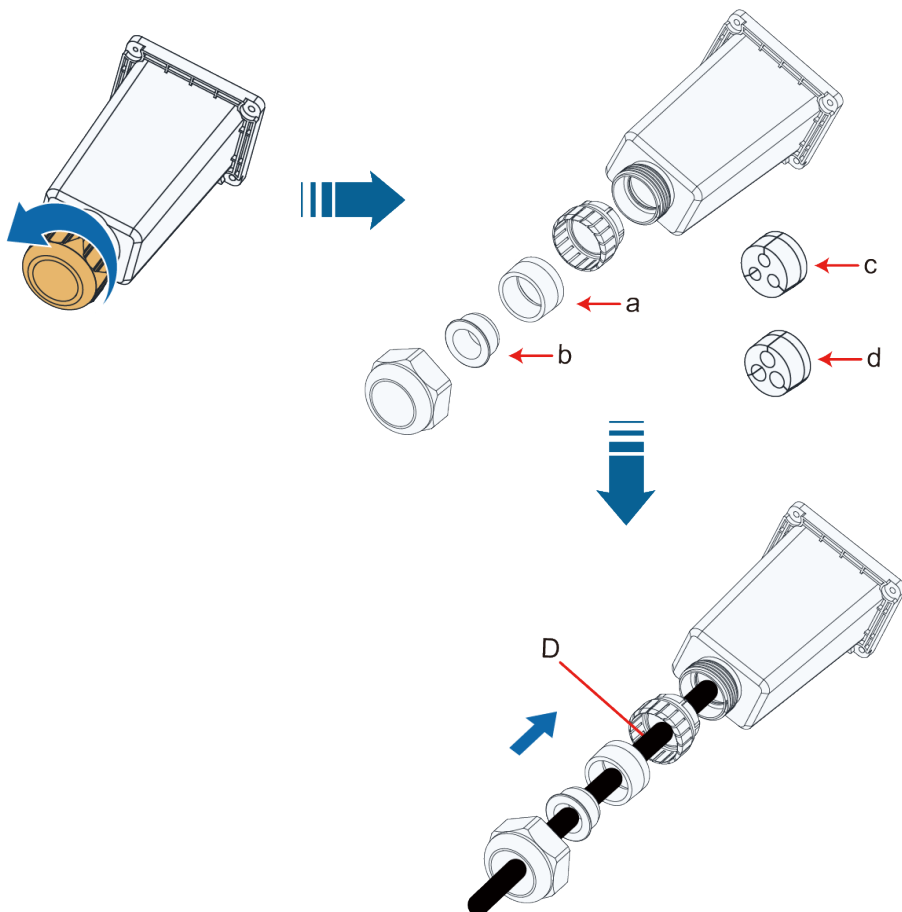

Cable diameter D(mm)	Sealing rings	Remarks
16~18	a+b	One three-core cable
18~25	a	One three-core cable
6.3~7.5(*3)	c	8AWG, 7AWG, three single-core cables
7.5~9.4(*3)	d	6AWG, 5AWG, three single-core cables

Step 4 Strip the cable jacket and the wire insulation as shown in the following figure.

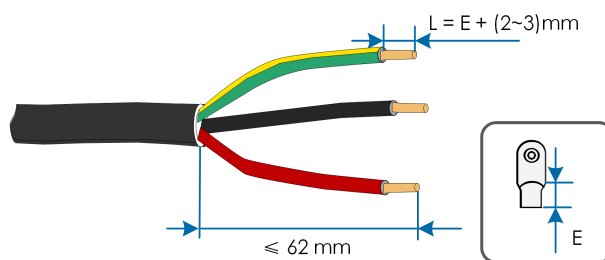

Step 5 Crimp the OT/DT terminal.

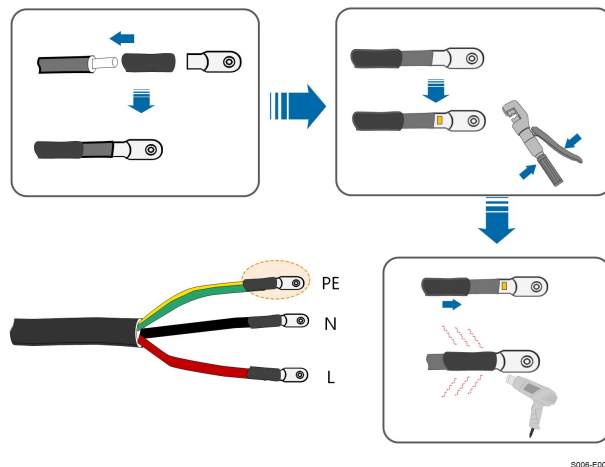

Step 6 Fix all the wires to the terminals according to the assignment and tighten to a torque of 2.0 N•m with a screwdriver.

NOTICE

Observe the terminal assignment. Do not connect any phase line to the "PE" terminal or PE wire to "N" terminal. Otherwise, unrecoverable damage to the inverter may follow.

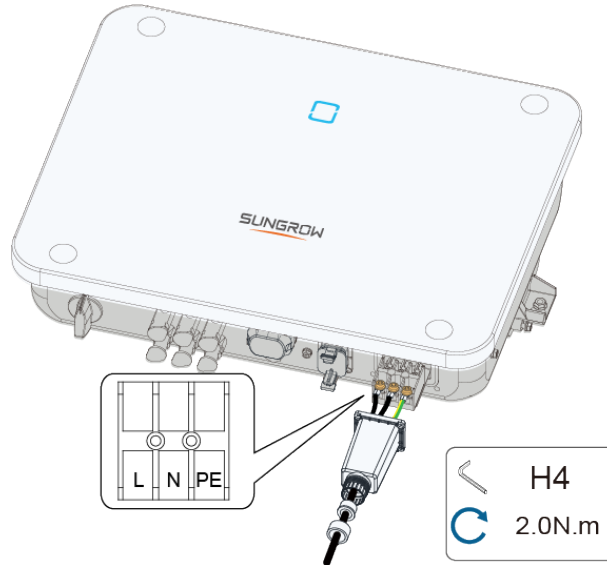

Step 7 Secure the AC waterproof cover to the inverter with a torque of 1.2 N·m and tighten the swivel nut to a torque of 7.5 N·m -11 N·m.

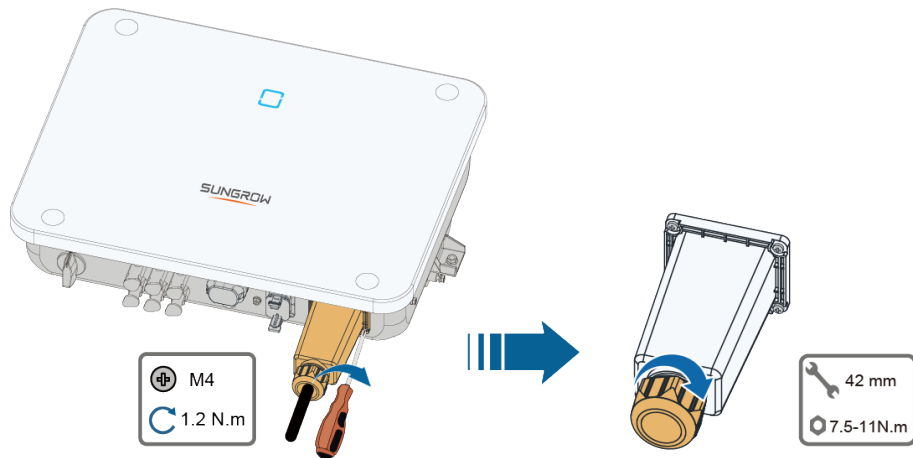

Step 8 Connect the PE wire to ground and the phase lines and the “N” line to AC circuit breaker. Then connect the AC circuit breaker to electric board.

Step 9 Make sure all wires are firmly installed via the right torque tool or dragging the cables slightly.

--End

5.6 DC Cable Connection

⚠ DANGER

The PV string will generate lethal high voltage when exposed to sunlight.

- Respect all safety instructions listed in relevant documents about PV strings.

⚠ WARNING

- **Make sure the PV array is well insulated to ground before connecting it to the inverter.**
- **Make sure the maximum DC voltage and the maximum short circuit current of any string never exceed inverter permitted values specified in "Technical Data".**
- **Check the positive and negative polarity of the PV strings, and connect the PV connectors to corresponding terminals only after ensuring polarity correctness.**
- **During the installation and operation of the inverter, please ensure that the positive or negative electrodes of PV strings do not short-circuit to the ground. Otherwise, an AC or DC short-circuit may occur, resulting in equipment damage. The damage caused by this is not covered by the warranty.**
- **Electric arc or contactor over-temperature may occur if the DC connectors are not firmly in place, and the loss caused is not covered by the warranty.**
- **If the DC input cables are reversely connected or the positive and negative terminals of different MPPT are shorted to ground at the same time, while the DC switch is in the "ON" position, do not operate immediately. Otherwise, the inverter may be damaged. Please turn the DC switch to "OFF" and remove the DC connector to adjust the polarity of the strings when the string current is lower than 0.5 A.**
- **Use the DC connectors supplied with the product for DC cable connection. Using incompatible DC connectors may result in serious consequences, and the device damage is not covered under warranty.**
- **Do not connect one PV string to multiple inverters. Otherwise, the inverters may be damaged.**

NOTICE

The following requirements about PV string connection must be met. Otherwise, it may cause irreversible damage to the inverter, which is not covered by the warranty.

- **Mixed use of PV modules of different brands or models in one MPPT circuit, or PV modules of different orientation or inclination in a string may not damage inverter, but will cause system bad performance!**
- **The inverter enters standby state when the input voltage ranges between 560 V and 600 V. The inverter returns to running state once the voltage returns to the MPPT operating voltage range, namely, 40 V to 560 V.**

NOTICE

Note the following items when laying cables on site:

- The axial tension on PV connectors must not exceed 80 N. Avoid axial cable stress on the connector for a long time during field wiring.
- Radial stress or torque must not be generated on PV connectors. It may cause the connector waterproof failure and reduce connector reliability.
- Leave at least 50 mm of slack to avoid the external force generated by the cable bending affecting the waterproof performance.
- Refer to the specifications provided by the cable manufacturer for the minimum cable bending radius. If the required bending radius is less than 50 mm, reserve a bending radius of 50 mm. If the required bending radius is greater than 50 mm, reserve the required minimum bending radius during wiring.

5.6.1 PV Input Configuration

- As shown in the figure below, the inverter is provided with multiple PV inputs, and each PV input is designed with an MPP tracker.
- The PV strings to the same DC input area should have the same type, the same number of PV panels, identical tilt and identical orientation for maximum power.
- The PV strings to two DC input areas may differ from each other, including PV module type, number of PV modules in each string, angle of tilt, and installation orientation.
- Three modes are available for PV input connection, namely, Independent mode, Parallel Connection mode, and Partial Parallel Connection mode. In Partial Parallel Connection mode, the parallel connection of PV1 and PV2 is supported.

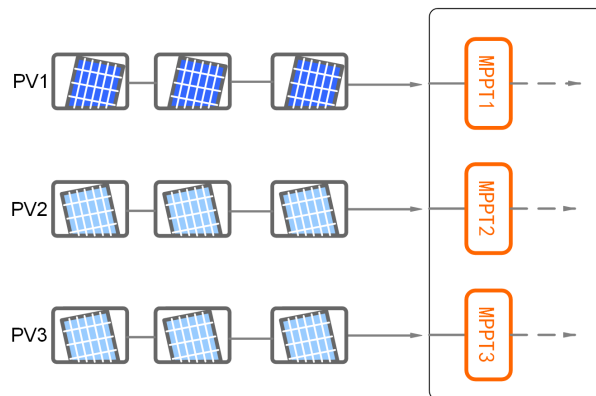

Figure 5-3 PV Input Configuration

Parallel Connection mode and Partial Parallel Connection mode are available for PV input connection. In Partial Parallel Connection mode, the parallel connection of PV1 and PV2 is supported.

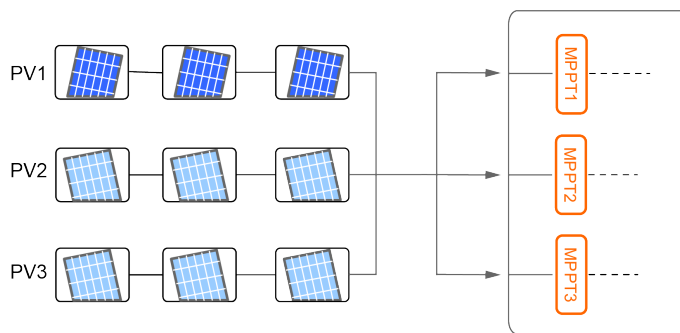

Figure 5-4 Parallel Connection

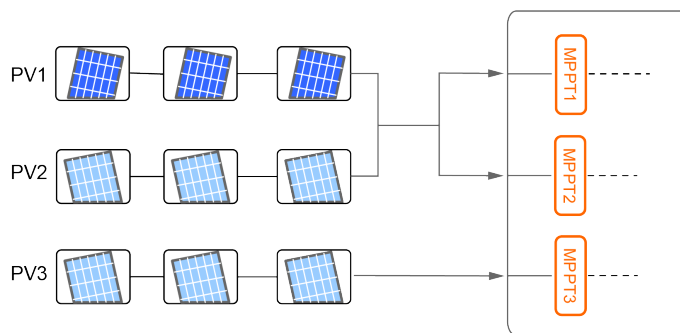

Figure 5-5 Partial Parallel Connection

Prior to connecting the inverter to PV inputs, the specifications in the following table should be met:

Inverter Model	Open-circuit Voltage Limit	Max. current for input connector
All models	600 V	20 A

5.6.2 Assembling the PV Connectors

⚠ DANGER

High voltage may be present in the inverter!

- Ensure all cables are voltage-free before performing electrical operations.
- Do not connect the DC switch and AC circuit breaker before finishing electrical connection.



To ensure IP65 protection, use only the supplied connector.

Step 1 Strip the insulation from each DC cable by 7 mm–8 mm.

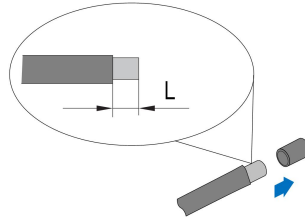

Step 2 Assemble the cable ends with the crimping pliers.

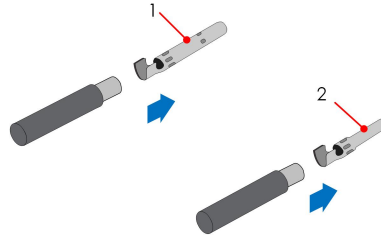

1: Positive crimp contact

2: Negative crimp contact

Step 3 Lead the cable through cable gland, and insert the crimp contact into the insulator until it snaps into place. Gently pull the cable backward to ensure firm connection. Tighten the cable gland and the insulator (torque 2.5 N.m to 3 N.m).

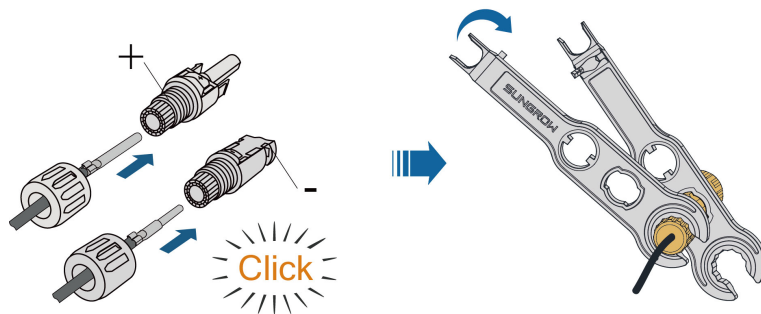

Step 4 Check for polarity correctness.

NOTICE

If the PV polarity is reversed, the inverter will be in a fault or alarm state and will not operate normally.

--End

5.6.3 Installing the PV Connectors

Step 1 Rotate the DC switch to "OFF" position.

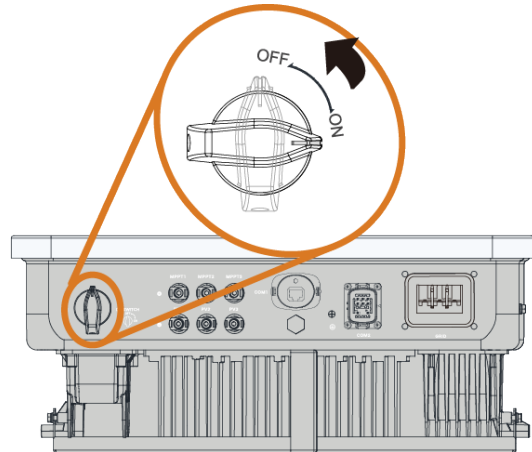

Step 2 Check the cable connection of the PV string for polarity correctness and ensure that the open circuit voltage in any case does not exceed the inverter input limit of 600 V.

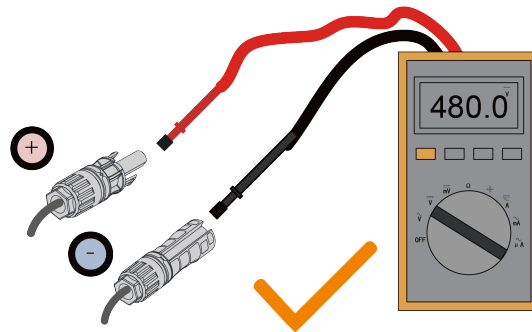

Step 3 Connect the PV connectors to corresponding terminals until there is an audible click.

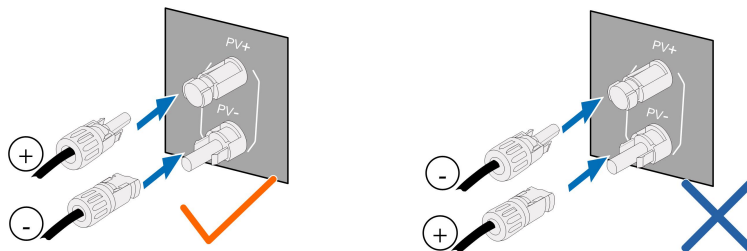

Step 4 Seal the unused PV terminals with the terminal caps.

--End

5.7 Wireless Communication Module Connection

Step 1 Remove the waterproof lid from the **COM1** terminal.

Step 2 Install the WiFi-P2/EyeS4 module. Slightly shake it by hand to determine whether it is installed firmly, as shown below.

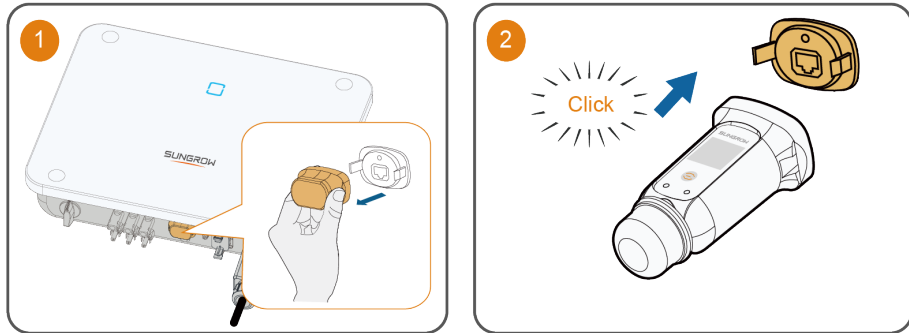

Step 3 Refer to the guide delivered with the module for the set-up.

--End

5.8 RS485 Connection

Step 1 Remove the dust cover from the COM2 port of the inverter.

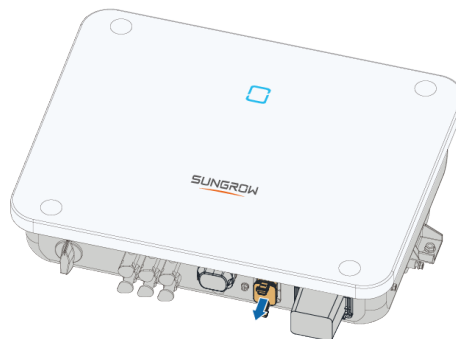

Step 2 Connect the RS485 cable to the communication connector.

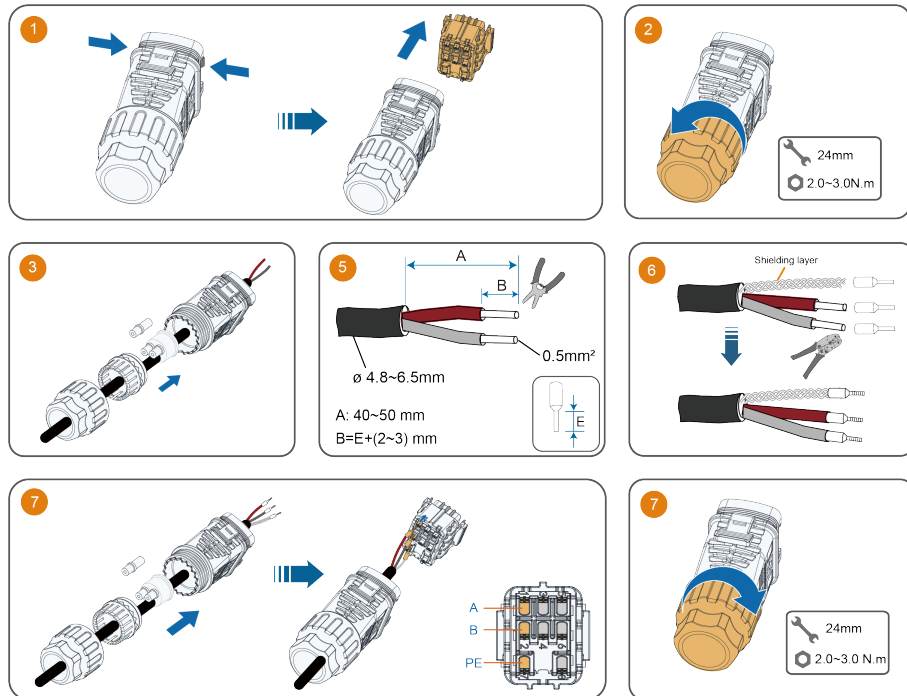

Step 3 Connect the communication connector to the COM2 port of the inverter.

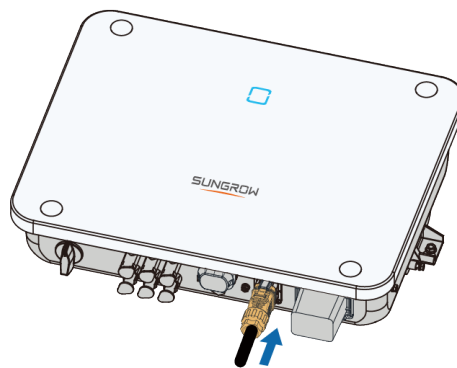

Step 4 Gently tug the cable to ensure all connections are secure.

--End

5.9 Meter Connection

For detailed connection description, refer to the section [5.8 RS485 Connection](#). This section mainly describes the cable connections on the inverter side.

The other end of the communication cable is connected to the RS485A and RS485B ports of the smart meter.



Ensure that the smart meter is compatible with the RS485 interface and the protocol supported by the inverter.

Connection for DTSU666-20

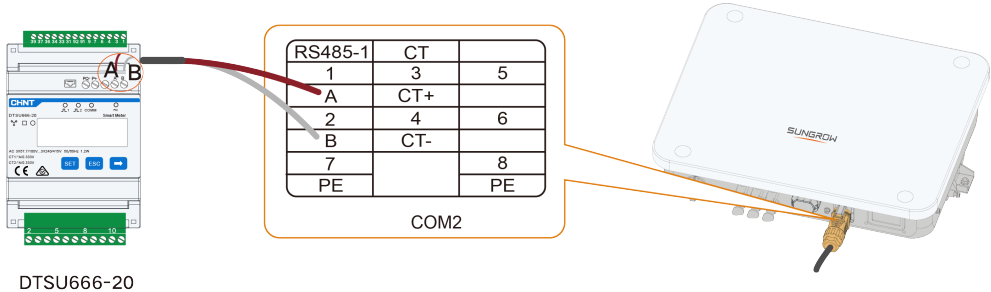

DTSU666-20

If the communication distance (L) ≤ 10 m, use a RS485 communication cable for connection directly.

If $L > 10$ m, add an extra 120Ω resistor to improve the communication quality.

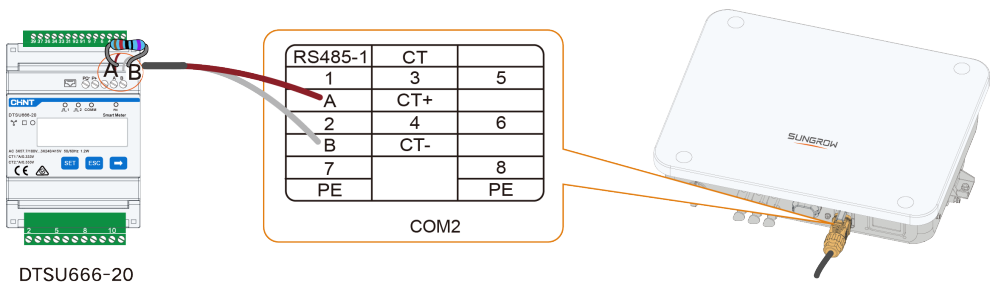

DTSU666-20

5.10 CT Connection

Step 1 Remove the dust cover from the COM2 port of the inverter.

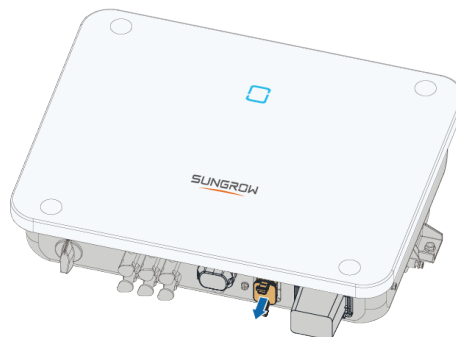

Step 2 Connect the CT cable to the communication connector.



Ensure that CT+ and CT- are connected to the corresponding terminals as per [Table 5-2 Label Description of COM2 Terminal](#) and follow the polarity recommended by the CT manufacturer.

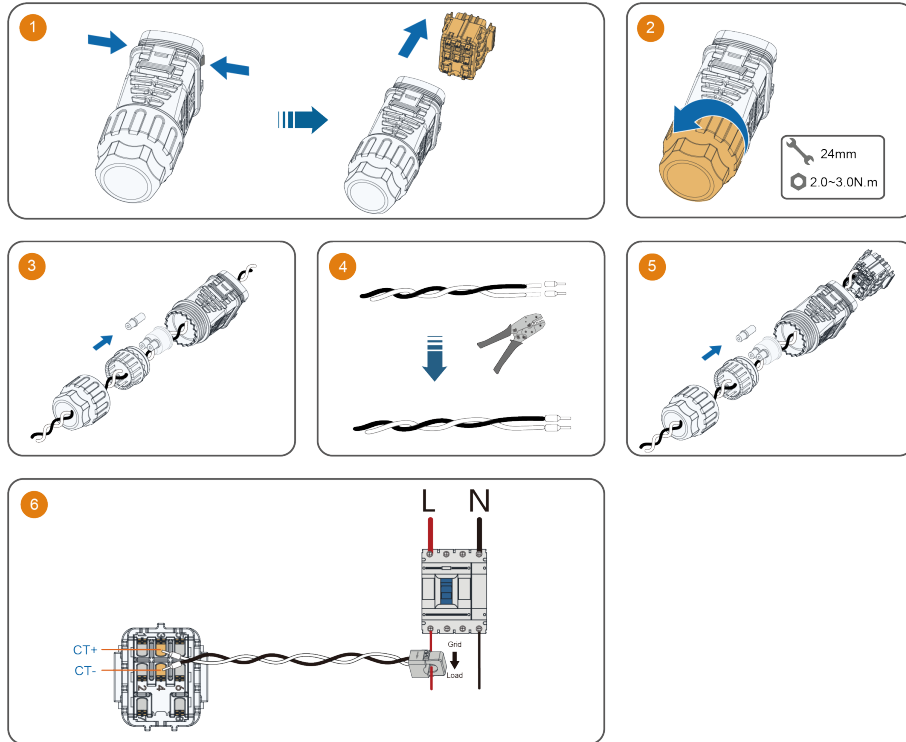

Step 3 Connect the communication connector to the COM2 port of the inverter.

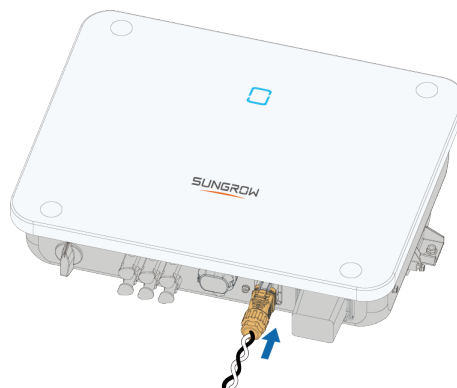

Step 4 Gently tug the cable to ensure all connections are secure.

--End

6 Commissioning

6.1 Inspection Before Commissioning

Check the following items before starting the inverter:

- All equipment has been reliably installed.
- DC switch(es) and AC circuit breaker are in the "OFF" position.
- The ground cable is properly and reliably connected.
- The AC cable is properly and reliably connected.
- The DC cable is properly and reliably connected.
- The communication cable is properly and reliably connected.
- The unused terminals are sealed.
- No foreign items, such as tools, are left on the top of the machine or in the junction box (if there is).
- The AC circuit breaker is selected in accordance with the requirements of this manual and local standards.
- All warning signs & labels are intact and legible.

6.2 Powering on the System

Prerequisite

If all of the items mentioned above meet the requirements, proceed as follows to start up the inverter for the first time.

Strictly follow the preceding sequence. Otherwise, the product may be damaged, and the loss caused is not covered by the warranty.

Step 1 Turn on the AC circuit breaker between the inverter and the grid.



Before closing the AC circuit breaker between the inverter and the power grid, use a multimeter that is set to the AC gear to ensure that the AC voltage is within the specified range. Otherwise, the inverter may be damaged.

Step 2 Rotate the DC switch of the inverter to "ON" position.

Step 3 Turn on the external DC switch (if applicable) between the inverter and the PV string.

Step 4 If the irradiation and grid conditions meet requirements, the inverter will operate normally. Observe the LED indicator to ensure that the inverter operates normally. Refer to [2.4 LED Panel](#) for LED screen introduction and LED indicator definition.

Step 5 Refer to the quick guide for WiFi-P2/EyeS4 for its indicator definition.

--End

7 iSolarCloud App

7.1 About iSolarCloud

The iSolarCloud App is a mobile application used for power plant management. The App provides plant operation analysis service and enables intelligent mobile O&M. It is designed with functions such as plant operation data display, rapid plant access, parameter setting, quick fault location and notification, and power yield and revenue analysis. With iSolarCloud, convenient and efficient end-to-end plant O&M is allowed.

Connection Methods

Users can log in to the App via remote connection or local access for plant monitoring.

Login by Establishing a Direct Connection (Local)

Establish communication between the mobile phone and the WiFi wireless communication module or the inverter's built-in Bluetooth module to enable mobile maintenance of the inverter. After logging into the App, users can check the information about and set parameters for the inverter.

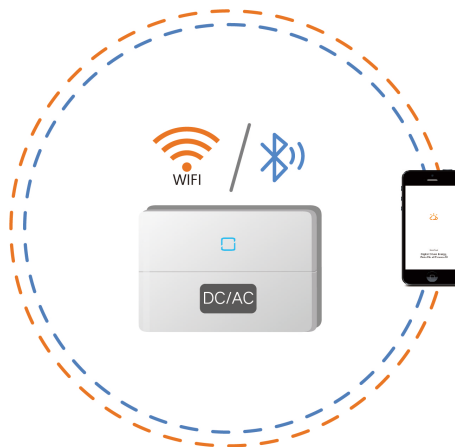

Direct Login (Local)



Login via Bluetooth connection is applicable only for SUNGROW inverters with built-in Bluetooth modules. Please consult your retailer/installer about whether the inverter is equipped with a Bluetooth module.

Login with an Account (Remote)

Establish communication between the communication module and the home router or base station to enable data exchange between the inverter and the cloud server. After logging

into the App, users can check the inverter data or send commands to control the inverter on the App.

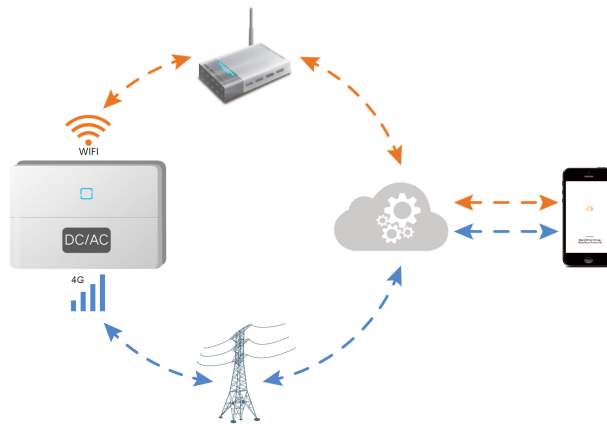

Login Via Account and Password (Remote)

7.2 Install iSolarCloud

Prerequisite

This section introduces how to download and install the iSolarCloud App.

Procedure

- Step 1** Search for **iSolarCloud** in App Store, Google Play or other App stores, or scan the QR code below with a mobile phone and download the App by following the onscreen instructions.



- Step 2** Tap the downloaded installation package and follow the onscreen instructions to complete the installation. The icon of iSolarCloud will then appear on the screen.



--End

7.3 User Roles

After logging into the iSolarCloud App with different roles, users will have varying levels of access to device operations. The default accounts and passwords corresponding to different user roles can be found in [iSolarCloud App User Manual Device Commissioning \(V2.1.6.20250218or Later\)](#) > **Device Connection** > **Device Connection via WLAN** > **Identity Verification**.

For account security purposes, please refer to the **Identity Verification** section to change your password promptly after logging into the iSolarCloud App.

7.4 Device Commissioning

For device commissioning operations, please refer to the **Device Commissioning** in the [iSolarCloud App User Manual](#). Alternatively, you can scan the QR code below to access the **Device Commissioning** section of the manual.



8 System Decommissioning

8.1 Disconnecting the Inverter

⚠ CAUTION

Danger of burns!

Even if the inverter is shut down, it may still be hot and cause burns. Wear protective gloves before operating the inverter after it cools down.

For maintenance or other service work, the inverter must be switched off. Proceed as follows to disconnect the inverter. Lethal voltages or damage to the inverter will follow if otherwise.

Step 1 Disconnect the external AC circuit breaker and prevent it from inadvertent reconnection.

Step 2 Rotate the DC switch to the "OFF" position for disconnecting all of the PV string inputs.

Step 3 Wait about 10 minutes until the capacitors inside the inverter completely discharge.

Step 4 Ensure that the DC cable is current-free with a current clamp.

--End

8.2 Dismantling the Inverter

⚠ CAUTION

Risk of burn injuries and electric shock!

After the inverter is powered off for 10 minutes, measure the voltage and current with professional instrument. Only when there is no voltage nor current can operators who wear protective equipment operate and maintain the inverter.



- Before dismantling the inverter, disconnect the inverter from both AC and DC power sources.
- If there are more than two layers of inverter DC terminals, dismantle the outer DC connectors before dismantling the inner ones.
- If the original packing materials are available, put the inverter inside them and then seal them using adhesive tape. If the original packing materials are not available, put the inverter inside a cardboard box suitable for the weight and size of this inverter and seal it properly.

Step 1 Refer to [5 Electrical Connection](#) to disconnect all cables in reverse steps. In particular, when removing the DC connector, use a connector wrench to loosen the locking parts and install waterproof plugs.

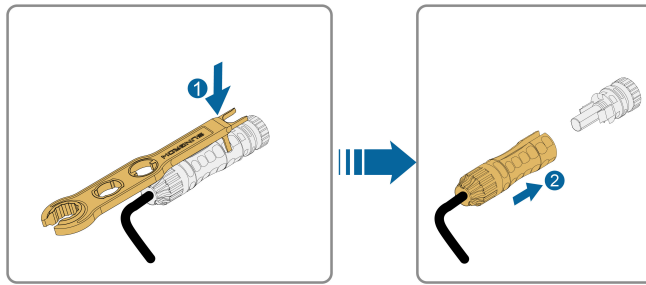

Step 2 Refer to [4 Mechanical Mounting](#), to dismantle the inverter in reverse steps.

Step 3 If necessary, remove the wall-mounting bracket from the wall.

Step 4 If the inverter will be used again in the future, please refer to [3.2 Inverter Storage](#) for a proper conservation.

--End

8.3 Disposal of Inverter

Users take the responsibility for the disposal of the inverter.

⚠ WARNING

Please scrap the inverter in accordance with relevant local regulations and standards to avoid property losses or casualties.

NOTICE

Some parts of the inverter may cause environmental pollution. Please dispose of them in accordance with the disposal regulations for electronic waste applicable at the installation site.

9 Troubleshooting and Maintenance

9.1 Troubleshooting

Once the inverter fails, the fault information is displayed on the App interface. If the inverter is equipped with an LCD screen, the fault information can be viewed on it.

The fault codes and troubleshooting methods of all PV inverters are detailed in the table below, and only some of the faults may occur to the model you purchased. When a fault occurs, you can check the fault information according to the fault code on the mobile app.

Fault Code	Fault Name	Corrective Measures
2, 3, 14, 15	Grid Overvoltage	<p>Generally, the inverter will be reconnected to the grid after the grid returns to normal. If the fault occurs repeatedly:</p> <ol style="list-style-type: none">1. Measure the actual grid voltage, and contact the local electric power company for solutions if the grid voltage is higher than the set value.2. Check whether the protection parameters are appropriately set via the App or the LCD. Modify the overvoltage protection values with the consent of the local electric power operator.3. Contact Sungrow Customer Service if the preceding causes are ruled out and the fault persists.
4, 5	Grid Undervoltage	<p>Generally, the inverter will be reconnected to the grid after the grid returns to normal. If the fault occurs repeatedly:</p> <ol style="list-style-type: none">1. Measure the actual grid voltage, and contact the local electric power company for solutions if the grid voltage is lower than the set value.2. Check whether the protection parameters are appropriately set via the App or the LCD.3. Check whether the AC cable is firmly in place.4. Contact Sungrow Customer Service if the preceding causes are ruled out and the fault persists.

Fault Code	Fault Name	Corrective Measures
8	Grid Overfrequency	<p>Generally, the inverter will be reconnected to the grid after the grid returns to normal. If the fault occurs repeatedly:</p> <ol style="list-style-type: none"> 1. Measure the actual grid frequency, and contact the local electric power company for solutions if the grid frequency is beyond the set range.
9	Grid Underfrequency	<ol style="list-style-type: none"> 2. Check whether the protection parameters are appropriately set via the App or the LCD. 3. Contact Sungrow Customer Service if the preceding causes are ruled out and the fault persists.
10	Grid Power Outage	<p>Generally, the inverter will be reconnected to the grid after the grid returns to normal. If the fault occurs repeatedly:</p> <ol style="list-style-type: none"> 1. Check whether the grid supplies power reliably. 2. Check whether the AC cable is firmly in place. 3. Check whether the AC cable is connected to the correct terminal (whether the live wire and the N wire are correctly in place). 4. Check whether the AC circuit breaker is connected. 5. Contact Sungrow Customer Service if the preceding causes are ruled out and the fault persists.
12	Excess Leakage Current	<ol style="list-style-type: none"> 1. The fault can be caused by poor sunlight or damp environment, and generally the inverter will be reconnected to the grid after the environment is improved. 2. If the environment is normal, check whether the AC and DC cables are well insulated. 3. Contact Sungrow Customer Service if the preceding causes are ruled out and the fault persists.
13	Grid Abnormal	<p>Generally, the inverter will be reconnected to the grid after the grid returns to normal. If the fault occurs repeatedly:</p>

Fault Code	Fault Name	Corrective Measures
		<ol style="list-style-type: none"> 1. Measure the actual grid, and contact the local electric power company for solutions if the grid parameter exceeds the set range. 2. Contact Sungrow Customer Service if the preceding causes are ruled out and the fault persists.
17	Grid Voltage Imbalance	<p>Generally, the inverter will be reconnected to the grid after the grid returns to normal. If the fault occurs repeatedly:</p> <ol style="list-style-type: none"> 1. Measure the actual grid voltage. If grid phase voltages differ greatly, contact the electric power company for solutions. 2. If the voltage difference between phases is within the permissible range of the local power company, modify the grid voltage imbalance parameter through the App or the LCD. 3. Contact Sungrow Customer Service if the preceding causes are ruled out and the fault persists.
28, 29, 208, 212, 448-479	PV Reserve Connection Fault	<ol style="list-style-type: none"> 1. Check whether the corresponding string is of reverse polarity. If so, disconnect the DC switch and adjust the polarity when the string current drops below 0.5 A. 2. Contact Sungrow Customer Service if the preceding causes are ruled out and the fault persists. <p>*The code 28 to code 29 are corresponding to PV1 to PV2 respectively. *The code 448 to code 479 are corresponding to string 1 to string 32 respectively.</p>
532-547, 564-579	PV Reverse Connection Alarm	<ol style="list-style-type: none"> 1. Check whether the corresponding string is of reverse polarity. If so, disconnect the DC switch and adjust the polarity when the string current drops below 0.5 A. 2. Contact Sungrow Customer Service if the preceding causes are ruled out and the alarm persists. <p>*The code 532 to code 547 are corresponding to string 1 to string 16 respectively. *The code 564 to code 579 are corresponding to string 17 to string 32 respectively.</p>

Fault Code	Fault Name	Corrective Measures
548-563, 580-595	PV Abnormal Alarm	<p>Check whether the voltage and current of the inverter is abnormal to determine the cause of the alarm.</p> <ol style="list-style-type: none"> 1. Check whether the corresponding module is sheltered. If so, remove the shelter and ensure module cleanness. 2. Check whether the battery board wiring is loose, if so, make it reliably connected. 3. Check if the DC fuse is damaged. If so, replace the fuse. 4. Contact Sungrow Customer Service if the preceding causes are ruled out and the alarm persists. <p>*The code 548 to code 563 are corresponding to string 1 to string 16 respectively. *The code 580 to code 595 are corresponding to string 17 to string 32 respectively.</p>
37	Excessively High Ambient Temperature	<p>Generally, the inverter will resume operation when the internal or module temperature returns to normal. If the fault persists:</p> <ol style="list-style-type: none"> 1. Check whether the ambient temperature of the inverter is too high; 2. Check whether the inverter is in a well-ventilated place; 3. Check whether the inverter is exposed to direct sunlight. Shield it if so; 4. Check whether the fan is running properly. Replace the fan if not; 5. Contact Sungrow Power Customer Service if the fault is due to other causes and the fault persists.
43	Excessively Low Ambient Temperature	<p>Stop and disconnect the inverter. Restart the inverter when the ambient temperature rises within the operation temperature range.</p>
39	Low System Insulation Resistance	<p>Wait for the inverter to return to normal. If the fault occurs repeatedly:</p> <ol style="list-style-type: none"> 1. Check whether the ISO resistance protection value is excessively high via the app or the LCD, and ensure that it complies with the local regulations.

Fault Code	Fault Name	Corrective Measures
		<ol style="list-style-type: none"> 2. Check the resistance to ground of the string and DC cable. Take corrective measures in case of short circuit or damaged insulation layer. 3. If the cable is normal and the fault occurs on rainy days, check it again when the weather turns fine. 4. If there are batteries, check whether battery cables are damaged and whether terminals are loose or in poor contact. If so, replace the damaged cable and secure terminals to ensure a reliable connection. 5. Contact Sungrow Customer Service if the preceding causes are ruled out and the fault persists.
106	Grounding Cable Fault	<ol style="list-style-type: none"> 1. Check whether the AC cable is correctly connected. 2. Check whether the insulation between the ground cable and the live wire is normal. 3. Contact Sungrow Customer Service if the preceding causes are ruled out and the fault persists.
323	Grid Confrontation	<ol style="list-style-type: none"> 1. Check whether the output port is connected to actual grid. Disconnect it from the grid if so. 2. Contact Sungrow Customer Service if the preceding causes are ruled out and the fault persists.
75	Inverter Parallel Communication Alarm	<ol style="list-style-type: none"> 1. Check whether the communication cable and the terminals are abnormal. If so, correct them to ensure reliable connection. 2. Reconnect the communication cable of the meter. 3. Contact Sungrow Customer Service if the preceding causes are ruled out and the alarm persists.
7, 11, 16, 19–25, 30–34, 36, 38, 40–42, 44–50, 52–58, 60–	System Fault	<ol style="list-style-type: none"> 1. Wait for the inverter to return to normal. 2. Disconnect the AC and DC switches, and disconnect the battery side switches if there are batteries. Close the AC and DC switches in turn 15 minutes later and restart the system.

Fault Code	Fault Name	Corrective Measures
69, 85, 87, 92, 93, 100– 105, 107– 114, 116–124, 200–211, 248–255, 300–322, 324–328, 401–412, 600–603, 605, 608, 612, 616, 620, 622– 624, 800, 802, 804, 807, 1096– 1118		3. Contact Sungrow Customer Service if the preceding causes are ruled out and the fault persists.
59, 70–74, 76–83, 89, 216–218, 220–233, 432–434, 500–513, 515–518, 635–638, 900, 901, 910, 911, 996	System Alarm	<ol style="list-style-type: none"> 1. The inverter can continue running. 2. Check whether the related wiring and terminal are abnormal, check whether there are any foreign materials or other environmental abnormalities, and take corresponding corrective measures when necessary. 3. If the fault persists, please contact Sungrow Power Customer Service.
264-283	MPPT Reverse Connection	<ol style="list-style-type: none"> 1. Check whether the corresponding string is of reverse polarity. If so, disconnect the DC switch and adjust the polarity when the string current drops below 0.5 A. 2. Contact Sungrow Customer Service if the preceding causes are ruled out and the fault persists. <p>*The code 264 to code 279 are corresponding to string 1 to string 20 respectively.</p>
332-363	Boost Capacitor Overvoltage Alarm	<ol style="list-style-type: none"> 1. The inverter can continue running. 2. Check whether the related wiring and terminals are abnormal, check whether there are any foreign materials or other environmental abnormalities, and take

Fault Code	Fault Name	Corrective Measures
		<p>corresponding corrective measures when necessary.</p> <p>If the fault persists, please contact Sungrow Power Customer Service.</p>
364-395	Boost Capacitor Overvoltage Fault	<ol style="list-style-type: none"> 1. Disconnect the AC and DC switches, and disconnect the battery side switches if there are batteries. Close the AC and DC switches in turn 15 minutes later and restart the system. 2. If the fault persists, please contact Sungrow Power Customer Service.
1548-1579	String Current Reflux	<ol style="list-style-type: none"> 1. Check whether the number of PV modules of the corresponding string is less than other strings. If so, disconnect the DC switch and adjust the PV module configuration when the string current drops below 0.5 A. 2. Check whether the PV module is shaded; 3. Disconnect the DC switch to check whether the open circuit voltage is normal when the string current drops below 0.5 A. If so, check the wiring and configuration of the PV module, 4. Check whether the orientation of the PV module is abnormal.
1600 - 1615, 1632 - 1655	PV Grounding Fault	<ol style="list-style-type: none"> 1. When the fault occurs, it is forbidden to directly disconnect the DC switch and unplug PV terminals when the direct current is greater than 0.5 A; 2. Wait until the direct current of the inverter falls below 0.5 A, then disconnect the DC switch and unplug the faulty strings; 3. Do not reinsert the faulty strings before the grounding fault is cleared; 4. If the fault is not caused by the foregoing reasons and still exists, contact Sungrow Customer Service.
1616	System Hardware Fault	<ol style="list-style-type: none"> 1. It is prohibited to disconnect the DC switch when the DC current is greater than 0.5 A when the fault occurs. 2. Disconnect the DC switch only when the inverter DC side current drops below 0.5 A.

Fault Code	Fault Name	Corrective Measures
		3. It is prohibited to power up the inverter again. Please contact Sungrow Customer Service.

9.2 Maintenance

9.2.1 Maintenance Notices

The DC switch can be secured with a lock in the OFF position or a certain angle beyond the OFF position.(For countries “AU” and “NZ”)

DANGER

Risk of inverter damage or personal injury due to incorrect service!

- **Be sure to use special insulation tools when perform high-voltage operations.**
- **Before any service work, first disconnect the grid-side AC circuit breaker and check the inverter status. If the inverter indicator is off, please wait until night to disconnect the DC switch. If the inverter indicator is on, directly disconnect the DC switch.**
- **After the inverter is powered off for 10 minutes, measure the voltage and current with professional instrument. Only when there is no voltage nor current can operators who wear protective equipment operate and maintain the inverter**
- **Even if the inverter is shut down, it may still be hot and cause burns. Wear protective gloves before operating the inverter after it cools down.**
- **When maintaining the product, it is strictly prohibited to open the product if there is an odor or smoke or if the product appearance is abnormal. If there is no odor, smoke, or obvious abnormal appearance, repair or restart the inverter according to the alarm corrective measures. Avoid standing directly in front of the inverter during maintenance.**

CAUTION

To prevent misuse or accidents caused by unrelated personnel: Post prominent warning signs or demarcate safety warning areas around the inverter to prevent accidents caused by misuse.

NOTICE

Restart the inverter only after removing the fault that impairs safety performance. As the inverter contains no component parts that can be maintained, never open the enclosure, or replace any internal components.

To avoid the risk of electric shock, do not perform any other maintenance operations beyond those described in this manual. If necessary, contact your distributor first. If the problem persists, contact SUNGROW. Otherwise, the losses caused is not covered by the warranty.

NOTICE

Touching the PCB or other static sensitive components may cause damage to the device.

- **Do not touch the circuit board unnecessarily.**
- **Observe the regulations to protect against electrostatic and wear an anti-static wrist strap.**

9.2.2 Routine Maintenance

Item	Method	Period
Device clean	Check the temperature and dust of the device. Clean the device enclosure if necessary.	Six months to a year (depending on the dust contents in air)
Electrical connection	Check whether all cable are firmly connected in place. Check whether there is damage to the cables, especially the surface in contact with metal.	6 months after commissioning and then once or twice a year
General status of the system	<ul style="list-style-type: none"> • Visual check for any damage or deformation of the microinverter. • Check any abnormal noise during the operation. • Check each operation parameter. • Be sure that nothing covers the heat sink of the device. 	Every 6 months

10 Appendix

10.1 Technical Data

Parameter	SG7.5RS-L2	SG8.0RS-L2	SG10RS-L2
Input (DC)			
Recommended max. PV input power	11.25 kWp	12 kWp	15 kWp
Max. PV input voltage ⁽¹⁾	600 V		
Min. operating PV voltage / Start-up input voltage	40 V / 50 V		
Rated PV input voltage	360 V		
MPPT operating voltage range ⁽²⁾	40 V – 560 V		
MPP voltage range for rated power	250 V - 480 V	260 V - 480 V	285V - 480V
No. of independent MPP trackers	3		
No. of PV strings per MPPT	1		
Max. PV input current	60 A (20 A / 20 A / 20 A)		
Max. DC short-circuit current	75 A (25 A / 25 A / 25 A)		
Output (AC)			
Rated AC output power	7500 W	8000 W	10000 W
Max. AC output apparent power	7500 VA	8800 VA	11000 VA
Rated AC output current (at 220 V)	34.1 A	36.4 A	45.5 A

Parameter	SG7.5RS-L2	SG8.0RS-L2	SG10RS-L2
Max. AC output current	34.1 A	40 A	50 A
Rated AC voltage	220 / 230 / 240V		
AC voltage range	154 V – 300 V		
Rated grid frequency / Grid frequency range	50 Hz / 45 Hz – 55 Hz, 60 Hz / 55 Hz – 65 Hz		
Harmonic (THD)	< 3 % (at rated power)		
Power factor at rated power / Adjustable power factor	> 0.99 / 0.8 leading - 0.8 lagging		
Feed-in phases / connection phases	1 / 1		
Efficiency			
Max. efficiency / European efficiency	97.0 % / 96.5 %	97.0 % / 96.5 %	97.1 % / 96.6 %
Protection			
Grid monitoring	Yes		
DC reverse polarity protection	Yes		
AC short- circuit protection	Yes		
Arc fault circuit interrupter (AFCI)	Yes		
Leakage current protection	Yes		
Surge Protection	DC type II / AC type II		
DC switch	Yes		
PV string current monitoring	Yes		
PID Zero	Yes		
General Data			

Parameter	SG7.5RS-L2	SG8.0RS-L2	SG10RS-L2
Dimensions (W x H x D)	509 mm x 398 mm x 197 mm		
Weight	≤ 13.5 kg		
Mounting method	Wall-mounting		
Topology	Transformerless		
Degree of protection	IP65		
Night power consumption	< 3W		
Operating ambient temperature range	-25°C to 60°C		
Allowable relative humidity range (non-condensing)	0–100 %		
Cooling method	Natural cooling		
Max. operating altitude	4000 m		
Display	LED indicator		
Communication	WLAN / RS485		
DC connection type	MC4 Compatible Connector (Max. 6 mm ²)		
AC connection type	OT Terminal (Max. 16 mm ²)		
Grid compliance	ABNT NBR 16150, PORTARIA Nº 140, DE 21 DE MARÇO DE 2022 IEC/EN 62109-1/2, IEC 61000-6-1/2/3/4, IEC 62116, IEC 61683, IEC 61727, IEC 60068-2-1/2/14/30/64/27, IEC 60529, EN 50530, IS 16169 / IS 16221(BIS)		
Grid support	Active & reactive power control and power ramp rate control		
Max. inverter backfeed current to the array	0A		
AC Current (inrush)	200A		
Maximum output fault current	200A		

Parameter	SG7.5RS-L2	SG8.0RS-L2	SG10RS-L2
Maximum output overcurrent protection		50A	63A

(1) Input voltage exceeding the MPPT operating voltage range triggers inverter protection.

(2) Please refer to the user manual for the full load MPPT voltage range.

10.2 Quality Assurance

When product faults occur during the warranty period, SUNGROW will provide free service or replace the product with a new one.

Evidence

During the warranty period, the customer shall provide the product purchase invoice and date. In addition, the trademark on the product shall be undamaged and legible. Otherwise, SUNGROW has the right to refuse to honor the quality guarantee.

Conditions

- After replacement, unqualified products shall be processed by SUNGROW.
- The customer shall give SUNGROW a reasonable period to repair the faulty device.

Exclusion of Liability

In the following circumstances, SUNGROW has the right to refuse to honor the quality guarantee:

- The free warranty period for the whole machine/components has expired.
- The device is damaged during transport.
- The device is incorrectly installed, refitted, or used.
- The device operates in harsh conditions beyond those described in this manual.
- The fault or damage is caused by installation, repairs, modification, or disassembly performed by a service provider or personnel not from SUNGROW.
- The fault or damage is caused by the use of non-standard or non-SUNGROW components or software.
- The installation and use range are beyond stipulations of relevant international standards.
- The damage is caused by unexpected natural factors.

For faulty products in any of above cases, if the customer requests maintenance, paid maintenance service may be provided based on the judgment of SUNGROW.



Product data such as product dimensions are subject to change without prior notice. The latest documentation from SUNGROW should take precedence in case of any deviation.

10.3 Contact Information

In case of questions about this product, please contact us. We need the following information to provide you the best assistance:

- Model of the device
- Serial number of the device
- Fault code/name
- Brief description of the problem

For detailed contact information, please visit: <https://en.SUNGROWpower.com/contactUS>

SUNGROW

Sungrow Power Supply Co., Ltd.

www.sungrowpower.com